RF Test Report

Report No.: AGC05443231209ER02

PRODUCT DESIGNATION : Magnetic wireless charger
BRAND NAME : N/A
MODEL NAME : M06874
APPLICANT : MID OCEAN BRANDS B.V
DATE OF ISSUE : Dec. 14, 2023
STANDARD(S) : ETSI EN 303 417 V1.1.1(2017-09)
REPORT VERSION : V1.0

Attestation of Global Compliance (Shenzhen) Co., Ltd.



Any report having not been signed by authorized approver, or having been altered without authorization, or having not been stamped by the "Dedicated Testing/Inspection Stamp" is deemed to be invalid. Copying or excerpting portion of, or altering the content of the report is not permitted without the written authorization of AGC. The test results presented in the report apply only to the tested sample. Any objections to report issued by AGC should be submitted to AGC within 15days after the issuance of the test report. Further enquiry of validity or verification of the test report should be addressed to AGC by agc01@agccert.com.

Attestation of Global Compliance(Shenzhen)Co., Ltd
Attestation of Global Compliance(Shenzhen)Std & Tech Co., Ltd
Tel: +86-755 2523 4088 E-mail: agc@agccert.com Web: <http://www.agccert.com/>



Report Revise Record

Report Version	Revise Time	Issued Date	Valid Version	Notes
V1.0	/	Dec. 14, 2023	Valid	Initial Release

Any report having not been signed by authorized approver, or having been altered without authorization, or having not been stamped by the “Dedicated Testing/Inspection Stamp” is deemed to be invalid. Copying or excerpting portion of, or altering the content of the report is not permitted without the written authorization of AGC. The test results presented in the report apply only to the tested sample. Any objections to report issued by AGC should be submitted to AGC within 15days after the issuance of the test report. Further enquiry of validity or verification of the test report should be addressed to AGC by agc01@agccert.com.

TABLE OF CONTENTS

1. TEST RESULT CERTIFICATION	4
2. EUT DESCRIPTION	5
3. DESCRIPTION OF TEST ITEMS	6
4. TEST FACILITY	6
5. ETSI EN 303 417 REQUIREMENT	7
5.1 TRANSMITTER H-FIELD REQUIREMENTS	7
5.2 OPERATING FREQUENCY RANGES	12
5.3 TRANSMITTER OUT OF BAND (OOB) EMISSIONS	15
5.4 TRANSMITTER SPURIOUS EMISSIONS	18
5.5 RECEIVER BLOCKING	27
6. INTERPRETATION OF MEASUREMENT RESULTS	29
APPENDIX A: PHOTOGRAPHS OF TEST SETUP	30
APPENDIX B: PHOTOGRAPHS OF THE EUT	31

Any report having not been signed by authorized approver, or having been altered without authorization, or having not been stamped by the "Dedicated Testing/Inspection Stamp" is deemed to be invalid. Copying or excerpting portion of, or altering the content of the report is not permitted without the written authorization of AGC. The test results presented in the report apply only to the tested sample. Any objections to report issued by AGC should be submitted to AGC within 15 days after the issuance of the test report. Further enquiry of validity or verification of the test report should be addressed to AGC by agc01@agccert.com.

1. TEST RESULT CERTIFICATION

Applicant	MID OCEAN BRANDS B.V
Address	Unit 201 2/F, . Laford Centre,838 Lai Chi Kok Road, Cheung Sha Wan, Kowloon, Hongkong
Manufacturer	MID OCEAN BRANDS B.V
Address	Unit 201 2/F, . Laford Centre,838 Lai Chi Kok Road, Cheung Sha Wan, Kowloon, Hongkong
Factory	N/A
Address	N/A
Product Designation	Magnetic wireless charger
Brand Name	N/A
Test Model	MO6874
Series Model(s)	N/A
Difference Description	N/A
Date of receipt of test item	Dec. 08, 2023
Date of test	Dec. 08, 2023 to Dec. 14, 2023
Deviation	None
Condition of Test Sample	Normal
Test Result	Pass
Report Template	AGCRT-EC-RF

Note: The test results of this report relate only to the tested sample identified in this report.

Prepared By Thea Huang
 Thea Huang
 (Project Engineer) Dec. 14, 2023

Reviewed By Calvin Liu
 Calvin Liu
 (Reviewer) Dec. 14, 2023

Approved By Max Zhang
 Max Zhang
 (Authorized Officer) Dec. 14, 2023

Any report having not been signed by authorized approver, or having been altered without authorization, or having not been stamped by the “Dedicated Testing/Inspection Stamp” is deemed to be invalid. Copying or excerpting portion of, or altering the content of the report is not permitted without the written authorization of AGC. The test results presented in the report apply only to the tested sample. Any objections to report issued by AGC should be submitted to AGC within 15days after the issuance of the test report. Further enquiry of validity or verification of the test report should be addressed to AGC by agc01@agccert.com.

2. EUT DESCRIPTION

Details of technical specification refer to the description in follows:

Hardware Version	V1.0
Software Version	V1.0
Frequency Band	110KHz-205KHz
OCW	Energy transmission: Low channel 0.946KHz, Middle Channel 0.982kHz, High channel 0.973KHz Data communication: 0.978KHz
Test Channels	Energy transmission: Low channel 114.1KHz, Middle Channel 144.5kHz, High channel 169.9KHz Data communication: 143.64KHz
Antenna Type	Coil Antenna
Operational Mode	Mode 1: base station in stand-by, idle mode Mode 3: communication Mode 4: energy transmission
Wireless Charging Power	15 W Max.
Power Supply	Type C Input: DC5V 2.4A,9V 2A Type C Output: DC 5V 3A,9V 2.22A,12V 1.66A Wireless Output: DC5V 1A,7.5V 1A,9V 1.12A,9V 1.66A Capacity: 5000mAh/18.5Wh

NOTE: 1. For more information, please refer to User's Manual.

2. During the initial establishment of the charging mode (mode 2), no or very low emission occur (below the sensitivity level of the test set-up), so the mode 2 can be assumed as irrelevant for the test.

3. Mode 3 and mode 4 have been performed within one set-up, worst-case alignment. But each mode have been tested separately with specific test software.

4. The maximum temperature of 40 is not a standard requirement and is measured according to the maximum service temperature stated by the manufacturer.

3. DESCRIPTION OF TEST ITEMS

Harmonised Standard ETSI EN 303 417		
Requirement		Requirement Conditionality
No	Description	
1	Permitted range of operating frequencies	<input checked="" type="checkbox"/> Applicable <input type="checkbox"/> Not Applicable
2	Operating frequency ranges	<input checked="" type="checkbox"/> Applicable <input type="checkbox"/> Not Applicable
3	H-field requirements	<input checked="" type="checkbox"/> Applicable <input type="checkbox"/> Not Applicable
4	Transmitter spurious emissions	<input checked="" type="checkbox"/> Applicable <input type="checkbox"/> Not Applicable
5	Transmitter out of band (OOB) emissions	<input checked="" type="checkbox"/> Applicable <input type="checkbox"/> Not Applicable
6	WPT system unwanted conducted emissions	<input type="checkbox"/> Applicable <input checked="" type="checkbox"/> Not Applicable
7	Receiver blocking	<input checked="" type="checkbox"/> Applicable <input type="checkbox"/> Not Applicable

4. TEST FACILITY

Test Site	Attestation of Global Compliance (Shenzhen) Co., Ltd
Location	1-2/F, Building 19, Junfeng Industrial Park, Chongqing Road, Heping Community, Fuhai Street, Bao'an District, Shenzhen, Guangdong, China

Any report having not been signed by authorized approver, or having been altered without authorization, or having not been stamped by the "Dedicated Testing/Inspection Stamp" is deemed to be invalid. Copying or excerpting portion of, or altering the content of the report is not permitted without the written authorization of AGC. The test results presented in the report apply only to the tested sample. Any objections to report issued by AGC should be submitted to AGC within 15days after the issuance of the test report. Further enquiry of validity or verification of the test report should be addressed to AGC by agc01@agccert.com.

Attestation of Global Compliance(Shenzhen)Co., Ltd

Attestation of Global Compliance(Shenzhen)Std & Tech Co., Ltd

Tel: +86-755 2523 4088 E-mail: agc@agccert.com Web: http://www.agccert.com/

5. ETSI EN 303 417 REQUIREMENT

5.1 TRANSMITTER H-FIELD REQUIREMENTS

MEASUREMENT EQUIPMENT USED:

NAME OF EQUIPMENT	MANUFACTURER	MODEL	S/N	Cal. Date	Cal. Due
Test Receiver	R&S	ESCI	10096	Feb. 18, 2023	Feb. 17, 2024
Power amplifier	AR	75A250	18464	N/A	N/A
Active loop antenna(9K-30MHz)	ZHINAN	ZN30900C	18051	Mar. 12, 2022	Mar. 11, 2024

TEST SETUP:

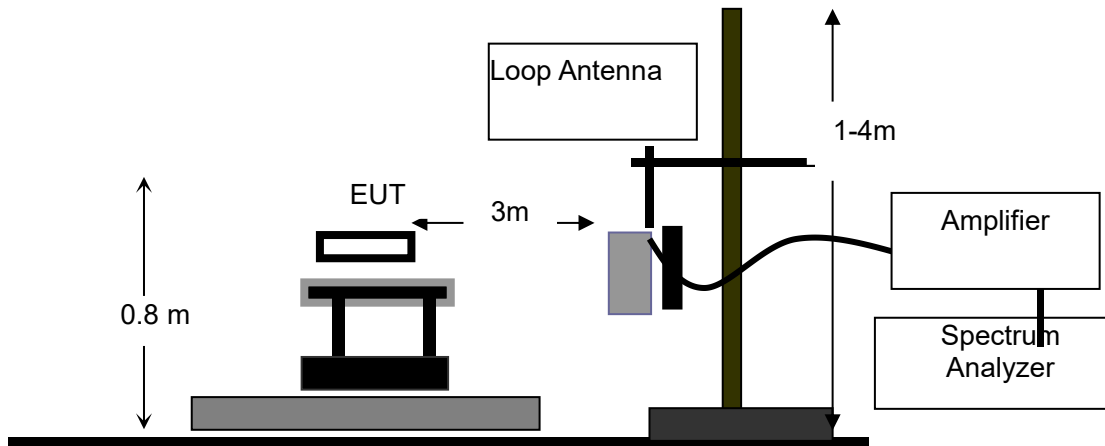

Any report having not been signed by authorized approver, or having been altered without authorization, or having not been stamped by the "Dedicated Testing/Inspection Stamp" is deemed to be invalid. Copying or excerpting portion of, or altering the content of the report is not permitted without the written authorization of AGC. The test results presented in the report apply only to the tested sample. Any objections to report issued by AGC should be submitted to AGC within 15days after the issuance of the test report. Further enquiry of validity or verification of the test report should be addressed to AGC by agc01@agccert.com.

TEST LIMITS:

The H-field limit in dBµA/m at 3 m, H_{3m} , is determined by the following equation:

$$H_{3m} = H_{10m} + C_3 \quad (F.2)$$

Where: H_{10m} is the H-field limit in dBµA/m at 10 m distance according to the present document; and C_3 is a conversion factor in dB determined from figure F.2.

According to EN 303 417 Tablet 3,

Table 3: H-field limits

Frequency range [MHz]	H-field strength limit [dBµA/m at 10 m]	Comments
$0,019 \leq f < 0,021$	72	
$0,059 \leq f < 0,061$	69,1 descending 10 dB/dec above 0,059 MHz	See note 1
$0,079 \leq f < 0,090$	67,8 descending 10 dB/dec above 0,079 MHz	See note 2
$0,100 \leq f < 0,119$	42	
$0,119 \leq f < 0,135$	66 descending 10 dB/dec above 0,119 MHz	See note 1
$0,135 \leq f < 0,140$	42	
$0,140 \leq f < 0,1485$	37,7	
$0,1485 \leq f < 0,30$	-5	
$6,765 \leq f < 6,795$	42	

NOTE 1: Limit is 42 dBµA/m for the following spot frequencies: 60 kHz ± 250 Hz and 129,1 kHz ± 500 Hz.
NOTE 2: At the time of preparation of the present document the feasibility of increased limits for high power wireless power transmission systems to charge vehicles [1.4] was prepared. New specific requirements for such systems (e.g. higher H-field emission limits in the 79 - 90 kHz band) will be reflected within a future revision of the present document.

Correction factor, C_3 , for limits at 3 m distance, dB

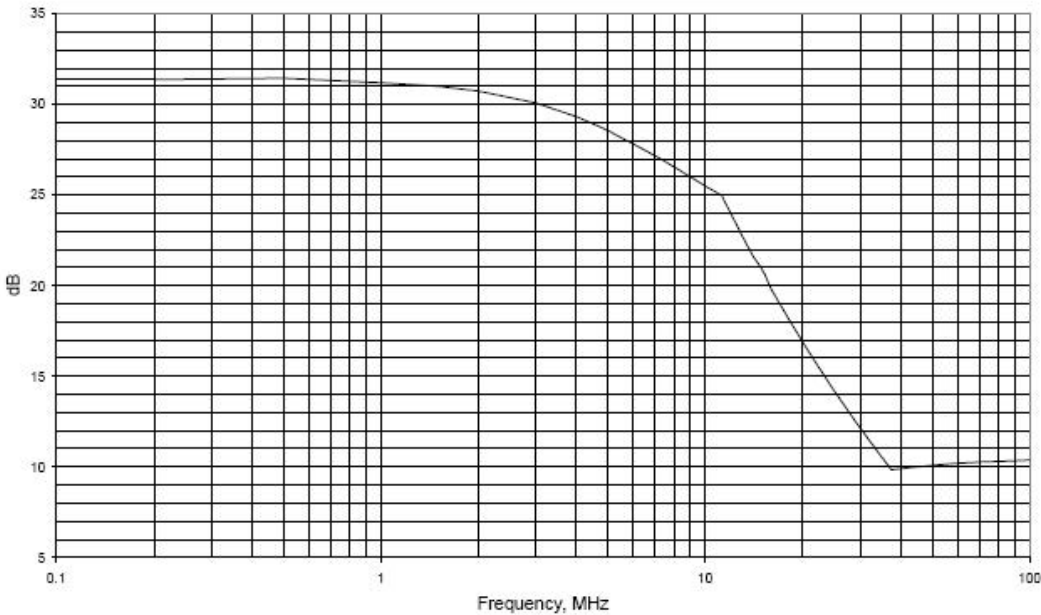

Figure F.2: Conversion factor C_3 versus frequency

Any report having not been signed by authorized approver, or having been altered without authorization, or having not been stamped by the "Dedicated Testing/Inspection Stamp" is deemed to be invalid. Copying or excerpting portion of, or altering the content of the report is not permitted without the written authorization of AGC. The test results presented in the report apply only to the tested sample. Any objections to report issued by AGC should be submitted to AGC within 15 days after the issuance of the test report. Further enquiry of validity or verification of the test report should be addressed to AGC by agc01@agccert.com.

TEST PROCEDURE:

The EUT was placed on the top of an insulating table 0.8 meters above the ground at a semi-anechoic chamber. The table was rotated 360 degrees to determine the position of the highest radiation.

The EUT was set 3 meters away from the interference-receiving antenna, which was mounted on the top of a variable-height antenna tower.

The H-field is measured with a shielded loop antenna connected to a measurement receiver.

The measuring bandwidth and detector type of the measurement receiver shall be in accordance with EN 300 330 V2.1.1 Table 11.

The EUT operate with modulation under normal and extreme conditions.

TEST RESULTS:

Test Mode: Mode 1

Extreme conditions state

conditions	Test Temp	Test Volt.(V)	Note
TN/VN	25°C	9.00	Worst case
TL/VL	-10°C	8.10	
TH/VL	45°C	8.10	
TL/VH	-10°C	9.90	
TH/VH	45°C	9.90	

Test results tested at 3m test sites:

Freq.	Antenna Factor	Reading Level	Corrected Level	Limit
(MHz)	(dB/m)	(dBuA)	(dBuA/m)	(dBuA/m)
0.189	23.53	-0.94	22.59	26.20

Test results calculated to 10m test sites:

Freq.	Antenna Factor	Reading Level	Corrected Level	Limit
(MHz)	(dB/m)	(dBuA)	(dBuA/m)	(dBuA/m)
0.189	23.53	-32.14	-8.61	-5.00

Any report having not been signed by authorized approver, or having been altered without authorization, or having not been stamped by the "Dedicated Testing/Inspection Stamp" is deemed to be invalid. Copying or excerpting portion of, or altering the content of the report is not permitted without the written authorization of AGC. The test results presented in the report apply only to the tested sample. Any objections to report issued by AGC should be submitted to AGC within 15days after the issuance of the test report. Further enquiry of validity or verification of the test report should be addressed to AGC by agc01@agccert.com.

Test Mode: Mode 3

Extreme conditions state

conditions	Test Temp	Test Volt.(V)	Note
TN/VN	25°C	9.00	Worst case
TL/VL	-10°C	8.10	
TH/VL	45°C	8.10	
TL/VH	-10°C	9.90	
TH/VH	45°C	9.90	

Test results tested at 3m test sites:

Freq.	Antenna Factor	Reading Level	Corrected Level	Limit
(MHz)	(dB/m)	(dBuA)	(dBuA/m)	(dBuA/m)
0.14364	23.53	2.65	26.18	68.90

Test results calculated to 10m test sites:

Freq.	Antenna Factor	Reading Level	Corrected Level	Limit
(MHz)	(dB/m)	(dBuA)	(dBuA/m)	(dBuA/m)
0.14364	23.53	-28.55	-5.02	37.70

Any report having not been signed by authorized approver, or having been altered without authorization, or having not been stamped by the "Dedicated Testing/Inspection Stamp" is deemed to be invalid. Copying or excerpting portion of, or altering the content of the report is not permitted without the written authorization of AGC. The test results presented in the report apply only to the tested sample. Any objections to report issued by AGC should be submitted to AGC within 15days after the issuance of the test report. Further enquiry of validity or verification of the test report should be addressed to AGC by agc01@agccert.com.

Attestation of Global Compliance(Shenzhen)Co., Ltd

Attestation of Global Compliance(Shenzhen)Std & Tech Co., Ltd

Tel: +86-755 2523 4088 E-mail: agc@agccert.com Web: http://www.agccert.com/

Test Mode: Mode 4

Extreme conditions state

conditions	Test Temp	Test Volt.(V)	Note
TN/VN	25°C	9.00	Worst case
TL/VL	-10°C	8.10	
TH/VL	45°C	8.10	
TL/VH	-10°C	9.90	
TH/VH	45°C	9.90	

Test results tested at 3m test sites:

Freq.	Antenna Factor	Reading Level	Corrected Level	Limit
(MHz)	(dB/m)	(dBuA)	(dBuA/m)	(dBuA/m)
0.1141	23.53	1.84	25.37	73.20
0.1445	23.53	2.56	26.09	68.90
0.1698	23.53	-8.49	15.04	26.20

Test results calculated to 10m test sites:

Freq.	Antenna Factor	Reading Level	Corrected Level	Limit
(MHz)	(dB/m)	(dBuA)	(dBuA/m)	(dBuA/m)
0.1141	23.53	-29.36	-5.83	42.00
0.1445	23.53	-28.64	-5.11	37.70
0.1698	23.53	-39.69	-16.16	-5.00

Remark:

- (1) Corrected Level (dBuA/m) = Reading Level + Antenna Factor
- (2) For the calculated method, please refer to Annex F at EN 300330.
- (3) All extreme conditions were considered for test, but only record the worst case.

Any report having not been signed by authorized approver, or having been altered without authorization, or having not been stamped by the "Dedicated Testing/Inspection Stamp" is deemed to be invalid. Copying or excerpting portion of, or altering the content of the report is not permitted without the written authorization of AGC. The test results presented in the report apply only to the tested sample. Any objections to report issued by AGC should be submitted to AGC within 15days after the issuance of the test report. Further enquiry of validity or verification of the test report should be addressed to AGC by agc01@agccert.com.

5.2 OPERATING FREQUENCY RANGES

MEASUREMENT EQUIPMENT USED:

NAME OF EQUIPMENT	MANUFACTURER	MODEL	S/N	Cal. Date	Cal. Due
Test Receiver	R&S	ESCI	10096	Feb. 18, 2023	Feb. 17, 2024
Power amplifier	AR	75A250	18464	N/A	N/A
Active loop antenna(9K-30MHz)	ZHINAN	ZN30900C	18051	Mar. 12, 2022	Mar. 11, 2024

TEST SETUP:

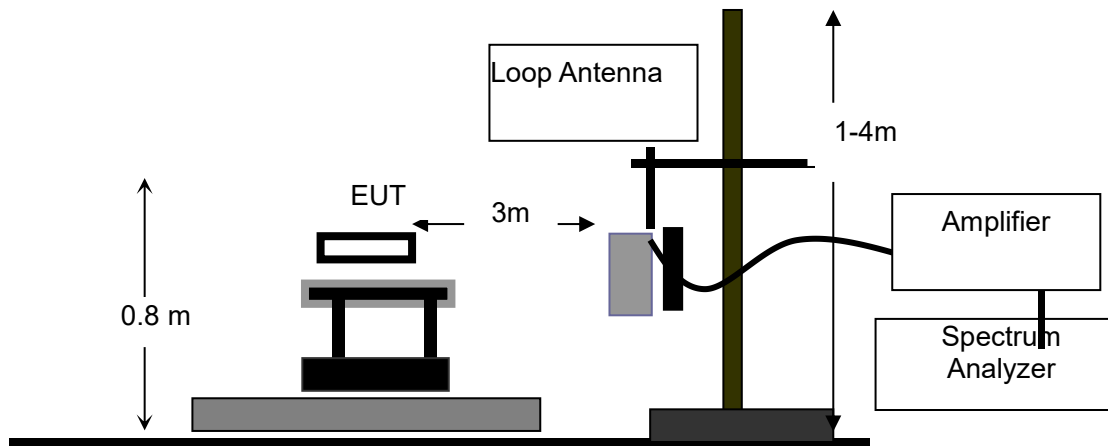

TEST PROCEDURE:

- 1). The EUT was placed on a turn table which is 0.8m above ground plane.
- 2). The EUT was modulated by normal signal,
- 3). Set SPA Center Frequency = fundamental frequency, RBW=VBW=200Hz, Span=5kHz, Detector=RMS. The 99 % OBW function shall be used to determine the operating frequency range, fH is the frequency of the upper marker resulting from the OFR, fL is the frequency of the lower marker resulting from the OFR.
- 4). Both normal test condition and extreme test condition applied

LIMITS

The operating frequency range for emissions shall be within one of the following limits: 19 - 21 kHz, 59 - 61 kHz, 79 - 90 kHz, 100 - 300 kHz, 6 765 - 6 795 kHz.

Any report having not been signed by authorized approver, or having been altered without authorization, or having not been stamped by the "Dedicated Testing/Inspection Stamp" is deemed to be invalid. Copying or excerpting portion of, or altering the content of the report is not permitted without the written authorization of AGC. The test results presented in the report apply only to the tested sample. Any objections to report issued by AGC should be submitted to AGC within 15days after the issuance of the test report. Further enquiry of validity or verification of the test report should be addressed to AGC by agc01@agccert.com.

TEST RESULT

Test Mode: Mode 1

Frequency Range Test Result

Test Temperature	Test Voltage (V DC)	Lowest Frequency(K Hz)	Highest Frequency (KHz)	Limit
-10°C	9.90	188.764	189.240	100kHz≤&≤300kHz
	8.10	188.762	189.238	100kHz≤&≤300kHz
25°C	9.00	188.759	189.241	100kHz≤&≤300kHz
45°C	9.90	188.760	189.240	100kHz≤&≤300kHz
	8.10	188.759	189.240	100kHz≤&≤300kHz
OFR		0.482kHz		
Results		PASS		

Test Mode: Mode 3

Frequency Range Test Result

Test Temperature	Test Voltage (V DC)	Lowest Frequency(K Hz)	Highest Frequency (KHz)	Limit
-10°C	9.90	143.152	144.126	100kHz≤&≤300kHz
	8.10	143.154	144.127	100kHz≤&≤300kHz
25°C	9.00	143.151	144.129	100kHz≤&≤300kHz
45°C	9.90	143.154	144.129	100kHz≤&≤300kHz
	8.10	143.153	144.125	100kHz≤&≤300kHz
OFR		0.978kHz		
Results		PASS		

Any report having not been signed by authorized approver, or having been altered without authorization, or having not been stamped by the "Dedicated Testing/Inspection Stamp" is deemed to be invalid. Copying or excerpting portion of, or altering the content of the report is not permitted without the written authorization of AGC. The test results presented in the report apply only to the tested sample. Any objections to report issued by AGC should be submitted to AGC within 15days after the issuance of the test report. Further enquiry of validity or verification of the test report should be addressed to AGC by agc01@agccert.com.

Attestation of Global Compliance(Shenzhen)Co., Ltd

Attestation of Global Compliance(Shenzhen)Std & Tech Co., Ltd

Tel: +86-755 2523 4088 E-mail: agc@agccert.com Web: http://www.agccert.com/

Test Mode: Mode 4

Frequency Range Test Result

Test Temperature	Test Voltage (V DC)	Lowest Frequency(K Hz)	Highest Frequency (KHz)	Limit
-10°C	9.90	113.630	170.286	100kHz≤&≤300kHz
	8.10	113.632	170.283	100kHz≤&≤300kHz
25°C	9.00	113.627	170.287	100kHz≤&≤300kHz
45°C	9.90	113.627	170.285	100kHz≤&≤300kHz
	8.10	113.631	170.282	100kHz≤&≤300kHz
OFR		56.660kHz		
Results		PASS		

NOTE: All the modes had been tested, but only the worst data recorded in the report.

Any report having not been signed by authorized approver, or having been altered without authorization, or having not been stamped by the "Dedicated Testing/Inspection Stamp" is deemed to be invalid. Copying or excerpting portion of, or altering the content of the report is not permitted without the written authorization of AGC. The test results presented in the report apply only to the tested sample. Any objections to report issued by AGC should be submitted to AGC within 15days after the issuance of the test report. Further enquiry of validity or verification of the test report should be addressed to AGC by agc01@agccert.com.

Attestation of Global Compliance(Shenzhen)Co., Ltd

Attestation of Global Compliance(Shenzhen)Std & Tech Co., Ltd

Tel: +86-755 2523 4088 E-mail: agc@agccert.com Web: http://www.agccert.com/

5.3 TRANSMITTER OUT OF BAND (OOB) EMISSIONS

MEASUREMENT EQUIPMENT USED:

NAME OF EQUIPMENT	MANUFACTURER	MODEL	S/N	Cal. Date	Cal. Due
Test Receiver	R&S	ESCI	10096	Feb. 18, 2023	Feb. 17, 2024
Power amplifier	AR	75A250	18464	N/A	N/A
Active Loop Antenna (9K-30Mhz)	ZHINAN	ZN30900C	18051	Mar. 12, 2022	Mar. 11, 2024

TEST SETUP:

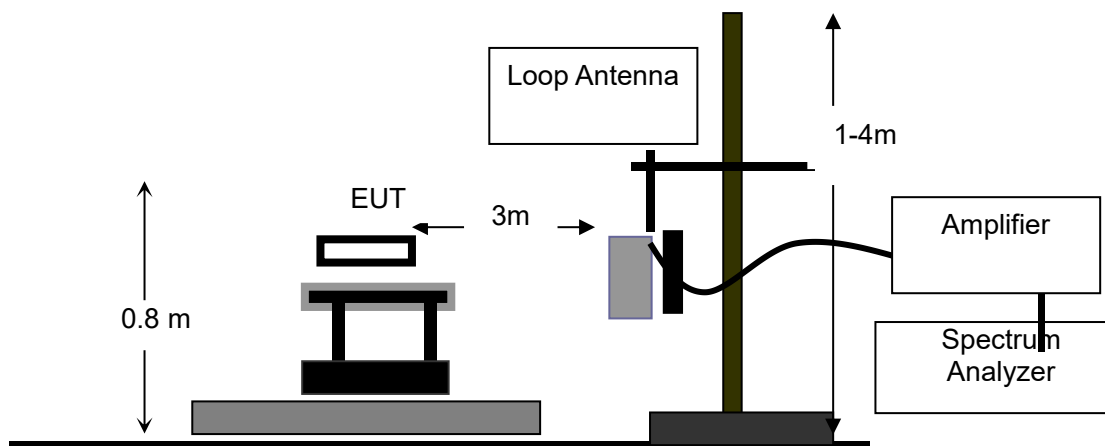

TEST PROCEDURE:

- 1). The EUT was placed on a turn table which is 0.8m above ground plane.
- 2). The EUT was modulated by normal signal,
- 3). Set SPA Center Frequency = fundamental frequency, RBW=VBW=200Hz, Span=5KHz, Detector=RMS. The 99 % OBW function shall be used to determine the operating frequency range, fH is the frequency of the upper marker resulting from the OFR, fL is the frequency of the lower marker resulting from the OFR.
- 4). Both normal test condition and extreme test condition applied

Any report having not been signed by authorized approver, or having been altered without authorization, or having not been stamped by the "Dedicated Testing/Inspection Stamp" is deemed to be invalid. Copying or excerpting portion of, or altering the content of the report is not permitted without the written authorization of AGC. The test results presented in the report apply only to the tested sample. Any objections to report issued by AGC should be submitted to AGC within 15days after the issuance of the test report. Further enquiry of validity or verification of the test report should be addressed to AGC by agc01@agccert.com.

LIMITS

The OOB limits are visualized in figures; they are descending from the intentional limits from Table 3 at fH/fL with 10 dB/decade.

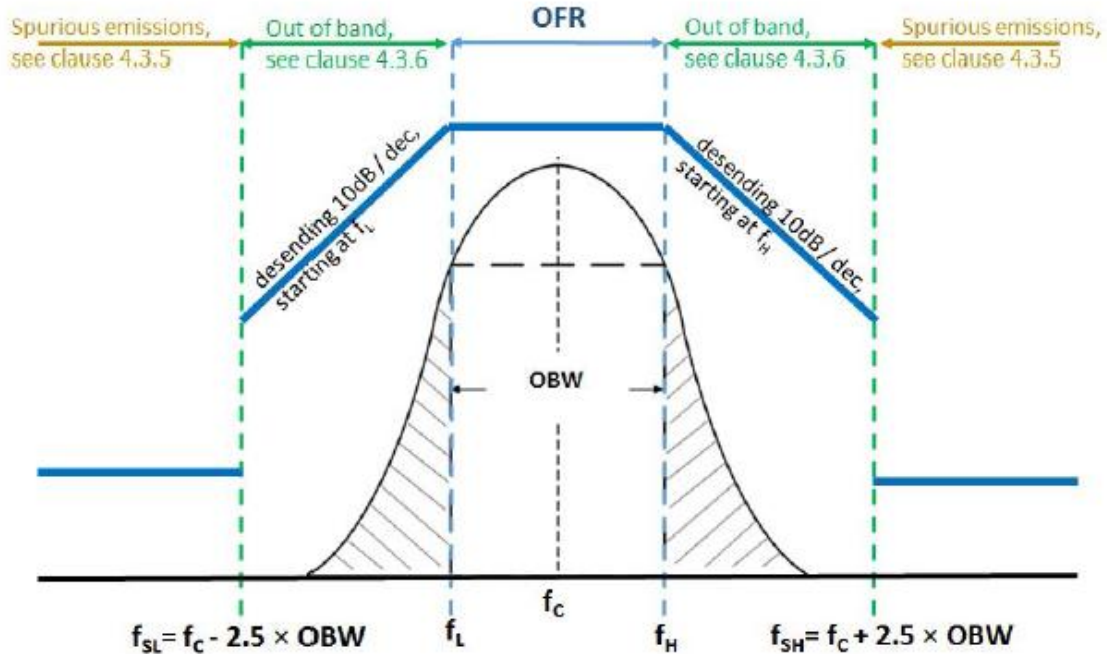

Figure 4: Out of band and spurious domain of a single frequency WPT system

TEST RESULT

Test Mode: Mode 1

Frequency range (KHz)	Maximum level @10m (dBuA/m)	Limit @ 10m (dBuA/m)	Result	
fSL -fL	187.795 to 188.759	Less than -17.77	See figure 4	Pass
fL	188.759	-17.77	-5.00	Pass
fH	189.241	-18.29	-5.00	Pass
fH - fSH	189.241 to 190.205	Less than -18.29	See figure 4	Pass

Test Mode: Mode 3

Frequency range (KHz)	Maximum level @10m (dBuA/m)	Limit @ 10m (dBuA/m)	Result	
fSL-fL	141.195 to 143.151	Less than -14.18	See figure 4	Pass
fL	143.151	-14.18	37.70	Pass
fH	144.129	-14.70	37.70	Pass
fH-fSH	144.129 to 146.085	Less than -14.7	See figure 4	Pass

Any report having not been signed by authorized approver, or having been altered without authorization, or having not been stamped by the "Dedicated Testing/Inspection Stamp" is deemed to be invalid. Copying or excerpting portion of, or altering the content of the report is not permitted without the written authorization of AGC. The test results presented in the report apply only to the tested sample. Any objections to report issued by AGC should be submitted to AGC within 15days after the issuance of the test report. Further enquiry of validity or verification of the test report should be addressed to AGC by agc01@agccert.com.

Attestation of Global Compliance(Shenzhen)Co., Ltd

Attestation of Global Compliance(Shenzhen)Std & Tech Co., Ltd

Tel: +86-755 2523 4088 E-mail: agc@agccert.com Web: http://www.agccert.com/

Test Mode: Mode 4

Frequency range (KHz)		Maximum level @10m (dBuA/m)	Limit @ 10m (dBuA/m)	Result
fSL-fL	111.735 to 113.627	Less than -14.99	See figure 4	Pass
fL	113.627	-14.99	42.00	Pass
fH	170.287	-25.84	-5.00	Pass
fH-fSH	170.287 to 172.233	Less than -25.84	See figure 4	Pass

NOTE: All the modes had been tested, but only the worst data recorded in the report.

Any report having not been signed by authorized approver, or having been altered without authorization, or having not been stamped by the "Dedicated Testing/Inspection Stamp" is deemed to be invalid. Copying or excerpting portion of, or altering the content of the report is not permitted without the written authorization of AGC. The test results presented in the report apply only to the tested sample. Any objections to report issued by AGC should be submitted to AGC within 15days after the issuance of the test report. Further enquiry of validity or verification of the test report should be addressed to AGC by agc01@agccert.com.

Attestation of Global Compliance(Shenzhen)Co., Ltd

Attestation of Global Compliance(Shenzhen)Std & Tech Co., Ltd

Tel: +86-755 2523 4088 E-mail: agc@agccert.com Web: http://www.agccert.com/

5.4 TRANSMITTER SPURIOUS EMISSIONS

MEASUREMENT EQUIPMENT USED:

NAME OF EQUIPMENT	MANUFACTURER	MODEL	S/N	Cal. Date	Cal. Due
Test Receiver	R&S	ESCI	10096	Feb. 18, 2023	Feb. 17, 2024
Power amplifier	AR	75A250	18464	N/A	N/A
Active Loop Antenna (9K-30Mhz)	ZHINAN	ZN30900C	18051	Mar. 12, 2022	Mar. 11, 2024
Wideband Antenna	SCHWARZBECK	VULB9168	VULB9168-494	Jan. 05, 2023	Jan. 04, 2025

TEST SETUP:

FREQUENCY RANGE (9KHZ-30MHZ)

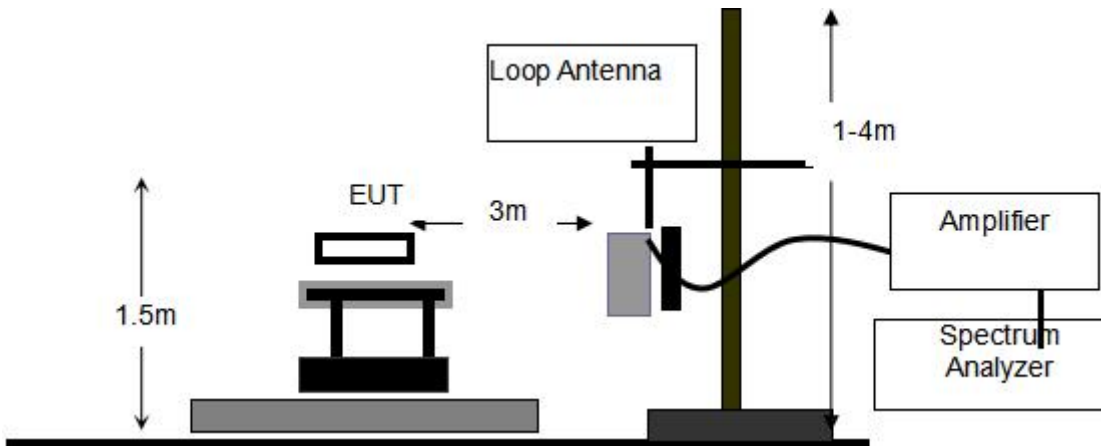

FREQUENCY RANGE (ABOVE 30MHZ)

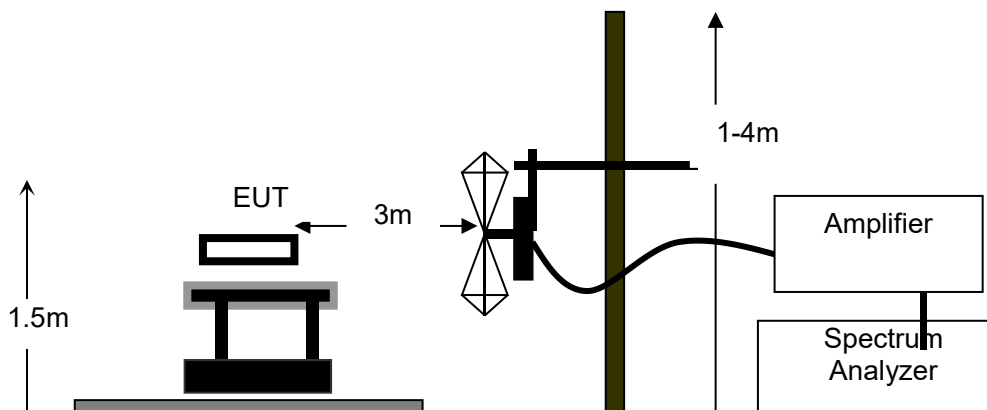

Any report having not been signed by authorized approval or having been altered without authorization is deemed to be invalid. Copying or excerpting portion of, or altering the content of the report is not permitted without the written authorization of AGC. The test results presented in the report apply only to the tested sample. Any objections to report issued by AGC should be submitted to AGC within 15days after the issuance of the test report. Further enquiry of validity or verification of the test report should be addressed to AGC by agc01@agccert.com.

SUBSTITUTION METHOD:

RADIATED BELOW 1GHZ

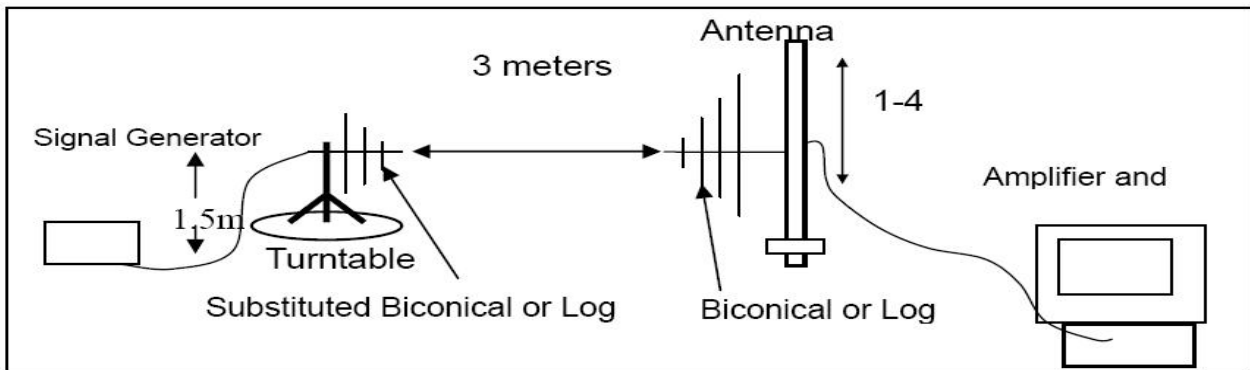

TEST PROCEDURE:

For test method of frequency range (9kHz-30MHz)

The EUT was placed on the top of an insulating table 1.5 meters above the ground at a semi-anechoic chamber. The table was rotated 360 degrees to determine the position of the highest radiation.

The EUT was set 3 meters away from the interference-receiving antenna, which was mounted on the top of a variable-height antenna tower.

The H-field is measured with a shielded loop antenna connected to a measurement receiver.

The measuring bandwidth and detector type of the measurement receiver shall be in accordance with EN 300 330 Table 1.

For test method of frequency range (30 MHz-1000MHz)

EUT was placed on a 1.5m height wooden table. The search antenna is placed at 3m distances from the EUT and search antenna height is from 1-4m. With the transmitter operating at continuously mode, the turntable was slowly rotated to locate the direction of maximum emission. Once maximum direction is determined, the search antenna was raised and lowered in both vertical and horizontal polarizations.

The EUT was removed from the turntable and replaced with a linearly polarized antenna connected to a calibrated RF signal generator. The RF generator was set to a measured emission frequency and the search antenna was raised and lowered to produce a maximum received reading. The generator output was increased to match the radiated emission reading measured previously, and the result expressed in dB EIRP or ERP, correcting for substitution antenna gain at each frequency.

Any report having not been signed by authorized approver, or having been altered without authorization, or having not been stamped by the "Dedicated Testing/Inspection Stamp" is deemed to be invalid. Copying or excerpting portion of, or altering the content of the report is not permitted without the written authorization of AGC. The test results presented in the report apply only to the tested sample. Any objections to report issued by AGC should be submitted to AGC within 15days after the issuance of the test report. Further enquiry of validity or verification of the test report should be addressed to AGC by agc01@agccert.com.

LIMITS OF RADIATED DISTURBANCES

Below 30MHz

Table 4

State (see note)	Frequency $9 \text{ kHz} \leq f < 10 \text{ MHz}$	Frequency $10 \text{ MHz} \leq f < 30 \text{ MHz}$
Operating	27 dB μ A/m at 9 kHz descending 10 dB/dec	-3,5 dB μ A/m
Standby	5,5 dB μ A/m at 9 kHz descending 10 dB/dec	-25 dB μ A/m
NOTE: "Operating" means mode 2, 3 and 4 according to Table 2; "standby" means mode 1 according to Table 2.		

ABOVE 30MHz

Table 5

State (see note)	47 MHz to 74 MHz 87,5 MHz to 118 MHz 174 MHz to 230 MHz 470 MHz to 790 MHz	Other frequencies between 30 MHz to 1 000 MHz
Operating	4 nW	250 nW
Standby	2 nW	2 nW
NOTE: "Operating" means mode 2, 3 and 4 according to Table 2; "standby" means mode 1 according to Table 2.		

Any report having not been signed by authorized approver, or having been altered without authorization, or having not been stamped by the "Dedicated Testing/Inspection Stamp" is deemed to be invalid. Copying or excerpting portion of, or altering the content of the report is not permitted without the written authorization of AGC. The test results presented in the report apply only to the tested sample. Any objections to report issued by AGC should be submitted to AGC within 15days after the issuance of the test report. Further enquiry of validity or verification of the test report should be addressed to AGC by agc01@agccert.com.

TEST LIMITS & RESULT
Test Mode: Mode 3
FREQUENCY RANGE (9KHZ-30MHZ)

Operation Mode					
Frequency	Reading level	Total Factor	Emission level	Limit	Margin
(MHz)	(dB μ A)	(dB/m)	(dB μ A/m)	(dB μ A/m)	(dB μ A/m)
0.026	-7.70	-7.96	-15.66	22.41	38.08
0.236	-11.14	-7.96	-19.10	12.81	31.91
0.783	-12.43	-7.96	-20.39	7.60	28.00
2.097	-14.32	-3.98	-18.30	3.33	21.63
3.530	-13.25	-3.09	-16.34	1.07	17.41
3.320	-12.76	-1.25	-14.01	1.33	15.34

Remark:

- (1) Corrected Power (dBm)= Total Factor + Reading Level
- (2) Measuring frequencies from 9KHz to the 30MHz.
- (3) Data of measurement within this frequency range shown “ -- ” in the table above means the reading of emissions are attenuated more than 20dB below the permissible limits or the field strength is too small to be measured.

Any report having not been signed by authorized approver, or having been altered without authorization, or having not been stamped by the “Dedicated Testing/Inspection Stamp” is deemed to be invalid. Copying or excerpting portion of, or altering the content of the report is not permitted without the written authorization of AGC. The test results presented in the report apply only to the tested sample. Any objections to report issued by AGC should be submitted to AGC within 15days after the issuance of the test report. Further enquiry of validity or verification of the test report should be addressed to AGC by agc01@agccert.com.

Attestation of Global Compliance(Shenzhen)Co., Ltd

Attestation of Global Compliance(Shenzhen)Std & Tech Co., Ltd

Tel: +86-755 2523 4088 E-mail: agc@agccert.com Web: http://www.agccert.com/

FREQUENCY RANGE (ABOVE 30MHZ)

Transmitter Spurious Emission below 1GHz (30MHz-1GHz)

Frequency	Reading Level	Antenna	S.G.	Cable Loss	Ant.Gain	Emission Level	Limit	Margin
(MHz)	(dBuV/m)	Polarization	(dBm)	(dB)	(dBi)	(dBm)	(dBm)	(dB)
84.94	30.76	V	-58.75	0.48	0.54	-58.69	-36.00	22.69
129.95	31.13	V	-58.78	0.49	0.14	-59.13	-36.00	23.13
239.72	30.71	V	-65.33	0.52	6.60	-59.25	-36.00	23.25
326.09	30.09	V	-67.39	0.53	6.10	-61.82	-36.00	25.82
334.44	31.49	V	-64.40	0.53	5.94	-58.99	-36.00	22.99
827.16	31.70	V	-64.92	0.66	6.45	-59.12	-36.00	23.12
84.19	31.77	H	-60.96	0.48	0.54	-60.90	-36.00	24.90
131.86	30.17	H	-58.83	0.49	0.08	-59.24	-36.00	23.24
243.18	29.66	H	-65.90	0.52	6.78	-59.64	-36.00	23.64
325.51	30.47	H	-66.31	0.53	6.10	-60.74	-36.00	24.74
735.38	30.88	H	-65.99	0.59	6.60	-59.98	-36.00	23.98
828.03	30.74	H	-66.30	0.66	6.40	-60.56	-36.00	24.56

Note: 1.The margins of the other spectrum are not exceeding the minimum value of margin, and this part of the results without recording in the test report.

2. Measurements above show only up to 6 maximum emissions noted, or would be lesser, with "--" remark, if no specific emission from the EUT are recorded (ie: margin>20dB from the applicable limit) and considered that's already beyond the background noise floor.

Any report having not been signed by authorized approver, or having been altered without authorization, or having not been stamped by the "Dedicated Testing/Inspection Stamp" is deemed to be invalid. Copying or excerpting portion of, or altering the content of the report is not permitted without the written authorization of AGC. The test results presented in the report apply only to the tested sample. Any objections to report issued by AGC should be submitted to AGC within 15days after the issuance of the test report. Further enquiry of validity or verification of the test report should be addressed to AGC by agc01@agccert.com.

Attestation of Global Compliance(Shenzhen)Co., Ltd

Attestation of Global Compliance(Shenzhen)Std & Tech Co., Ltd

Tel: +86-755 2523 4088 E-mail: agc@agccert.com Web: http://www.agccert.com/

Test Mode: Mode 4(The low channel is the worst case)
FREQUENCY RANGE (9KHZ-30MHZ)

Operation Mode					
Frequency	Reading level	Total Factor	Emission level	Limit	Margin
(MHz)	(dB μ A)	(dB/m)	(dB μ A/m)	(dB μ A/m)	(dB μ A/m)
0.050	-7.82	-7.96	-15.78	19.52	35.31
0.234	-11.08	-7.96	-19.04	12.85	31.89
0.857	-12.59	-7.96	-20.55	7.21	27.76
1.524	-14.77	-3.98	-18.75	4.71	23.46
3.264	-13.40	-3.09	-16.49	1.40	17.90
4.352	-12.39	-1.25	-13.64	0.16	13.79

Remark:

- (1) Corrected Power (dBm) = Total Factor + Reading Level
- (2) Measuring frequencies from 9KHz to the 30MHz.
- (3) Data of measurement within this frequency range shown "--" in the table above means the reading of emissions are attenuated more than 20dB below the permissible limits or the field strength is too small to be measured.

Any report having not been signed by authorized approver, or having been altered without authorization, or having not been stamped by the "Dedicated Testing/Inspection Stamp" is deemed to be invalid. Copying or excerpting portion of, or altering the content of the report is not permitted without the written authorization of AGC. The test results presented in the report apply only to the tested sample. Any objections to report issued by AGC should be submitted to AGC within 15days after the issuance of the test report. Further enquiry of validity or verification of the test report should be addressed to AGC by agc01@agccert.com.

FREQUENCY RANGE (ABOVE 30MHZ)

Transmitter Spurious Emission below 1GHz (30MHz-1GHz)

Frequency	Reading Level	Antenna	S.G.	Cable Loss	Ant.Gain	Emission Level	Limit	Margin
(MHz)	(dBuv/m)	Polarization	(dBm)	(dB)	(dBi)	(dBm)	(dBm)	(dB)
84.73	30.68	V	-61.65	0.48	0.54	-61.59	-36.00	25.59
130.35	30.65	V	-58.23	0.49	0.10	-58.62	-36.00	22.62
239.51	31.22	V	-66.99	0.52	6.60	-60.91	-36.00	24.91
326.51	30.88	V	-64.65	0.53	6.10	-59.08	-36.00	23.08
334.89	31.45	V	-66.54	0.53	5.94	-61.13	-36.00	25.13
827.81	31.43	V	-65.15	0.66	6.45	-59.35	-36.00	23.35
84.26	32.10	H	-60.70	0.48	0.54	-60.64	-36.00	24.64
131.82	30.94	H	-60.06	0.49	0.08	-60.47	-36.00	24.47
242.40	29.89	H	-67.37	0.52	6.72	-61.17	-36.00	25.17
326.19	30.71	H	-67.98	0.53	6.10	-62.41	-36.00	26.41
735.23	30.91	H	-64.79	0.59	6.60	-58.79	-36.00	22.79
827.87	30.86	H	-67.82	0.66	6.45	-62.03	-36.00	26.03

Note: 1.The margins of the other spectrum are not exceeding the minimum value of margin, and this part of the results without recording in the test report.

2. Measurements above show only up to 6 maximum emissions noted, or would be lesser, with "--" remark, if no specific emission from the EUT are recorded (ie: margin>20dB from the applicable limit) and considered that's already beyond the background noise floor.

Test Mode: Mode 1
FREQUENCY RANGE (9KHZ-30MHZ)

Standby Mode					
Frequency	Reading level	Total Factor	Emission level	Limit	Margin
(MHz)	(dB μ A)	(dB/m)	(dB μ A/m)	(dB μ A/m)	(dB μ A/m)
0.046	-7.60	-7.96	-15.56	-1.56	14.00
0.230	-10.23	-7.96	-18.19	-8.57	9.62
0.457	-11.59	-7.96	-19.55	-11.55	8.00
1.630	-23.09	-3.98	-27.07	-17.08	9.99
2.825	-27.67	-3.09	-30.76	-19.47	11.29
5.781	-26.85	-1.25	-28.10	-22.58	5.52

Remark:

- (1) Corrected Power (dBm) = Total Factor + Reading Level
- (2) Measuring frequencies from 9KHz to the 30MHz.
- (3) Data of measurement within this frequency range shown "--" in the table above means the reading of emissions are attenuated more than 20dB below the permissible limits or the field strength is too small to be measured.

Any report having not been signed by authorized approver, or having been altered without authorization, or having not been stamped by the "Dedicated Testing/Inspection Stamp" is deemed to be invalid. Copying or excerpting portion of, or altering the content of the report is not permitted without the written authorization of AGC. The test results presented in the report apply only to the tested sample. Any objections to report issued by AGC should be submitted to AGC within 15days after the issuance of the test report. Further enquiry of validity or verification of the test report should be addressed to AGC by agc01@agccert.com.

FREQUENCY RANGE (ABOVE 30MHZ)

Transmitter Spurious Emission below 1GHz (30MHz-1GHz)

Frequency	Reading Level	Antenna	S.G.	Cable Loss	Ant.Gain	Emission Level	Limit	Margin
(MHz)	(dBuv/m)	Polarization	(dBm)	(dB)	(dBi)	(dBm)	(dBm)	(dB)
85.07	30.76	V	-60.82	0.48	0.70	-60.60	-36.00	24.60
129.67	30.33	V	-60.59	0.49	0.14	-60.94	-36.00	24.94
240.40	30.79	V	-65.44	0.52	6.60	-59.36	-36.00	23.36
326.14	30.38	V	-66.23	0.53	6.10	-60.66	-36.00	24.66
334.70	31.20	V	-67.22	0.53	5.94	-61.81	-36.00	25.81
827.44	31.56	V	-66.67	0.66	6.45	-60.87	-36.00	24.87
83.99	31.79	H	-58.43	0.48	0.38	-58.53	-36.00	22.53
131.46	30.62	H	-60.71	0.49	0.08	-61.12	-36.00	25.12
242.45	29.70	H	-68.87	0.52	6.72	-62.67	-36.00	26.67
326.18	31.06	H	-63.99	0.53	6.10	-58.42	-36.00	22.42
735.39	30.96	H	-65.80	0.59	6.60	-59.79	-36.00	23.79
828.17	31.10	H	-66.28	0.66	6.40	-60.54	-36.00	24.54

Note: 1.The margins of the other spectrum are not exceeding the minimum value of margin, and this part of the results without recording in the test report.

2. Measurements above show only up to 6 maximum emissions noted, or would be lesser, with "--" remark, if no specific emission from the EUT are recorded (ie: margin>20dB from the applicable limit) and considered that's already beyond the background noise floor.

5.5 RECEIVER BLOCKING

MEASUREMENT EQUIPMENT USED:

NAME OF EQUIPMENT	MANUFACTURER	MODEL	S/N	Cal. Date	Cal. Due
MXG X-Series Vector Signal Generator	Agilent	N5182B	MY53050647	Mar. 03, 2023	Mar. 02, 2024
Active Loop Antenna (9K-30Mhz)	ZHINAN	ZN30900C	18051	Mar. 12, 2022	Mar. 11, 2024
Clamp meter	PROVA	PROVA-11	17200101	Sep. 14, 2023	Sep. 13, 2024

TEST SETUP:

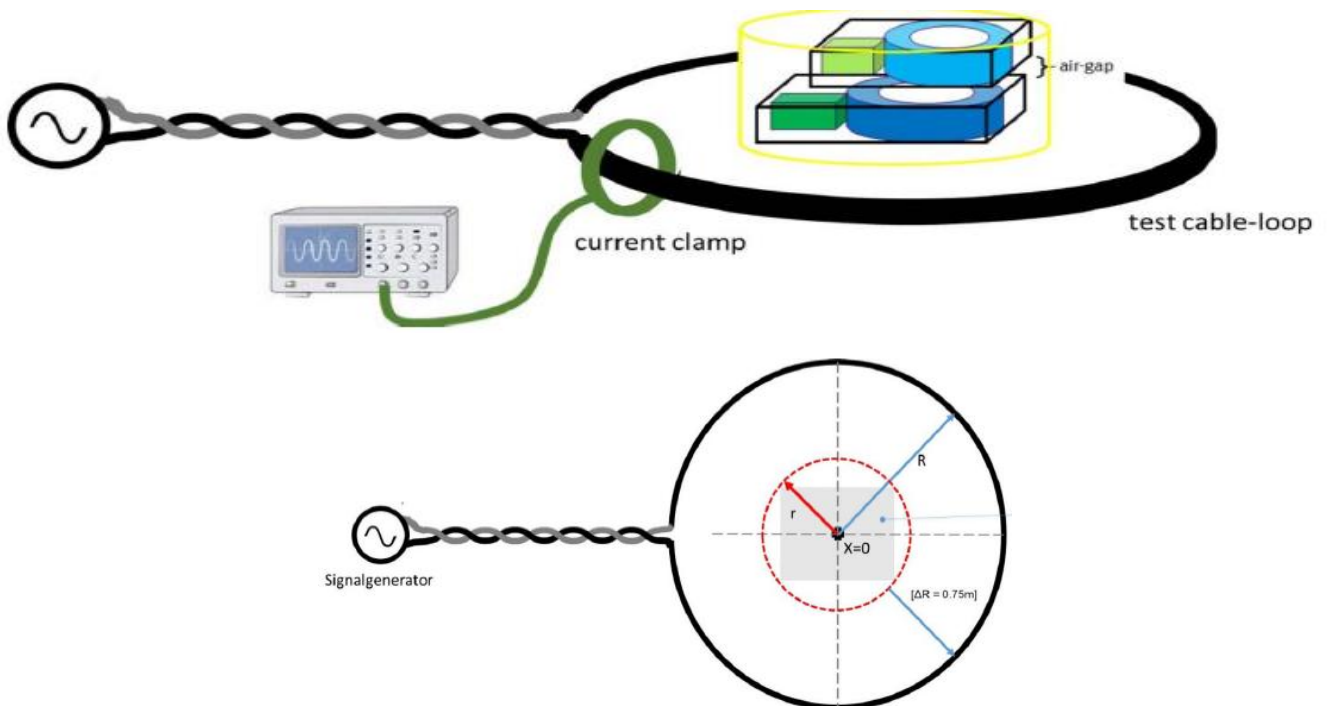

TEST PROCEDURE:

- 1). The test shall be carried out inside a test chamber according to clauses C.1.1 and C.1.2 in ETSI EN 300 330
- 2). A test loop with a radius r shall be used to create the magnetic field; the test loop shall lie on a non-metallic ground and the minimum distance to metallic objects (e.g. ground plane) shall be 0,75 m. The EUT shall be placed to the centre of the test-loop
- 3). The test loop shall be sufficiently large so that the test loop itself does not influence the WPT system; The radius R of the test-loop shall be in minimum $\Delta R = 0,75\text{ m}$ larger than the maximum dimension r of the EUT.

$$R \geq r + \Delta R.$$

The maximum H-Field can be calculated from the loop current I (into the test-loop) with the following formula:

$$H = I/2R$$

Any report having not been signed by authorized approver, or having been altered without authorization, or having not been stamped by the "Dedicated Testing/Inspection Stamp" is deemed to be invalid. Copying or excerpting portion of, or altering the content of the report is not permitted without the written authorization of AGC. The test results presented in the report apply only to the tested sample. Any objections to report issued by AGC should be submitted to AGC within 15 days after the issuance of the test report. Further enquiry of validity or verification of the test report should be addressed to AGC by agc01@agccert.com.

4)The required output current to achieve the required magnetic field at the WPT system shall be generated with a signal generator (unmodulated signal) at the test frequencies. For each test frequency the "reaction" of the device shall be recorded and checked against the performance criterion

LIMITS

The EUT shall achieve the wanted performance criterion, in the presence of the blocking signal.

Table 6: Receiver blocking limits

	In-band signal	OOB signal	Remote-band signal
Frequency	Centre frequency (f_c) of the WPT system (see clause 4.3.3)	$f = f_c \pm F$ (see note)	$f = f_c \pm 10 \times F$ (see note)
Signal level field strength at the EUT	72 dB μ A/m	72 dB μ A/m	82 dB μ A/m
NOTE: F = OFR see clause 4.3.3.			

TEST RESULT

Test Mode: Mode 1

Test Frequency(KHz)		Signal level @ EUT	Performance	Result
In-band signal	189.000	72dBuA/m	No function loss	Pass
OOB signal	188.518	72dBuA/m	No function loss	Pass
	189.482	72dBuA/m	No function loss	Pass
Remote-band signal	184.180	82dBuA/m	No function loss	Pass
	193.820	82dBuA/m	No function loss	Pass

Test Mode: Mode 3

Test Frequency(KHz)		Signal level @ EUT	Performance	Result
In-band signal	143.640	72dBuA/m	No function loss	Pass
OOB signal	142.662	72dBuA/m	No function loss	Pass
	144.618	72dBuA/m	No function loss	Pass
Remote-band signal	133.860	82dBuA/m	No function loss	Pass
	153.420	82dBuA/m	No function loss	Pass

Any report having not been signed by authorized approver, or having been altered without authorization, or having not been stamped by the "Dedicated Testing/Inspection Stamp" is deemed to be invalid. Copying or excerpting portion of, or altering the content of the report is not permitted without the written authorization of AGC. The test results presented in the report apply only to the tested sample. Any objections to report issued by AGC should be submitted to AGC within 15days after the issuance of the test report. Further enquiry of validity or verification of the test report should be addressed to AGC by agc01@agccert.com.

Attestation of Global Compliance(Shenzhen)Co., Ltd

Attestation of Global Compliance(Shenzhen)Std & Tech Co., Ltd

Tel: +86-755 2523 4088 E-mail: agc@agccert.com Web: http://www.agccert.com/

6. INTERPRETATION OF MEASUREMENT RESULTS

All the measurement equipments and accessories have been carefully selected to meet the maximum measurement uncertainty specified below:

RF Frequency	$\pm 1 \times 10^{-7}$
RF Power, Conducted	$\pm 0.75\text{dB}$
Maximum Frequency Deviation: _ Within 300Hz and 6KHz of Audio Frequency _ Within 6KHz and 25KHz of Audio Frequency	$\pm 5\%$ $\pm 3\text{dB}$
Adjacent channel power	$\pm 3\text{dB}$
Conducted Emission of Transmitter, Valid Up to 12.75GHz	$\pm 4\text{dB}$
Conducted Emissions of Receivers	$\pm 3\text{dB}$
Radiated Emission of Transmitter, Valid Up to 12.75GHz	$\pm 6\text{dB}$

P.S. Uncertainty figures are valid to confidence level of 95% calculated according to the methods described in the ETSI TR 100 028.

Any report having not been signed by authorized approver, or having been altered without authorization, or having not been stamped by the "Dedicated Testing/Inspection Stamp" is deemed to be invalid. Copying or excerpting portion of, or altering the content of the report is not permitted without the written authorization of AGC. The test results presented in the report apply only to the tested sample. Any objections to report issued by AGC should be submitted to AGC within 15days after the issuance of the test report. Further enquiry of validity or verification of the test report should be addressed to AGC by agc01@agccert.com.

Attestation of Global Compliance(Shenzhen)Co., Ltd

Attestation of Global Compliance(Shenzhen)Std & Tech Co., Ltd

Tel: +86-755 2523 4088 E-mail: agc@agccert.com Web: <http://www.agccert.com/>

APPENDIX A: PHOTOGRAPHS OF TEST SETUP

Any report having not been signed by authorized approver, or having been altered without authorization, or having not been stamped by the “Dedicated Testing/Inspection Stamp” is deemed to be invalid. Copying or excerpting portion of, or altering the content of the report is not permitted without the written authorization of AGC. The test results presented in the report apply only to the tested sample. Any objections to report issued by AGC should be submitted to AGC within 15days after the issuance of the test report. Further enquiry of validity or verification of the test report should be addressed to AGC by agc01@agccert.com.

APPENDIX B: PHOTOGRAPHS OF THE EUT

Refer to the Report No.: AGC05443231209AP01
----END OF REPORT---

Any report having not been signed by authorized approver, or having been altered without authorization, or having not been stamped by the “Dedicated Testing/Inspection Stamp” is deemed to be invalid. Copying or excerpting portion of, or altering the content of the report is not permitted without the written authorization of AGC. The test results presented in the report apply only to the tested sample. Any objections to report issued by AGC should be submitted to AGC within 15days after the issuance of the test report. Further enquiry of validity or verification of the test report should be addressed to AGC by agc01@agccert.com.

Attestation of Global Compliance(Shenzhen)Co., Ltd
Attestation of Global Compliance(Shenzhen)Std & Tech Co., Ltd
Tel: +86-755 2523 4088 E-mail: agc@agccert.com Web: <http://www.agccert.com/>



Conditions of Issuance of Test Reports

1. All samples and goods are accepted by the Attestation of Global Compliance (Shenzhen) Co., Ltd (the “Company”) solely for testing and reporting in accordance with the following terms and conditions. The company provides its services on the basis that such terms and conditions constitute express agreement between the company and any person, firm or company requesting its services (the “Clients”).
2. Any report issued by Company as a result of this application for testing services (the “Report”) shall be issued in confidence to the Clients and the Report will be strictly treated as such by the Company. It may not be reproduced either in its entirety or in part and it may not be used for advertising or other unauthorized purposes without the written consent of the Company. The Clients to whom the Report is issued may, however, show or send it, or a certified copy thereof prepared by the Company to its customer, supplier or other persons directly concerned. The Company will not, without the consent of the Clients, enter into any discussion or correspondence with any third party concerning the contents of the Report, unless required by the relevant governmental authorities, laws or court orders.
3. The Company shall not be called or be liable to be called to give evidence or testimony on the Report in a court of law without its prior written consent, unless required by the relevant governmental authorities, laws or court orders.
4. In the event of the improper use of the report as determined by the Company, the Company reserves the right to withdraw it, and to adopt any other additional remedies which may be appropriate.
5. Samples submitted for testing are accepted on the understanding that the Report issued cannot form the basis of, or be the instrument for, any legal action against the Company.
6. The Company will not be liable for or accept responsibility for any loss or damage however arising from the use of information contained in any of its Reports or in any communication whatsoever about its said tests or investigations.
7. Clients wishing to use the Report in court proceedings or arbitration shall inform the Company to that effect prior to submitting the sample for testing.
8. The Company is not responsible for recalling the electronic version of the original report when any revision is made to them. The Client assumes the responsibility to providing the revised version to any interested party who uses them.
9. Subject to the variable length of retention time for test data and report stored hereinto as otherwise specifically required by individual accreditation authorities, the Company will only keep the supporting test data and information of the test report for a period of six years. The data and information will be disposed of after the aforementioned retention period has elapsed. Under no circumstances shall we provide any data and information which has been disposed of after retention period. Under no circumstances shall we be liable for damage of any kind, including (but not limited to) compensatory damages, lost profits, lost data, or any form of special, incidental, indirect, consequential or punitive damages of any kind, whether based on breach of contract of warranty, tort (including negligence), product liability or otherwise, even if we are informed in advance of the possibility of such damages.

Any report having not been signed by authorized approver, or having been altered without authorization, or having not been stamped by the “Dedicated Testing/Inspection Stamp” is deemed to be invalid. Copying or excerpting portion of, or altering the content of the report is not permitted without the written authorization of AGC. The test results presented in the report apply only to the tested sample. Any objections to report issued by AGC should be submitted to AGC within 15days after the issuance of the test report. Further enquiry of validity or verification of the test report should be addressed to AGC by agc01@agccert.com.

Health Test Report

Report No.: AGC05443231209EH01

PRODUCT DESIGNATION : Magnetic wireless charger
BRAND NAME : N/A
MODEL NAME : MO6874
APPLICANT : MID OCEAN BRANDS B.V
DATE OF ISSUE : Dec. 14, 2023
STANDARD(S) : EN IEC 62311:2020
: EN 50665:2017
REPORT VERSION : V1.0

Attestation of Global Compliance (Shenzhen) Co., Ltd.



Any report having not been signed by authorized approver, or having been altered without authorization, or having not been stamped by the "Dedicated Testing/Inspection Stamp" is deemed to be invalid. Copying or excerpting portion of, or altering the content of the report is not permitted without the written authorization of AGC. The test results presented in the report apply only to the tested sample. Any objections to report issued by AGC should be submitted to AGC within 15days after the issuance of the test report. Further enquiry of validity or verification of the test report should be addressed to AGC by agc01@agccert.com.

Attestation of Global Compliance(Shenzhen)Co., Ltd
Attestation of Global Compliance(Shenzhen)Std & Tech Co., Ltd
Tel: +86-755 2523 4088 E-mail: agc@agccert.com Web: <http://www.agccert.com/>



REPORT REVISE RECORD

Report Version	Revise Time	Issued Date	Valid Version	Notes
V1.0	/	Dec. 14, 2023	Valid	Initial release

Any report having not been signed by authorized approver, or having been altered without authorization, or having not been stamped by the “Dedicated Testing/Inspection Stamp” is deemed to be invalid. Copying or excerpting portion of, or altering the content of the report is not permitted without the written authorization of AGC. The test results presented in the report apply only to the tested sample. Any objections to report issued by AGC should be submitted to AGC within 15days after the issuance of the test report. Further enquiry of validity or verification of the test report should be addressed to AGC by agc01@agccert.com.

TABLE OF CONTENTS

1. GENERAL INFORMATION	4
2. TECHNICAL INFORMATION	5
3. RF EXPOSURE MEASUREMENT	6
3.1 INTRODUCTION	6
3.2 TEST LIMIT	7
3.3 EVALUATION METHODS	8
4. TEST EQUIPMENT LIST	9
5. EUT OPERATION CONDITION	9
4. TEST RESULT	10
5. CONCLUSION	10

Any report having not been signed by authorized approver, or having been altered without authorization, or having not been stamped by the "Dedicated Testing/Inspection Stamp" is deemed to be invalid. Copying or excerpting portion of, or altering the content of the report is not permitted without the written authorization of AGC. The test results presented in the report apply only to the tested sample. Any objections to report issued by AGC should be submitted to AGC within 15days after the issuance of the test report. Further enquiry of validity or verification of the test report should be addressed to AGC by agc01@agccert.com.

1. GENERAL INFORMATION

Applicant	MID OCEAN BRANDS B.V
Address	Unit 201 2/F,. Laford Centre,838 Lai Chi Kok Road, Cheung Sha Wan, Kowloon, Hongkong
Manufacturer	MID OCEAN BRANDS B.V
Address	Unit 201 2/F,. Laford Centre,838 Lai Chi Kok Road, Cheung Sha Wan, Kowloon, Hongkong
Factory	N/A
Address	N/A
Product Designation	Magnetic wireless charger
Brand Name	N/A
Test Model	MO6874
Series Model(s)	N/A
Difference Description	N/A
Date of receipt of test item	Dec. 08, 2023
Date of test	Dec. 08, 2023 to Dec. 14, 2023
Test Result	Pass

Note: The test results of this report relate only to the tested sample identified in this report.

Prepared By *Thea Huang*

 Thea Huang
 (Project Engineer) Dec. 14, 2023

Reviewed By *Calvin Liu*

 Calvin Liu
 (Reviewer) Dec. 14, 2023

Approved By *Max Zhang*

 Max Zhang
 (Authorized Officer) Dec. 14, 2023

Any report having not been signed by authorized approver, or having been altered without authorization, or having not been stamped by the "Dedicated Testing/Inspection Stamp" is deemed to be invalid. Copying or excerpting portion of, or altering the content of the report is not permitted without the written authorization of AGC. The test results presented in the report apply only to the tested sample. Any objections to report issued by AGC should be submitted to AGC within 15days after the issuance of the test report. Further enquiry of validity or verification of the test report should be addressed to AGC by agc01@agccert.com.

2. TECHNICAL INFORMATION

Note: the following data is based on the information by the applicant.

Product Designation	Magnetic wireless charger
Brand Name	N/A
Test Model	MO6874
Hardware Version	V1.0
Software Version	V1.0
Frequency Band	110KHz-205KHz
Antenna Type	Coil Antenna
Wireless Charging Power	15 W Max.
Power Supply	Type C Input: DC5V 2.4A,9V 2A Type C Output: DC 5V 3A,9V 2.22A,12V 1.66A Wireless Output: DC5V 1A,7.5V 1A,9V 1.12A,9V 1.66A Capacity: 5000mAh/18.5Wh

Note: For more details, please refer to the user's manual of the EUT.

3. RF EXPOSURE MEASUREMENT

3.1 INTRODUCTION

This International Standard applies to electronic and electrical equipment for which no dedicated product- or product family standard regarding human exposure to electromagnetic fields applies.

This generic standard applies to electronic and electrical apparatus for which no dedicated product- or product family standard regarding human exposure to electromagnetic fields applies.

The frequency range covered is 0 Hz to 300 GHz.

The object of this generic standard is to provide assessment methods and criteria to evaluate such equipment against basic restrictions or reference levels on exposure of the general public related to electric, magnetic, electromagnetic fields and induced and contact current.

NOTE: This standard is intended to cover both intentional and non-intentional radiators. If the equipment complies with the requirements in another relevant standard, e.g. EN 62479 covering low power equipment, then the requirements of this standard (IEC 62311) are considered to be met and the application of this standard to that equipment is not necessary.

3.2 TEST LIMIT

According to EN IEC 62311:2020, Assessment of electronic and electrical equipment related to human exposure restrictions for electromagnetic fields (0 Hz – 300 GHz).

Annex F Measurement of E and H field

A commonly used probe size is 100 cm², also the contribution of the three axes X, Y and Z can be evaluated separately.

Reference levels for electric, magnetic and electromagnetic fields
(0 Hz to 300 GHz, unperturbed rms values)

Frequency range	E-field strength (V/m)	H-field strength (A/m)	B-field (μT)	Equivalent plane wave power density S_{eq} (W/m ²)
0-1 Hz	—	$3,2 \times 10^4$	4×10^4	—
1-8 Hz	10 000	$3,2 \times 10^4/f^2$	$4 \times 10^4/f^2$	—
8-25 Hz	10 000	$4\,000/f$	$5\,000/f$	—
0,025-0,8 kHz	$250/f$	$4/f$	$5/f$	—
0,8-3 kHz	$250/f$	5	6,25	—
3-150 kHz	87	5	6,25	—
0,15-1 MHz	87	$0,73/f$	$0,92/f$	—
1-10 MHz	$87/f^{1/2}$	$0,73/f$	$0,92/f$	—
10-400 MHz	28	0,073	0,092	2
400-2 000 MHz	$1,375 f^{1/2}$	$0,0037 f^{1/2}$	$0,0046 f^{1/2}$	$f/200$
2-300 GHz	61	0,16	0,20	10

Any report having not been signed by authorized approver, or having been altered without authorization, or having not been stamped by the “Dedicated Testing/Inspection Stamp” is deemed to be invalid. Copying or excerpting portion of, or altering the content of the report is not permitted without the written authorization of AGC. The test results presented in the report apply only to the tested sample. Any objections to report issued by AGC should be submitted to AGC within 15days after the issuance of the test report. Further enquiry of validity or verification of the test report should be addressed to AGC by agc01@agccert.com.

3.3 EVALUATION METHODS

Measurement of E and H field

A commonly used probe size is 100 cm², also the contribution of the three axes X, Y and Z can be evaluated separately.

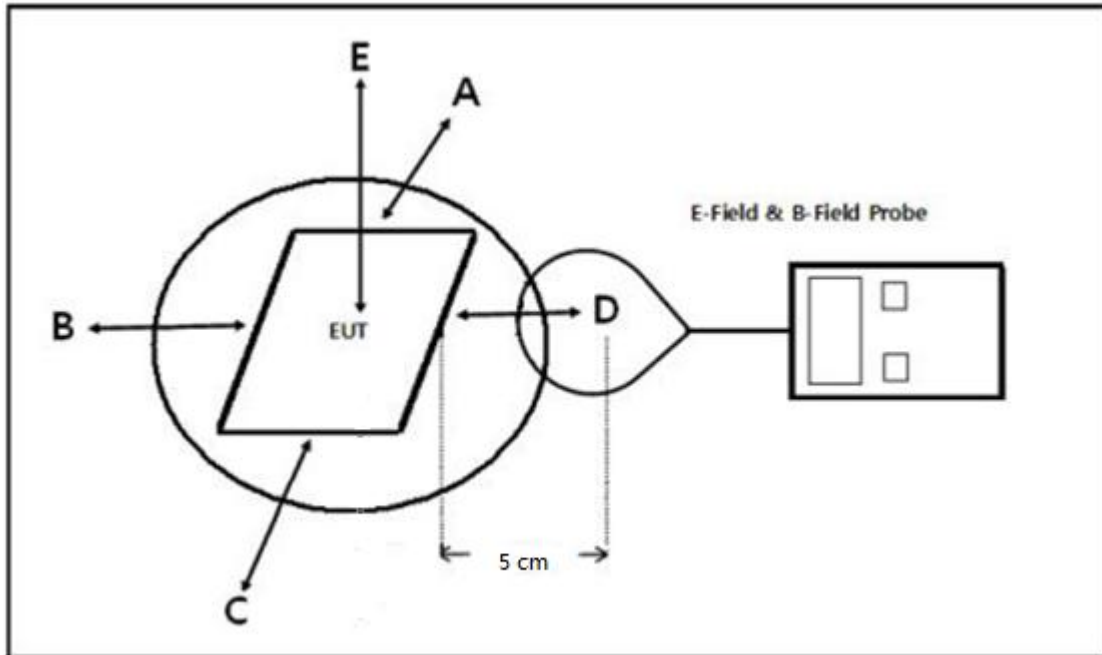

Note: Position A: Front of EUT; Position B: Left of EUT; Position C: back of EUT; Position D: Right of EUT; Position E: Top of EUT

Based on the above standard limit, any device with output power below 5A/m cannot produce an exposure exceeding this restriction under the most pessimistic exposure conditions.

Any report having not been signed by authorized approver, or having been altered without authorization, or having not been stamped by the "Dedicated Testing/Inspection Stamp" is deemed to be invalid. Copying or excerpting portion of, or altering the content of the report is not permitted without the written authorization of AGC. The test results presented in the report apply only to the tested sample. Any objections to report issued by AGC should be submitted to AGC within 15days after the issuance of the test report. Further enquiry of validity or verification of the test report should be addressed to AGC by agc01@agccert.com.

4. TEST EQUIPMENT LIST

Description	Manufacturer	Model	S/N	Cal. Date	Cal. Due
Broadband Field Meter	WAVECONTROL	SMP2	19SN1101	Feb. 24, 2023	Feb. 23, 2025
Probe FHP	WAVECONTROL	WP400	19WP100558	Feb. 24, 2023	Feb. 23, 2025

5. EUT OPERATION CONDITION

NO.	TEST MODE DESCRIPTION
1	Adapter(9V/2A) + EUT + Wireless load(Full load)
2	Adapter(9V/2A) + EUT + Wireless load(half load)
3	Adapter(9V/2A) + EUT + Wireless load(null load)
4	Adapter(5V/2.4A) + EUT + Wireless load(Full load)
5	EUT +Wireless load(Full load)
6	EUT +Wireless load(half load)
7	EUT +Wireless load(null load)

Note: 1. V means EMI worst mode.
2. All modes have been tested and only the worst mode test data recorded in the test report.

Any report having not been signed by authorized approver, or having been altered without authorization, or having not been stamped by the "Dedicated Testing/Inspection Stamp" is deemed to be invalid. Copying or excerpting portion of, or altering the content of the report is not permitted without the written authorization of AGC. The test results presented in the report apply only to the tested sample. Any objections to report issued by AGC should be submitted to AGC within 15days after the issuance of the test report. Further enquiry of validity or verification of the test report should be addressed to AGC by agc01@agccert.com.

4. TEST RESULT

Frequency	Maximum Radiated H-Field at 5cm		Limit	Result
MHz	A/m		A/m	Pass/Fail
110KHz-205KHz	position E	0.079	5	Pass
	position A	0.063		
	position B	0.045		
	position C	0.052		
	position D	0.081		

Since Radiated H-Field at worse case is 0.081A/m which cannot exceed the exempt condition, 5A/m. It is deemed to full fit the requirement of RF exposure basic restrisction specified in EC Council Recommendation (1999/519/EC).

5. CONCLUSION

Remark: EUT meets the basic requirements in the standard.

APPENDIX I: PHOTOGRAPHS OF TEST SETUP

WPT Equipment_ Position E

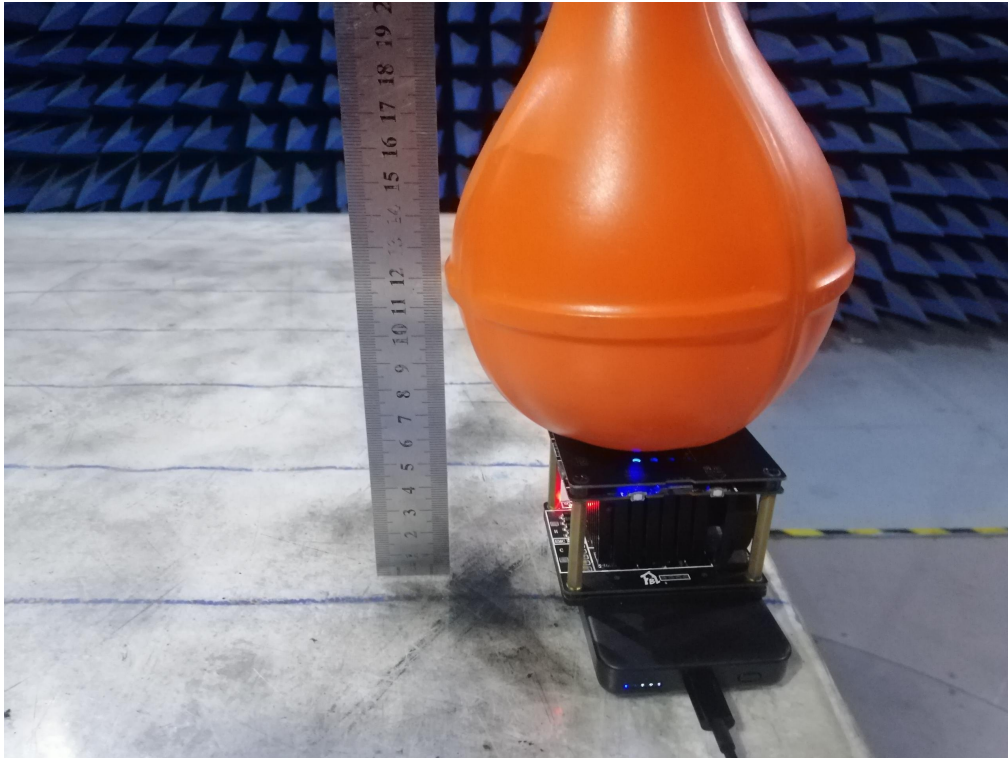

WPT Equipment_ Position A



Any report having not been signed by authorized approver, or having been altered without authorization, or having not been stamped by the “Dedicated Testing/Inspection Stamp” is deemed to be invalid. Copying or excerpting portion of, or altering the content of the report is not permitted without the written authorization of AGC. The test results presented in the report apply only to the tested sample. Any objections to report issued by AGC should be submitted to AGC within 15days after the issuance of the test report. Further enquiry of validity or verification of the test report should be addressed to AGC by agc01@agccert.com.

WPT Equipment_ Position B



WPT Equipment_ Position C

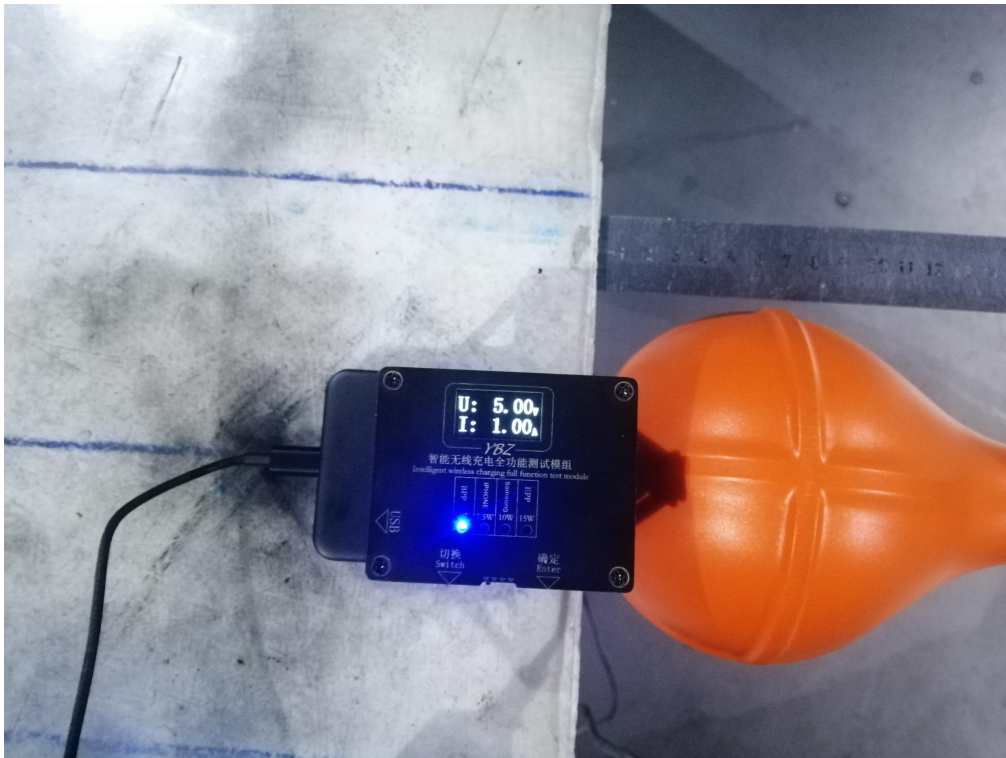

Any report having not been signed by authorized approver, or having been altered without authorization, or having not been stamped by the “Dedicated Testing/Inspection Stamp” is deemed to be invalid. Copying or excerpting portion of, or altering the content of the report is not permitted without the written authorization of AGC. The test results presented in the report apply only to the tested sample. Any objections to report issued by AGC should be submitted to AGC within 15days after the issuance of the test report. Further enquiry of validity or verification of the test report should be addressed to AGC by agc01@agccert.com.

WPT Equipment_ Position D



----END OF REPORT----

Any report having not been signed by authorized approver, or having been altered without authorization, or having not been stamped by the “Dedicated Testing/Inspection Stamp” is deemed to be invalid. Copying or excerpting portion of, or altering the content of the report is not permitted without the written authorization of AGC. The test results presented in the report apply only to the tested sample. Any objections to report issued by AGC should be submitted to AGC within 15days after the issuance of the test report. Further enquiry of validity or verification of the test report should be addressed to AGC by agc01@agccert.com.



Conditions of Issuance of Test Reports

1. All samples and goods are accepted by the Attestation of Global Compliance (Shenzhen) Co., Ltd (the “Company”) solely for testing and reporting in accordance with the following terms and conditions. The company provides its services on the basis that such terms and conditions constitute express agreement between the company and any person, firm or company requesting its services (the “Clients”).
2. Any report issued by Company as a result of this application for testing services (the “Report”) shall be issued in confidence to the Clients and the Report will be strictly treated as such by the Company. It may not be reproduced either in its entirety or in part and it may not be used for advertising or other unauthorized purposes without the written consent of the Company. The Clients to whom the Report is issued may, however, show or send it, or a certified copy thereof prepared by the Company to its customer, supplier or other persons directly concerned. The Company will not, without the consent of the Clients, enter into any discussion or correspondence with any third party concerning the contents of the Report, unless required by the relevant governmental authorities, laws or court orders.
3. The Company shall not be called or be liable to be called to give evidence or testimony on the Report in a court of law without its prior written consent, unless required by the relevant governmental authorities, laws or court orders.
4. In the event of the improper use of the report as determined by the Company, the Company reserves the right to withdraw it, and to adopt any other additional remedies which may be appropriate.
5. Samples submitted for testing are accepted on the understanding that the Report issued cannot form the basis of, or be the instrument for, any legal action against the Company.
6. The Company will not be liable for or accept responsibility for any loss or damage however arising from the use of information contained in any of its Reports or in any communication whatsoever about its said tests or investigations.
7. Clients wishing to use the Report in court proceedings or arbitration shall inform the Company to that effect prior to submitting the sample for testing.
8. The Company is not responsible for recalling the electronic version of the original report when any revision is made to them. The Client assumes the responsibility to providing the revised version to any interested party who uses them.
9. Subject to the variable length of retention time for test data and report stored hereinto as otherwise specifically required by individual accreditation authorities, the Company will only keep the supporting test data and information of the test report for a period of six years. The data and information will be disposed of after the aforementioned retention period has elapsed. Under no circumstances shall we provide any data and information which has been disposed of after retention period. Under no circumstances shall we be liable for damage of any kind, including (but not limited to) compensatory damages, lost profits, lost data, or any form of special, incidental, indirect, consequential or punitive damages of any kind, whether based on breach of contract of warranty, tort (including negligence), product liability or otherwise, even if we are informed in advance of the possibility of such damages.

Any report having not been signed by authorized approver, or having been altered without authorization, or having not been stamped by the “Dedicated Testing/Inspection Stamp” is deemed to be invalid. Copying or excerpting portion of, or altering the content of the report is not permitted without the written authorization of AGC. The test results presented in the report apply only to the tested sample. Any objections to report issued by AGC should be submitted to AGC within 15days after the issuance of the test report. Further enquiry of validity or verification of the test report should be addressed to AGC by agc01@agccert.com.