

---

# RF Test Report

---

Report No.: AGC05443240102ER02A

**PRODUCT DESIGNATION** : Magnetic Wireless charger  
**BRAND NAME** : N/A  
**MODEL NAME** : M06253  
**APPLICANT** : MID OCEAN BRANDS B.V  
**DATE OF ISSUE** : Jun. 18, 2024  
**STANDARD(S)** : ETSI EN 303 417 V1.1.1(2017-09)  
**REPORT VERSION** : V1.0



Attestation of Global Compliance (Shenzhen) Co., Ltd.

Any report having not been signed by authorized approver, or having been altered without authorization, or having not been stamped by the "Dedicated Testing/Inspection Stamp" is deemed to be invalid. Copying or excerpting portion of, or altering the content of the report is not permitted without the written authorization of AGC. The test results presented in the report apply only to the tested sample. Any objections to report issued by AGC should be submitted to AGC within 15days after the issuance of the test report. Further enquiry of validity or verification of the test report should be addressed to AGC by agc01@agccert.com.

Attestation of Global Compliance(Shenzhen)Co., Ltd  
Attestation of Global Compliance(Shenzhen)Std & Tech Co., Ltd  
Tel: +86-755 2523 4088 E-mail: agc@agccert.com Web: <http://www.agccert.com/>



### REPORT REVISE RECORD

Report Version	Revise Time	Issued Date	Valid Version	Notes
V1.0	/	Jun. 18, 2024	Valid	Initial Release

Note: The original test report AGC05443240102ER02 (dated Jan. 30, 2024 and tested from Jan. 04, 2024 to Jan. 30, 2024) was modified on Jun. 18, 2024, including the following changes and additions:

- Changed the Test Model Name.
- Changed the shell material and photo of the EUT.

For the above described changes, no further testing is necessary.

Any report having not been signed by authorized approver, or having been altered without authorization, or having not been stamped by the "Dedicated Testing/Inspection Stamp" is deemed to be invalid. Copying or excerpting portion of, or altering the content of the report is not permitted without the written authorization of AGC. The test results presented in the report apply only to the tested sample. Any objections to report issued by AGC should be submitted to AGC within 15days after the issuance of the test report. Further enquiry of validity or verification of the test report should be addressed to AGC by [agc01@agccert.com](mailto:agc01@agccert.com).

Attestation of Global Compliance(Shenzhen)Co., Ltd  
Attestation of Global Compliance(Shenzhen)Std & Tech Co., Ltd  
Tel: +86-755 2523 4088 E-mail: [agc@agccert.com](mailto:agc@agccert.com) Web: <http://www.agccert.com/>

## TABLE OF CONTENTS

<b>1. TEST RESULT CERTIFICATION .....</b>	<b>4</b>
<b>2. EUT DESCRIPTION .....</b>	<b>5</b>
<b>3. DESCRIPTION OF TEST ITEMS .....</b>	<b>6</b>
<b>4. TEST FACILITY .....</b>	<b>6</b>
<b>5. ETSI EN 303 417 REQUIREMENT .....</b>	<b>7</b>
5.1 TRANSMITTER H-FIELD REQUIREMENTS .....	7
5.2 OPERATING FREQUENCY RANGES .....	12
5.3 TRANSMITTER OUT OF BAND (OOB) EMISSIONS .....	15
5.4 TRANSMITTER SPURIOUS EMISSIONS .....	18
5.5 RECEIVER BLOCKING .....	27
<b>6. INTERPRETATION OF MEASUREMENT RESULTS .....</b>	<b>29</b>
<b>APPENDIX A: PHOTOGRAPHS OF TEST SETUP .....</b>	<b>30</b>
<b>APPENDIX B: PHOTOGRAPHS OF THE EUT .....</b>	<b>31</b>

Any report having not been signed by authorized approver, or having been altered without authorization, or having not been stamped by the “Dedicated Testing/Inspection Stamp” is deemed to be invalid. Copying or excerpting portion of, or altering the content of the report is not permitted without the written authorization of AGC. The test results presented in the report apply only to the tested sample. Any objections to report issued by AGC should be submitted to AGC within 15days after the issuance of the test report. Further enquiry of validity or verification of the test report should be addressed to AGC by agc01@agccert.com.

### 1. TEST RESULT CERTIFICATION

Applicant	MID OCEAN BRANDS B.V
Address	Unit 201 2/F,. Laford Centre, 838 Lai Chi Kok Road, Cheung Sha Wan, Kowloon, Hongkong
Manufacturer	MID OCEAN BRANDS B.V
Address	Unit 201 2/F,. Laford Centre, 838 Lai Chi Kok Road, Cheung Sha Wan, Kowloon, Hongkong
Factory	MID OCEAN BRANDS B.V
Address	Unit 201 2/F,. Laford Centre, 838 Lai Chi Kok Road, Cheung Sha Wan, Kowloon, Hongkong
Product Designation	Magnetic Wireless charger
Brand Name	N/A
Test Model	MO6253
Series Model	N/A
Difference description	N/A
Date of receipt of test	May 17, 2024
Date of test	N/A
Deviation	None
Condition of Test Sample	Normal
Test Result	Pass
Report Template	AGCRT-EC-WPT-RF

The above equipment was tested by SHENZHEN ATTESTATION OF GLOBAL COMPLIANCE (SHENZHEN) CO., LTD. for compliance with the requirements set forth in the European Standard ETSI EN 303 417 V1.1.1. The results of testing in this report apply to the product/system which was tested only. Other similar equipment will not necessarily produce the same results due to production tolerance and measurement uncertainties.

Prepared By



Cici Li  
(Project Engineer)

Jun. 18, 2024

Reviewed By



Calvin Liu  
(Reviewer)

Jun. 18, 2024

Approved By



Max Zhang  
(Authorized Officer)

Jun. 18, 2024

Any report having not been signed by authorized approver, or having been altered without authorization, or having not been stamped by the “Dedicated Testing/Inspection Stamp” is deemed to be invalid. Copying or excerpting portion of, or altering the content of the report is not permitted without the written authorization of AGC. The test results presented in the report apply only to the tested sample. Any objections to report issued by AGC should be submitted to AGC within 15days after the issuance of the test report. Further enquiry of validity or verification of the test report should be addressed to AGC by agc01@agccert.com.

## 2. EUT DESCRIPTION

Details of technical specification refer to the description in follows:

Hardware Version	V1.0
Software Version	V1.0
Operate Frequency	110kHz-205kHz
Modulation Type	ASK
OCW	Energy transmission: Low channel 0.968kHz, Middle Channel 0.966kHz, High channel 0.966kHz Data communication: 0.827kHz
Test Channels	Energy transmission: Low channel 136.41kHz, Middle Channel 138.99kHz, High channel 138.76kHz Data communication: 132.8kHz
Antenna Type	Coil Antenna
Operational Mode	Mode 1: base station in stand-by, idle mode Mode 3: communication Mode 4: energy transmission
EUT Input Rating	DC 9V 1.5A / DC 5V 2A
EUT Output Rating	DC 9V 1.1A / DC 5V 1A

**NOTE:** 1. For more information, please refer to User's Manual.

2. During the initial establishment of the charging mode (mode 2), no or very low emission occur (below the sensitivity level of the test set-up), so the mode 2 can be assumed as irrelevant for the test.

3. Mode 3 and mode 4 have been performed within one set-up, worst-case alignment. But each mode have been tested separately with specific test software.

4. The maximum temperature of 40 is not a standard requirement and is measured according to the maximum service temperature stated by the manufacturer.

### 3. DESCRIPTION OF TEST ITEMS

Harmonised Standard ETSI EN 303 417		
Requirement		Requirement Conditionality
No	Description	
1	Permitted range of operating frequencies	<input checked="" type="checkbox"/> Applicable <input type="checkbox"/> Not Applicable
2	Operating frequency ranges	<input checked="" type="checkbox"/> Applicable <input type="checkbox"/> Not Applicable
3	H-field requirements	<input checked="" type="checkbox"/> Applicable <input type="checkbox"/> Not Applicable
4	Transmitter spurious emissions	<input checked="" type="checkbox"/> Applicable <input type="checkbox"/> Not Applicable
5	Transmitter out of band (OOB) emissions	<input checked="" type="checkbox"/> Applicable <input type="checkbox"/> Not Applicable
6	WPT system unwanted conducted emissions	<input type="checkbox"/> Applicable <input checked="" type="checkbox"/> Not Applicable
7	Receiver blocking	<input checked="" type="checkbox"/> Applicable <input type="checkbox"/> Not Applicable

### 4. TEST FACILITY

<b>Test Site</b>	Attestation of Global Compliance (Shenzhen) Co., Ltd
<b>Location</b>	1-2/F, Building 19, Junfeng Industrial Park, Chongqing Road, Heping Community, Fuhai Street, Bao'an District, Shenzhen, Guangdong, China

Any report having not been signed by authorized approver, or having been altered without authorization, or having not been stamped by the "Dedicated Testing/Inspection Stamp" is deemed to be invalid. Copying or excerpting portion of, or altering the content of the report is not permitted without the written authorization of AGC. The test results presented in the report apply only to the tested sample. Any objections to report issued by AGC should be submitted to AGC within 15days after the issuance of the test report. Further enquiry of validity or verification of the test report should be addressed to AGC by agc01@agccert.com.

Attestation of Global Compliance(Shenzhen)Co., Ltd

Attestation of Global Compliance(Shenzhen)Std & Tech Co., Ltd

Tel: +86-755 2523 4088 E-mail: agc@agccert.com Web: http://www.agccert.com/

## 5. ETSI EN 303 417 REQUIREMENT

### 5.1 TRANSMITTER H-FIELD REQUIREMENTS

#### MEASUREMENT EQUIPMENT USED:

NAME OF EQUIPMENT	MANUFACTURER	MODEL	S/N	Cal. Date	Cal. Due
Test Receiver	R&S	ESCI	10096	Feb. 18, 2023	Feb. 17, 2024
Power amplifier	AR	75A250	18464	N/A	N/A
Active loop antenna(9K-30MHz)	ZHINAN	ZN30900C	18051	Mar. 12, 2022	Mar. 11, 2024

#### TEST SETUP:

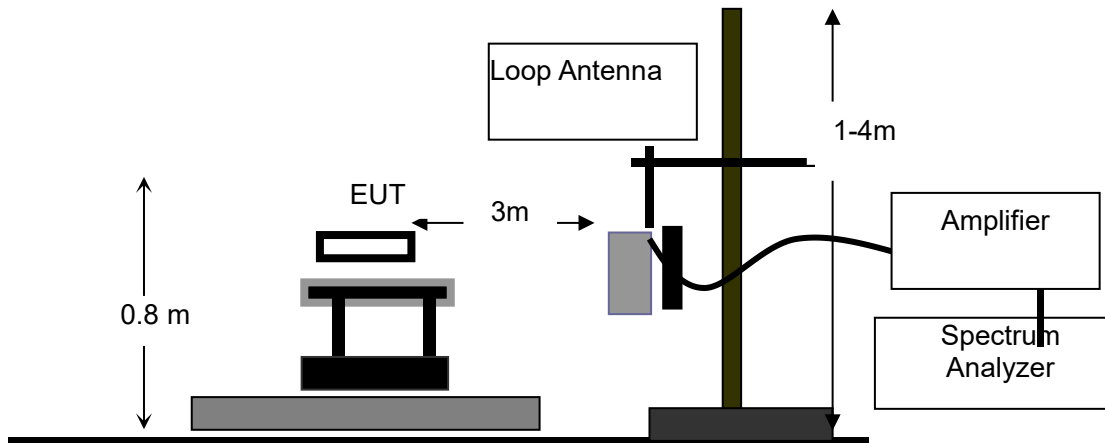

Any report having not been signed by authorized approver, or having been altered without authorization, or having not been stamped by the "Dedicated Testing/Inspection Stamp" is deemed to be invalid. Copying or excerpting portion of, or altering the content of the report is not permitted without the written authorization of AGC. The test results presented in the report apply only to the tested sample. Any objections to report issued by AGC should be submitted to AGC within 15days after the issuance of the test report. Further enquiry of validity or verification of the test report should be addressed to AGC by agc01@agccert.com.

**TEST LIMITS:**

The H-field limit in dBµA/m at 3 m,  $H_{3m}$ , is determined by the following equation:

$$H_{3m} = H_{10m} + C_3 \quad (F.2)$$

Where:  $H_{10m}$  is the H-field limit in dBµA/m at 10 m distance according to the present document; and  $C_3$  is a conversion factor in dB determined from figure F.2.

According to EN 303 417 Tablet 3,

**Table 3: H-field limits**

Frequency range [MHz]	H-field strength limit [dBµA/m at 10 m]	Comments
$0,019 \leq f < 0,021$	72	
$0,059 \leq f < 0,061$	69,1 descending 10 dB/dec above 0,059 MHz	See note 1
$0,079 \leq f < 0,090$	67,8 descending 10 dB/dec above 0,079 MHz	See note 2
$0,100 \leq f < 0,119$	42	
$0,119 \leq f < 0,135$	66 descending 10 dB/dec above 0,119 MHz	See note 1
$0,135 \leq f < 0,140$	42	
$0,140 \leq f < 0,1485$	37,7	
$0,1485 \leq f < 0,30$	-5	
$6,765 \leq f < 6,795$	42	

NOTE 1: Limit is 42 dBµA/m for the following spot frequencies: 60 kHz ± 250 Hz and 129,1 kHz ± 500 Hz.  
NOTE 2: At the time of preparation of the present document the feasibility of increased limits for high power wireless power transmission systems to charge vehicles [1.4] was prepared. New specific requirements for such systems (e.g. higher H-field emission limits in the 79 - 90 kHz band) will be reflected within a future revision of the present document.

Correction factor,  $C_3$ , for limits at 3 m distance, dB

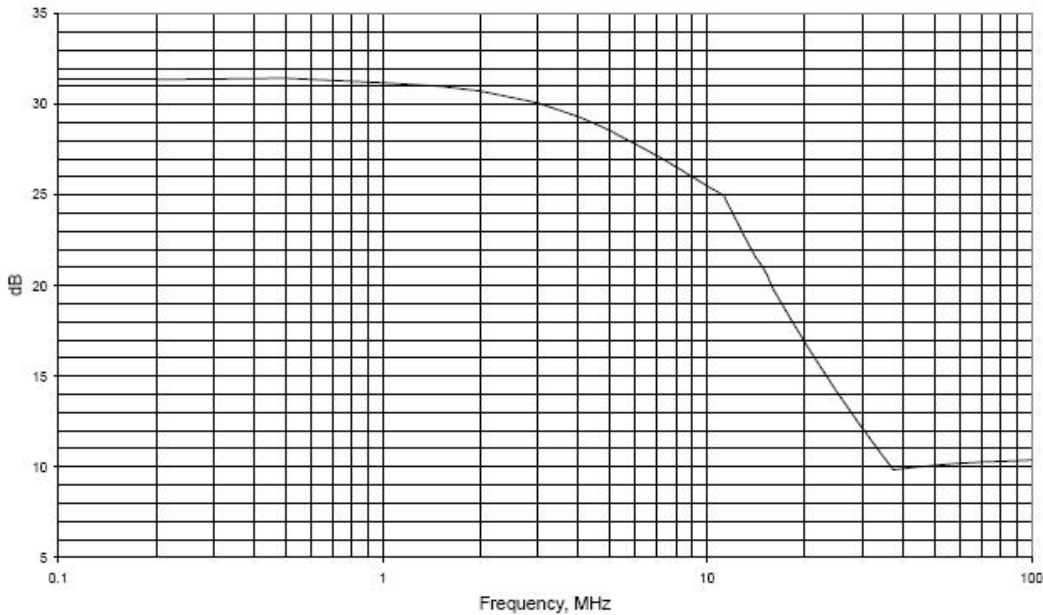

**Figure F.2: Conversion factor  $C_3$  versus frequency**

Any report having not been signed by authorized approver, or having been altered without authorization, or having not been stamped by the "Dedicated Testing/Inspection Stamp" is deemed to be invalid. Copying or excerpting portion of, or altering the content of the report is not permitted without the written authorization of AGC. The test results presented in the report apply only to the tested sample. Any objections to report issued by AGC should be submitted to AGC within 15days after the issuance of the test report. Further enquiry of validity or verification of the test report should be addressed to AGC by agc01@agccert.com.



**TEST PROCEDURE:**

The EUT was placed on the top of an insulating table 0.8 meters above the ground at a semi-anechoic chamber. The table was rotated 360 degrees to determine the position of the highest radiation.

The EUT was set 3 meters away from the interference-receiving antenna, which was mounted on the top of a variable-height antenna tower.

The H-field is measured with a shielded loop antenna connected to a measurement receiver.

The measuring bandwidth and detector type of the measurement receiver shall be in accordance with EN 300 330 V2.1.1 Table 11.

The EUT operate with modulation under normal and extreme conditions.

**TEST RESULTS:**

Test Mode: Mode 1

Extreme conditions state

conditions	Test Temp	Test Volt.(V)	Note
TN/VN	25°C	9.0	Worst case
TL/VL	-10°C	8.1	
TH/VL	45°C	8.1	
TL/VH	-10°C	9.9	
TH/VH	45°C	9.9	

Test results tested at 3m test sites:

Freq.	Antenna Factor	Reading Level	Corrected Level	Limit
(MHz)	(dB/m)	(dBuA)	(dBuA/m)	(dBuA/m)
0.1387	23.53	-3.65	19.88	73.20

Test results calculated to 10m test sites:

Freq.	Antenna Factor	Reading Level	Corrected Level	Limit
(MHz)	(dB/m)	(dBuA)	(dBuA/m)	(dBuA/m)
0.1387	23.53	-34.85	-11.32	42.00

Any report having not been signed by authorized approver, or having been altered without authorization, or having not been stamped by the "Dedicated Testing/Inspection Stamp" is deemed to be invalid. Copying or excerpting portion of, or altering the content of the report is not permitted without the written authorization of AGC. The test results presented in the report apply only to the tested sample. Any objections to report issued by AGC should be submitted to AGC within 15days after the issuance of the test report. Further enquiry of validity or verification of the test report should be addressed to AGC by agc01@agccert.com.

Test Mode: Mode 3

## Extreme conditions state

conditions	Test Temp	Test Volt.(V)	Note
TN/VN	25°C	9.0	Worst case
TL/VL	-10°C	8.1	
TH/VL	45°C	8.1	
TL/VH	-10°C	9.9	
TH/VH	45°C	9.9	

## Test results tested at 3m test sites:

Freq.	Antenna Factor	Reading Level	Corrected Level	Limit
(MHz)	(dB/m)	(dBuA)	(dBuA/m)	(dBuA/m)
0.1328	23.53	3.68	27.21	62.40

## Test results calculated to 10m test sites:

Freq.	Antenna Factor	Reading Level	Corrected Level	Limit
(MHz)	(dB/m)	(dBuA)	(dBuA/m)	(dBuA/m)
0.1328	23.53	-19.87	3.66	31.20

Any report having not been signed by authorized approver, or having been altered without authorization, or having not been stamped by the "Dedicated Testing/Inspection Stamp" is deemed to be invalid. Copying or excerpting portion of, or altering the content of the report is not permitted without the written authorization of AGC. The test results presented in the report apply only to the tested sample. Any objections to report issued by AGC should be submitted to AGC within 15days after the issuance of the test report. Further enquiry of validity or verification of the test report should be addressed to AGC by agc01@agccert.com.

Attestation of Global Compliance(Shenzhen)Co., Ltd

Attestation of Global Compliance(Shenzhen)Std &amp; Tech Co., Ltd

Tel: +86-755 2523 4088 E-mail: agc@agccert.com Web: http://www.agccert.com/

Test Mode: Mode 4

## Extreme conditions state

conditions	Test Temp	Test Volt.(V)	Note
TN/VN	25°C	9.0	Worst case
TL/VL	-10°C	8.1	
TH/VL	45°C	8.1	
TL/VH	-10°C	9.9	
TH/VH	45°C	9.9	

## Test results tested at 3m test sites:

Freq.	Antenna Factor	Reading Level	Corrected Level	Limit
(MHz)	(dB/m)	(dBuA)	(dBuA/m)	(dBuA/m)
0.13641	23.53	3.29	26.82	73.20
0.13899	23.53	-6.89	16.64	73.20
0.13876	23.53	-7.88	15.65	73.20

## Test results calculated to 10m test sites:

Freq.	Antenna Factor	Reading Level	Corrected Level	Limit
(MHz)	(dB/m)	(dBuA)	(dBuA/m)	(dBuA/m)
0.13641	23.53	-27.91	-4.38	42.00
0.13899	23.53	-38.09	-14.56	42.00
0.13876	23.53	-39.08	-15.55	42.00

## Remark:

- (1) Corrected Level (dBuA/m) = Reading Level + Antenna Factor
- (2) For the calculated method, please refer to Annex F at EN 300330.
- (3) All extreme conditions were considered for test, but only record the worst case.

Any report having not been signed by authorized approver, or having been altered without authorization, or having not been stamped by the "Dedicated Testing/Inspection Stamp" is deemed to be invalid. Copying or excerpting portion of, or altering the content of the report is not permitted without the written authorization of AGC. The test results presented in the report apply only to the tested sample. Any objections to report issued by AGC should be submitted to AGC within 15days after the issuance of the test report. Further enquiry of validity or verification of the test report should be addressed to AGC by agc01@agccert.com.

Attestation of Global Compliance(Shenzhen)Co., Ltd

Attestation of Global Compliance(Shenzhen)Std &amp; Tech Co., Ltd

Tel: +86-755 2523 4088 E-mail: agc@agccert.com Web: http://www.agccert.com/

## 5.2 OPERATING FREQUENCY RANGES

### MEASUREMENT EQUIPMENT USED:

NAME OF EQUIPMENT	MANUFACTURER	MODEL	S/N	Cal. Date	Cal. Due
Test Receiver	R&S	ESCI	10096	Feb. 18, 2023	Feb. 17, 2024
Power amplifier	AR	75A250	18464	N/A	N/A
Active loop antenna(9K-30MHz)	ZHINAN	ZN30900C	18051	Mar. 12, 2022	Mar. 11, 2024

### TEST SETUP:

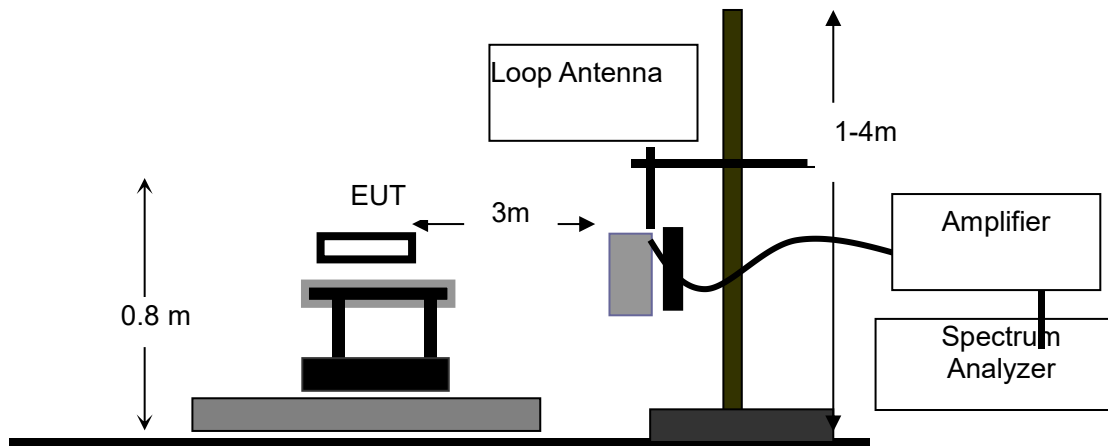

### TEST PROCEDURE:

- 1). The EUT was placed on a turn table which is 0.8m above ground plane.
- 2). The EUT was modulated by normal signal,
- 3). Set SPA Center Frequency = fundamental frequency, RBW=VBW=200Hz, Span=5kHz, Detector=RMS. The 99 % OBW function shall be used to determine the operating frequency range, fH is the frequency of the upper marker resulting from the OFR, fL is the frequency of the lower marker resulting from the OFR.
- 4). Both normal test condition and extreme test condition applied

### LIMITS

The operating frequency range for emissions shall be within one of the following limits: 19 - 21 kHz, 59 - 61 kHz, 79 - 90 kHz, 100 - 300 kHz, 6 765 - 6 795 kHz.

Any report having not been signed by authorized approver, or having been altered without authorization, or having not been stamped by the "Dedicated Testing/Inspection Stamp" is deemed to be invalid. Copying or excerpting portion of, or altering the content of the report is not permitted without the written authorization of AGC. The test results presented in the report apply only to the tested sample. Any objections to report issued by AGC should be submitted to AGC within 15days after the issuance of the test report. Further enquiry of validity or verification of the test report should be addressed to AGC by agc01@agccert.com.

**TEST RESULT**

Test Mode: Mode 1

## Frequency Range Test Result

Test Temperature	Test Voltage (V DC)	Lowest Frequency(K Hz)	Highest Frequency (KHz)	Limit
-10°C	9.9	138.284	139.118	100kHz≤&≤300kHz
	8.1	138.284	139.116	100kHz≤&≤300kHz
25°C	9.0	138.282	139.118	100kHz≤&≤300kHz
45°C	9.9	138.284	139.113	100kHz≤&≤300kHz
	8.1	138.286	139.116	100kHz≤&≤300kHz
OFR		0.836kHz		
Results		PASS		

Test Mode: Mode 3

## Frequency Range Test Result

Test Temperature	Test Voltage (V DC)	Lowest Frequency(K Hz)	Highest Frequency (KHz)	Limit
-10°C	9.9	132.390	133.212	100kHz≤&≤300kHz
	8.1	132.387	133.210	100kHz≤&≤300kHz
25°C	9.0	132.387	133.214	100kHz≤&≤300kHz
45°C	9.9	132.390	133.211	100kHz≤&≤300kHz
	8.1	132.389	133.210	100kHz≤&≤300kHz
OFR		0.827kHz		
Results		PASS		

Any report having not been signed by authorized approver, or having been altered without authorization, or having not been stamped by the "Dedicated Testing/Inspection Stamp" is deemed to be invalid. Copying or excerpting portion of, or altering the content of the report is not permitted without the written authorization of AGC. The test results presented in the report apply only to the tested sample. Any objections to report issued by AGC should be submitted to AGC within 15days after the issuance of the test report. Further enquiry of validity or verification of the test report should be addressed to AGC by agc01@agccert.com.

Attestation of Global Compliance(Shenzhen)Co., Ltd

Attestation of Global Compliance(Shenzhen)Std &amp; Tech Co., Ltd

Tel: +86-755 2523 4088 E-mail: agc@agccert.com Web: http://www.agccert.com/

Test Mode: Mode 4

## Frequency Range Test Result

Test Temperature	Test Voltage (V DC)	Lowest Frequency(K Hz)	Highest Frequency (KHz)	Limit
-10°C	9.9	135.927	139.243	100kHz≤&≤300kHz
	8.1	135.927	139.241	100kHz≤&≤300kHz
25°C	9.0	135.926	139.243	100kHz≤&≤300kHz
45°C	9.9	135.930	139.241	100kHz≤&≤300kHz
	8.1	135.931	139.240	100kHz≤&≤300kHz
OFR		3.317kHz		
Results		PASS		

**NOTE:** All the modes had been tested, but only the worst data recorded in the report.

Any report having not been signed by authorized approver, or having been altered without authorization, or having not been stamped by the "Dedicated Testing/Inspection Stamp" is deemed to be invalid. Copying or excerpting portion of, or altering the content of the report is not permitted without the written authorization of AGC. The test results presented in the report apply only to the tested sample. Any objections to report issued by AGC should be submitted to AGC within 15days after the issuance of the test report. Further enquiry of validity or verification of the test report should be addressed to AGC by agc01@agccert.com.

Attestation of Global Compliance(Shenzhen)Co., Ltd

Attestation of Global Compliance(Shenzhen)Std &amp; Tech Co., Ltd

Tel: +86-755 2523 4088 E-mail: agc@agccert.com Web: http://www.agccert.com/

### 5.3 TRANSMITTER OUT OF BAND (OOB) EMISSIONS

#### MEASUREMENT EQUIPMENT USED:

NAME OF EQUIPMENT	MANUFACTURER	MODEL	S/N	Cal. Date	Cal. Due
Test Receiver	R&S	ESCI	10096	Feb. 18, 2023	Feb. 17, 2024
Power amplifier	AR	75A250	18464	N/A	N/A
Active Loop Antenna (9K-30Mhz)	ZHINAN	ZN30900C	18051	Mar. 12, 2022	Mar. 11, 2024

#### TEST SETUP:

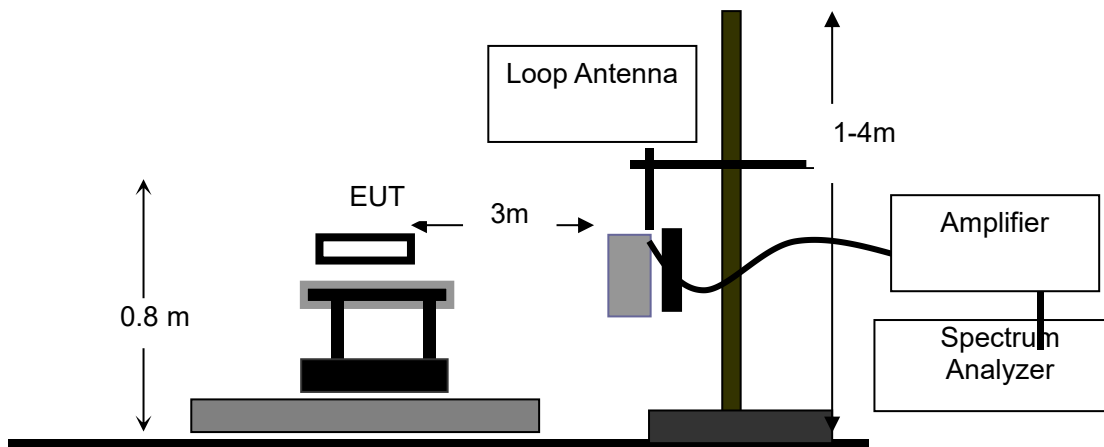

#### TEST PROCEDURE:

- 1). The EUT was placed on a turn table which is 0.8m above ground plane.
- 2). The EUT was modulated by normal signal,
- 3). Set SPA Center Frequency = fundamental frequency, RBW=VBW=200Hz, Span=5KHz, Detector=RMS. The 99 % OBW function shall be used to determine the operating frequency range, fH is the frequency of the upper marker resulting from the OFR, fL is the frequency of the lower marker resulting from the OFR.
- 4). Both normal test condition and extreme test condition applied

Any report having not been signed by authorized approver, or having been altered without authorization, or having not been stamped by the "Dedicated Testing/Inspection Stamp" is deemed to be invalid. Copying or excerpting portion of, or altering the content of the report is not permitted without the written authorization of AGC. The test results presented in the report apply only to the tested sample. Any objections to report issued by AGC should be submitted to AGC within 15days after the issuance of the test report. Further enquiry of validity or verification of the test report should be addressed to AGC by agc01@agccert.com.

### LIMITS

The OOB limits are visualized in figures; they are descending from the intentional limits from Table 3 at fH/fL with 10 dB/decade.

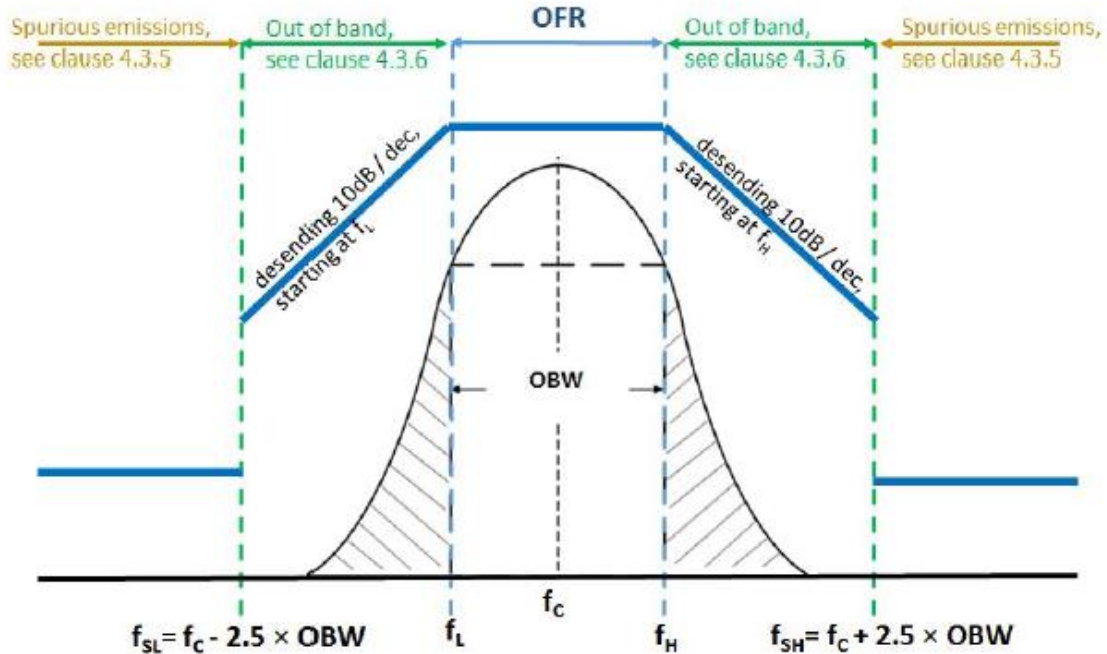

Figure 4: Out of band and spurious domain of a single frequency WPT system

### TEST RESULT

Test Mode: Mode 1

Frequency range (KHz)	Maximum level @10m (dBuA/m)	Limit @ 10m (dBuA/m)	Result	
fSL -fL	136.61 to 138.282	Less than -20.48	See figure 4	Pass
fL	138.282	-20.48	42.00	Pass
fH	139.118	-21.00	42.00	Pass
fH - fSH	139.118 to 140.79	Less than -21	See figure 4	Pass

Test Mode: Mode 3

Frequency range (KHz)	Maximum level @10m (dBuA/m)	Limit @ 10m (dBuA/m)	Result	
fSL-fL	130.733 to 132.387	Less than -5.5	See figure 4	Pass
fL	132.387	-5.50	31.20	Pass
fH	133.214	-6.02	31.20	Pass
fH-fSH	133.214 to 134.868	Less than -6.02	See figure 4	Pass

Any report having not been signed by authorized approver, or having been altered without authorization, or having not been stamped by the "Dedicated Testing/Inspection Stamp" is deemed to be invalid. Copying or excerpting portion of, or altering the content of the report is not permitted without the written authorization of AGC. The test results presented in the report apply only to the tested sample. Any objections to report issued by AGC should be submitted to AGC within 15days after the issuance of the test report. Further enquiry of validity or verification of the test report should be addressed to AGC by agc01@agccert.com.



Test Mode: Mode 4

Frequency range (KHz)		Maximum level @10m (dBuA/m)	Limit @ 10m (dBuA/m)	Result
fSL-fL	133.99 to 135.926	Less than -13.54	See figure 4	Pass
fL	135.926	-13.54	42.00	Pass
fH	139.243	-25.23	42.00	Pass
fH-fSH	139.243 to 141.175	Less than -25.23	See figure 4	Pass

**NOTE:** All the modes had been tested, but only the worst data recorded in the report.

Any report having not been signed by authorized approver, or having been altered without authorization, or having not been stamped by the "Dedicated Testing/Inspection Stamp" is deemed to be invalid. Copying or excerpting portion of, or altering the content of the report is not permitted without the written authorization of AGC. The test results presented in the report apply only to the tested sample. Any objections to report issued by AGC should be submitted to AGC within 15days after the issuance of the test report. Further enquiry of validity or verification of the test report should be addressed to AGC by [agc01@agccert.com](mailto:agc01@agccert.com).

Attestation of Global Compliance(Shenzhen)Co., Ltd

Attestation of Global Compliance(Shenzhen)Std &amp; Tech Co., Ltd

 Tel: +86-755 2523 4088 E-mail: [agc@agccert.com](mailto:agc@agccert.com) Web: <http://www.agccert.com/>

### 5.4 TRANSMITTER SPURIOUS EMISSIONS

#### MEASUREMENT EQUIPMENT USED:

NAME OF EQUIPMENT	MANUFACTURER	MODEL	S/N	Cal. Date	Cal. Due
Test Receiver	R&S	ESCI	10096	Feb. 18, 2023	Feb. 17, 2024
Power amplifier	AR	75A250	18464	N/A	N/A
Active Loop Antenna (9K-30Mhz)	ZHINAN	ZN30900C	18051	Mar. 12, 2022	Mar. 11, 2024
Wideband Antenna	SCHWARZBECK	VULB9168	VULB9168-494	Jan. 05, 2023	Jan. 04, 2025

#### TEST SETUP:

##### FREQUENCY RANGE (9KHZ-30MHZ)

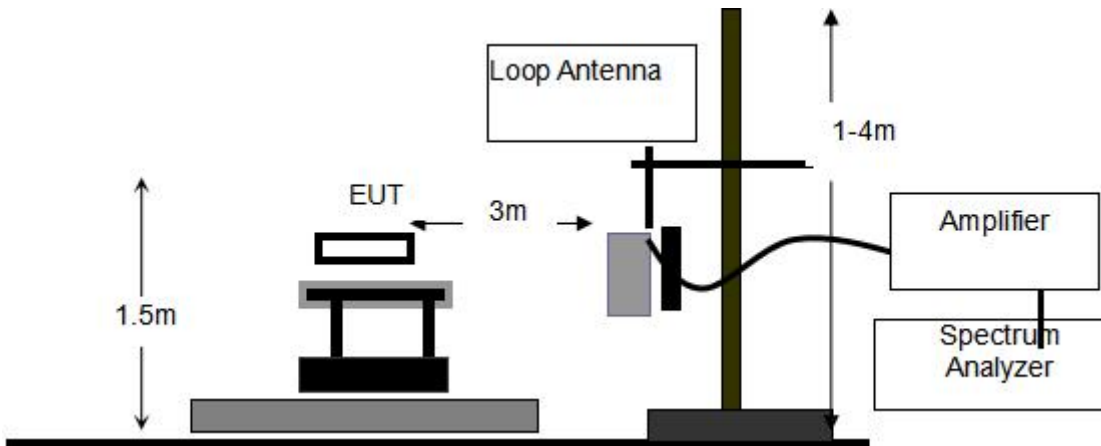

##### FREQUENCY RANGE (ABOVE 30MHZ)

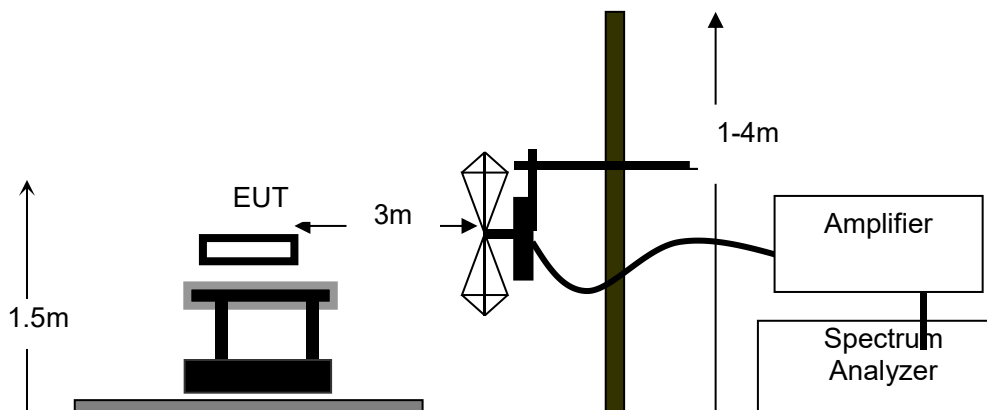

Any report having not been signed by authorized approval or having been altered without authorization is deemed to be invalid. Copying or excerpting portion of, or altering the content of the report is not permitted without the written authorization of AGC. The test results presented in the report apply only to the tested sample. Any objections to report issued by AGC should be submitted to AGC within 15days after the issuance of the test report. Further enquiry of validity or verification of the test report should be addressed to AGC by agc01@agccert.com.

**SUBSTITUTION METHOD:**

RADIATED BELOW 1GHZ

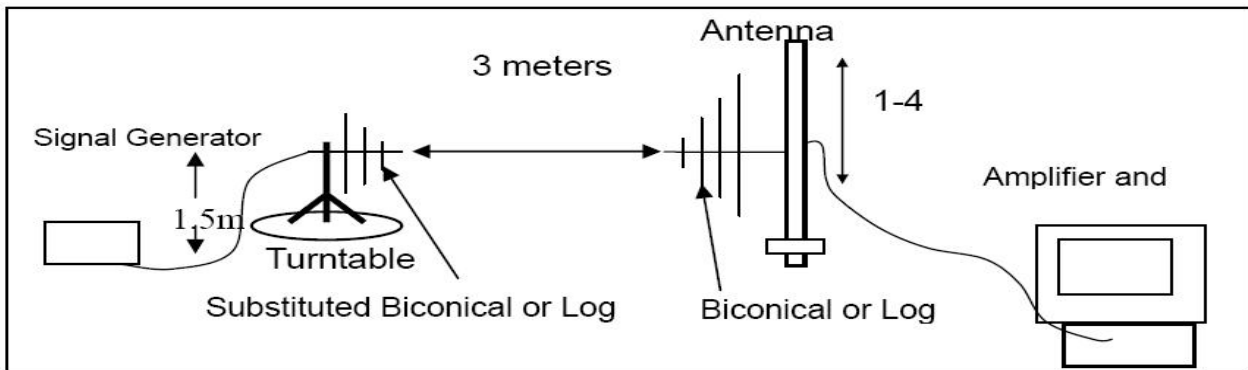

**TEST PROCEDURE:**

For test method of frequency range (9kHz-30MHz)

The EUT was placed on the top of an insulating table 1.5 meters above the ground at a semi-anechoic chamber. The table was rotated 360 degrees to determine the position of the highest radiation.

The EUT was set 3 meters away from the interference-receiving antenna, which was mounted on the top of a variable-height antenna tower.

The H-field is measured with a shielded loop antenna connected to a measurement receiver.

The measuring bandwidth and detector type of the measurement receiver shall be in accordance with EN 300 330 Table 1.

For test method of frequency range (30 MHz-1000MHz)

EUT was placed on a 1.5m height wooden table. The search antenna is placed at 3m distances from the EUT and search antenna height is from 1-4m. With the transmitter operating at continuously mode, the turntable was slowly rotated to locate the direction of maximum emission. Once maximum direction is determined, the search antenna was raised and lowered in both vertical and horizontal polarizations.

The EUT was removed from the turntable and replaced with a linearly polarized antenna connected to a calibrated RF signal generator. The RF generator was set to a measured emission frequency and the search antenna was raised and lowered to produce a maximum received reading. The generator output was increased to match the radiated emission reading measured previously, and the result expressed in dB EIRP or ERP, correcting for substitution antenna gain at each frequency.

Any report having not been signed by authorized approver, or having been altered without authorization, or having not been stamped by the "Dedicated Testing/Inspection Stamp" is deemed to be invalid. Copying or excerpting portion of, or altering the content of the report is not permitted without the written authorization of AGC. The test results presented in the report apply only to the tested sample. Any objections to report issued by AGC should be submitted to AGC within 15days after the issuance of the test report. Further enquiry of validity or verification of the test report should be addressed to AGC by agc01@agccert.com.

**LIMITS OF RADIATED DISTURBANCES**

Below 30MHz

**Table 4**

State (see note)	Frequency $9\text{ kHz} \leq f < 10\text{ MHz}$	Frequency $10\text{ MHz} \leq f < 30\text{ MHz}$
<b>Operating</b>	27 dB $\mu$ A/m at 9 kHz descending 10 dB/dec	-3,5 dB $\mu$ A/m
<b>Standby</b>	5,5 dB $\mu$ A/m at 9 kHz descending 10 dB/dec	-25 dB $\mu$ A/m
NOTE: "Operating" means mode 2, 3 and 4 according to Table 2; "standby" means mode 1 according to Table 2.		

ABOVE 30MHz

**Table 5**

State (see note)	47 MHz to 74 MHz 87,5 MHz to 118 MHz 174 MHz to 230 MHz 470 MHz to 790 MHz	Other frequencies between 30 MHz to 1 000 MHz
<b>Operating</b>	4 nW	250 nW
<b>Standby</b>	2 nW	2 nW
NOTE: "Operating" means mode 2, 3 and 4 according to Table 2; "standby" means mode 1 according to Table 2.		

Any report having not been signed by authorized approver, or having been altered without authorization, or having not been stamped by the "Dedicated Testing/Inspection Stamp" is deemed to be invalid. Copying or excerpting portion of, or altering the content of the report is not permitted without the written authorization of AGC. The test results presented in the report apply only to the tested sample. Any objections to report issued by AGC should be submitted to AGC within 15days after the issuance of the test report. Further enquiry of validity or verification of the test report should be addressed to AGC by agc01@agccert.com.

**TEST LIMITS & RESULT**

**Test Mode: Mode 3**

**FREQUENCY RANGE (9KHZ-30MHZ)**

Operation Mode					
Frequency (MHz)	Reading level (dB $\mu$ A)	Total Factor (dB/m )	Emission level (dB $\mu$ A/m)	Limit (dB $\mu$ A/m)	Margin (dB $\mu$ A/m)
0.064	-7.93	-7.96	-15.89	18.51	34.40
0.291	-11.34	-7.96	-19.30	11.91	31.21
0.540	-12.80	-7.96	-20.76	9.22	29.98
1.883	-14.53	-3.98	-18.51	3.79	22.30
3.311	-13.38	-3.09	-16.47	1.34	17.81
3.985	-12.68	-1.25	-13.93	0.54	14.47

Remark:

- (1) Corrected Power (dBm)= Total Factor + Reading Level
- (2) Measuring frequencies from 9KHz to the 30MHz.
- (3) Data of measurement within this frequency range shown “ -- ” in the table above means the reading of emissions are attenuated more than 20dB below the permissible limits or the field strength is too small to be measured.

Any report having not been signed by authorized approver, or having been altered without authorization, or having not been stamped by the “Dedicated Testing/Inspection Stamp” is deemed to be invalid. Copying or excerpting portion of, or altering the content of the report is not permitted without the written authorization of AGC. The test results presented in the report apply only to the tested sample. Any objections to report issued by AGC should be submitted to AGC within 15days after the issuance of the test report. Further enquiry of validity or verification of the test report should be addressed to AGC by agc01@agccert.com.

**FREQUENCY RANGE (ABOVE 30MHZ)**

Transmitter Spurious Emission below 1GHz (30MHz-1GHz)

Frequency	Reading Level	Antenna	S.G.	Cable Loss	Ant.Gain	Emission Level	Limit	Margin
(MHz)	(dBuV/m)	Polarization	(dBm)	(dB)	(dBi)	(dBm)	(dBm)	(dB)
76.35	32.84	V	-59.11	0.04	-0.90	-60.05	-36.00	24.05
162.66	28.17	V	-66.88	0.06	1.36	-65.58	-36.00	29.58
354.20	31.40	V	-68.52	0.25	6.02	-62.75	-36.00	26.75
424.86	26.32	V	-74.43	0.33	7.02	-67.75	-36.00	31.75
630.38	29.81	V	-69.99	0.52	7.30	-63.20	-54.00	9.20
758.94	28.06	V	-71.15	0.61	6.50	-65.26	-36.00	29.26
82.64	31.16	H	-62.13	0.04	0.22	-61.95	-36.00	25.95
156.50	27.72	H	-67.02	0.06	0.80	-66.28	-36.00	30.28
348.46	29.77	H	-68.36	0.24	5.54	-63.06	-36.00	27.06
430.92	27.00	H	-72.24	0.34	6.90	-65.68	-36.00	29.68
630.01	30.00	H	-70.82	0.52	7.30	-64.04	-54.00	10.04
726.93	27.03	H	-71.30	0.59	6.60	-65.28	-36.00	29.28

Note: 1.The margins of the other spectrum are not exceeding the minimum value of margin, and this part of the results without recording in the test report.

2. Measurements above show only up to 6 maximum emissions noted, or would be lesser, with "--" remark, if no specific emission from the EUT are recorded (ie: margin>20dB from the applicable limit) and considered that's already beyond the background noise floor.

Any report having not been signed by authorized approver, or having been altered without authorization, or having not been stamped by the "Dedicated Testing/Inspection Stamp" is deemed to be invalid. Copying or excerpting portion of, or altering the content of the report is not permitted without the written authorization of AGC. The test results presented in the report apply only to the tested sample. Any objections to report issued by AGC should be submitted to AGC within 15days after the issuance of the test report. Further enquiry of validity or verification of the test report should be addressed to AGC by agc01@agccert.com.

**Test Mode: Mode 4(The low channel is the worst case)**  
**FREQUENCY RANGE (9KHZ-30MHZ)**

Operation Mode					
Frequency	Reading level	Total Factor	Emission level	Limit	Margin
(MHz)	(dB $\mu$ A)	(dB/m )	(dB $\mu$ A/m)	(dB $\mu$ A/m)	(dB $\mu$ A/m)
0.053	-8.04	-7.96	-16.00	19.34	35.34
0.293	-11.12	-7.96	-19.08	11.88	30.95
0.566	-12.62	-7.96	-20.58	9.01	29.60
1.838	-14.70	-3.98	-18.68	3.90	22.58
3.061	-13.46	-3.09	-16.55	1.68	18.23
3.065	-12.36	-1.25	-13.61	1.68	15.29

Remark:

- (1) Corrected Power (dBm) = Total Factor + Reading Level
- (2) Measuring frequencies from 9KHz to the 30MHz.
- (3) Data of measurement within this frequency range shown "--" in the table above means the reading of emissions are attenuated more than 20dB below the permissible limits or the field strength is too small to be measured.

Any report having not been signed by authorized approver, or having been altered without authorization, or having not been stamped by the "Dedicated Testing/Inspection Stamp" is deemed to be invalid. Copying or excerpting portion of, or altering the content of the report is not permitted without the written authorization of AGC. The test results presented in the report apply only to the tested sample. Any objections to report issued by AGC should be submitted to AGC within 15days after the issuance of the test report. Further enquiry of validity or verification of the test report should be addressed to AGC by agc01@agccert.com.

**FREQUENCY RANGE (ABOVE 30MHZ)**
**Transmitter Spurious Emission below 1GHz (30MHz-1GHz)**

Frequency	Reading Level	Antenna	S.G.	Cable Loss	Ant.Gain	Emission Level	Limit	Margin
(MHz)	(dBuV/m)	Polarization	(dBm)	(dB)	(dBi)	(dBm)	(dBm)	(dB)
83.64	31.43	V	-62.22	0.04	0.38	-61.88	-36.00	25.88
157.25	27.06	V	-67.43	0.06	0.90	-66.59	-36.00	30.59
355.70	30.90	V	-68.09	0.25	6.15	-62.19	-36.00	26.19
429.52	26.63	V	-72.56	0.34	6.92	-65.98	-36.00	29.98
627.35	29.71	V	-70.50	0.51	7.18	-63.83	-54.00	9.83
759.14	27.76	V	-72.26	0.61	6.55	-66.32	-36.00	30.32
92.74	30.49	H	-63.33	0.04	1.56	-61.81	-54.00	7.81
156.84	26.61	H	-67.21	0.06	0.80	-66.47	-36.00	30.47
350.84	28.62	H	-69.88	0.25	5.50	-64.62	-36.00	28.62
434.67	27.87	H	-72.08	0.34	6.62	-65.80	-36.00	29.80
631.83	28.11	H	-71.41	0.52	7.28	-64.65	-54.00	10.65
729.32	28.20	H	-70.63	0.59	6.75	-64.47	-36.00	28.47

Note: 1.The margins of the other spectrum are not exceeding the minimum value of margin, and this part of the results without recording in the test report.

2. Measurements above show only up to 6 maximum emissions noted, or would be lesser, with "--" remark, if no specific emission from the EUT are recorded (ie: margin>20dB from the applicable limit) and considered that's already beyond the background noise floor.



**Test Mode: Mode 1**  
**FREQUENCY RANGE (9KHZ-30MHZ)**

Standby Mode					
Frequency	Reading level	Total Factor	Emission level	Limit	Margin
(MHz)	(dB $\mu$ A)	(dB/m )	(dB $\mu$ A/m)	(dB $\mu$ A/m)	(dB $\mu$ A/m)
0.034	-7.51	-7.96	-15.47	-0.21	15.26
0.309	-10.20	-7.96	-18.16	-9.86	8.30
0.499	-11.51	-7.96	-19.47	-11.94	7.54
2.017	-23.00	-3.98	-26.98	-18.00	8.97
2.659	-28.08	-3.09	-31.17	-19.20	11.97
4.552	-26.55	-1.25	-27.80	-21.54	6.26

Remark:

- (1) Corrected Power (dBm) = Total Factor + Reading Level
- (2) Measuring frequencies from 9KHz to the 30MHz.
- (3) Data of measurement within this frequency range shown "--" in the table above means the reading of emissions are attenuated more than 20dB below the permissible limits or the field strength is too small to be measured.

Any report having not been signed by authorized approver, or having been altered without authorization, or having not been stamped by the "Dedicated Testing/Inspection Stamp" is deemed to be invalid. Copying or excerpting portion of, or altering the content of the report is not permitted without the written authorization of AGC. The test results presented in the report apply only to the tested sample. Any objections to report issued by AGC should be submitted to AGC within 15days after the issuance of the test report. Further enquiry of validity or verification of the test report should be addressed to AGC by agc01@agccert.com.

**FREQUENCY RANGE (ABOVE 30MHZ)**

Transmitter Spurious Emission below 1GHz (30MHz-1GHz)

Frequency	Reading Level	Antenna	S.G.	Cable Loss	Ant.Gain	Emission Level	Limit	Margin
(MHz)	(dBuV/m)	Polarization	(dBm)	(dB)	(dBi)	(dBm)	(dBm)	(dB)
94.36	27.80	V	-67.35	0.04	1.72	-65.67	-57.00	8.67
160.54	28.13	V	-65.81	0.06	1.20	-64.67	-57.00	7.67
357.29	28.43	V	-71.81	0.25	6.41	-65.65	-57.00	8.65
535.51	26.50	V	-72.93	0.45	6.90	-66.47	-57.00	9.47
673.64	30.89	V	-68.64	0.55	6.68	-62.50	-57.00	5.50
832.79	29.97	V	-69.46	0.66	6.44	-63.68	-57.00	6.68
132.51	28.51	H	-64.78	0.05	0.06	-64.77	-57.00	7.77
164.60	28.86	H	-66.73	0.06	1.52	-65.27	-57.00	8.27
342.71	29.99	H	-68.36	0.24	5.66	-62.93	-57.00	5.93
537.03	28.02	H	-72.60	0.45	7.02	-66.02	-57.00	9.02
676.88	28.84	H	-69.96	0.55	6.56	-63.95	-57.00	6.95
828.83	28.58	H	-69.47	0.66	6.40	-63.73	-57.00	6.73

Note: 1.The margins of the other spectrum are not exceeding the minimum value of margin, and this part of the results without recording in the test report.

2. Measurements above show only up to 6 maximum emissions noted, or would be lesser, with "--" remark, if no specific emission from the EUT are recorded (ie: margin>20dB from the applicable limit) and considered that's already beyond the background noise floor.

Any report having not been signed by authorized approver, or having been altered without authorization, or having not been stamped by the "Dedicated Testing/Inspection Stamp" is deemed to be invalid. Copying or excerpting portion of, or altering the content of the report is not permitted without the written authorization of AGC. The test results presented in the report apply only to the tested sample. Any objections to report issued by AGC should be submitted to AGC within 15days after the issuance of the test report. Further enquiry of validity or verification of the test report should be addressed to AGC by agc01@agccert.com.

### 5.5 RECEIVER BLOCKING

#### MEASUREMENT EQUIPMENT USED:

NAME OF EQUIPMENT	MANUFACTURER	MODEL	S/N	Cal. Date	Cal. Due
MXG X-Series Vector Signal Generator	Agilent	N5182B	MY53050647	Mar. 03, 2023	Mar. 02, 2024
Active Loop Antenna (9K-30Mhz)	ZHINAN	ZN30900C	18051	Mar. 12, 2022	Mar. 11, 2024
Clamp meter	PROVA	PROVA-11	17200101	Sep. 11, 2023	Sep. 12, 2024

#### TEST SETUP:

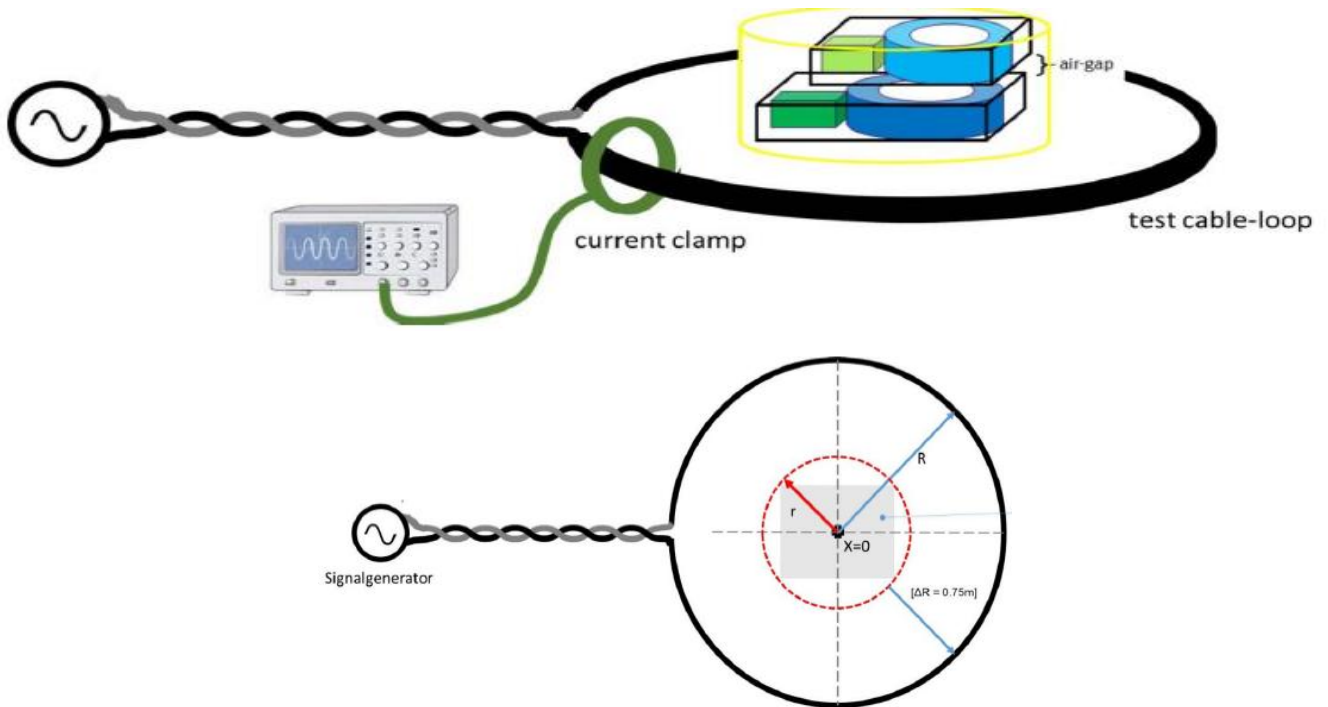

#### TEST PROCEDURE:

- 1). The test shall be carried out inside a test chamber according to clauses C.1.1 and C.1.2 in ETSI EN 300 330
- 2). A test loop with a radius r shall be used to create the magnetic field; the test loop shall lie on a non-metallic ground and the minimum distance to metallic objects (e.g. ground plane) shall be 0,75 m. The EUT shall be placed to the centre of the test-loop
- 3). The test loop shall be sufficiently large so that the test loop itself does not influence the WPT system; The radius R of the test-loop shall be in minimum  $\Delta R = 0,75\text{ m}$  larger than the maximum dimension r of the EUT.

$$R \geq r + \Delta R.$$

The maximum H-Field can be calculated from the loop current I (into the test-loop) with the following formula:

$$H = I/2R$$

Any report having not been signed by authorized approver, or having been altered without authorization, or having not been stamped by the "Dedicated Testing/Inspection Stamp" is deemed to be invalid. Copying or excerpting portion of, or altering the content of the report is not permitted without the written authorization of AGC. The test results presented in the report apply only to the tested sample. Any objections to report issued by AGC should be submitted to AGC within 15 days after the issuance of the test report. Further enquiry of validity or verification of the test report should be addressed to AGC by agc01@agccert.com.

4)The required output current to achieve the required magnetic field at the WPT system shall be generated with a signal generator (unmodulated signal) at the test frequencies. For each test frequency the "reaction" of the device shall be recorded and checked against the performance criterion

## LIMITS

The EUT shall achieve the wanted performance criterion, in the presence of the blocking signal.

**Table 6: Receiver blocking limits**

	<b>In-band signal</b>	<b>OOB signal</b>	<b>Remote-band signal</b>
Frequency	Centre frequency ( $f_c$ ) of the WPT system (see clause 4.3.3)	$f = f_c \pm F$ (see note)	$f = f_c \pm 10 \times F$ (see note)
Signal level field strength at the EUT	72 dB $\mu$ A/m	72 dB $\mu$ A/m	82 dB $\mu$ A/m
NOTE: F = OFR see clause 4.3.3.			

## TEST RESULT

Test Mode: Mode 1

Test Frequency(KHz)		Signal level @ EUT	Performance	Result
In-band signal	138.700	72dBuA/m	No function loss	Pass
OOB signal	137.864	72dBuA/m	No function loss	Pass
	139.536	72dBuA/m	No function loss	Pass
Remote-band signal	130.340	82dBuA/m	No function loss	Pass
	147.060	82dBuA/m	No function loss	Pass

Test Mode: Mode 3

Test Frequency(KHz)		Signal level @ EUT	Performance	Result
In-band signal	132.800	72dBuA/m	No function loss	Pass
OOB signal	131.973	72dBuA/m	No function loss	Pass
	133.627	72dBuA/m	No function loss	Pass
Remote-band signal	124.530	82dBuA/m	No function loss	Pass
	141.070	82dBuA/m	No function loss	Pass

Any report having not been signed by authorized approver, or having been altered without authorization, or having not been stamped by the "Dedicated Testing/Inspection Stamp" is deemed to be invalid. Copying or excerpting portion of, or altering the content of the report is not permitted without the written authorization of AGC. The test results presented in the report apply only to the tested sample. Any objections to report issued by AGC should be submitted to AGC within 15days after the issuance of the test report. Further enquiry of validity or verification of the test report should be addressed to AGC by agc01@agccert.com.

Attestation of Global Compliance(Shenzhen)Co., Ltd

Attestation of Global Compliance(Shenzhen)Std & Tech Co., Ltd

Tel: +86-755 2523 4088 E-mail: agc@agccert.com Web: http://www.agccert.com/

## 6. INTERPRETATION OF MEASUREMENT RESULTS

All the measurement equipments and accessories have been carefully selected to meet the maximum measurement uncertainty specified below:

RF Frequency	$\pm 1 \times 10^{-7}$
RF Power, Conducted	$\pm 0.75\text{dB}$
Maximum Frequency Deviation: _ Within 300Hz and 6KHz of Audio Frequency _ Within 6KHz and 25KHz of Audio Frequency	$\pm 5\%$ $\pm 3\text{dB}$
Adjacent channel power	$\pm 3\text{dB}$
Conducted Emission of Transmitter, Valid Up to 12.75GHz	$\pm 4\text{dB}$
Conducted Emissions of Receivers	$\pm 3\text{dB}$
Radiated Emission of Transmitter, Valid Up to 12.75GHz	$\pm 6\text{dB}$

P.S. Uncertainty figures are valid to confidence level of 95% calculated according to the methods described in the ETSI TR 100 028.

Any report having not been signed by authorized approver, or having been altered without authorization, or having not been stamped by the "Dedicated Testing/Inspection Stamp" is deemed to be invalid. Copying or excerpting portion of, or altering the content of the report is not permitted without the written authorization of AGC. The test results presented in the report apply only to the tested sample. Any objections to report issued by AGC should be submitted to AGC within 15days after the issuance of the test report. Further enquiry of validity or verification of the test report should be addressed to AGC by [agc01@agccert.com](mailto:agc01@agccert.com).

**APPENDIX A: PHOTOGRAPHS OF TEST SETUP**

Any report having not been signed by authorized approver, or having been altered without authorization, or having not been stamped by the “Dedicated Testing/Inspection Stamp” is deemed to be invalid. Copying or excerpting portion of, or altering the content of the report is not permitted without the written authorization of AGC. The test results presented in the report apply only to the tested sample. Any objections to report issued by AGC should be submitted to AGC within 15days after the issuance of the test report. Further enquiry of validity or verification of the test report should be addressed to AGC by [agc01@agccert.com](mailto:agc01@agccert.com).

Attestation of Global Compliance(Shenzhen)Co., Ltd

Attestation of Global Compliance(Shenzhen)Std & Tech Co., Ltd

Tel: +86-755 2523 4088 E-mail: [agc@agccert.com](mailto:agc@agccert.com) Web: <http://www.agccert.com/>

## **APPENDIX B: PHOTOGRAPHS OF THE EUT**

Refer to the Report No.: AGC05443240102AP01A

**----END OF REPORT----**

Any report having not been signed by authorized approver, or having been altered without authorization, or having not been stamped by the "Dedicated Testing/Inspection Stamp" is deemed to be invalid. Copying or excerpting portion of, or altering the content of the report is not permitted without the written authorization of AGC. The test results presented in the report apply only to the tested sample. Any objections to report issued by AGC should be submitted to AGC within 15days after the issuance of the test report. Further enquiry of validity or verification of the test report should be addressed to AGC by [agc01@agccert.com](mailto:agc01@agccert.com).

Attestation of Global Compliance(Shenzhen)Co., Ltd

Attestation of Global Compliance(Shenzhen)Std & Tech Co., Ltd

Tel: +86-755 2523 4088 E-mail: [agc@agccert.com](mailto:agc@agccert.com) Web: <http://www.agccert.com/>



## Conditions of Issuance of Test Reports

1. All samples and goods are accepted by the Attestation of Global Compliance (Shenzhen) Co., Ltd (the “Company”) solely for testing and reporting in accordance with the following terms and conditions. The company provides its services on the basis that such terms and conditions constitute express agreement between the company and any person, firm or company requesting its services (the “Clients”).
2. Any report issued by Company as a result of this application for testing services (the “Report”) shall be issued in confidence to the Clients and the Report will be strictly treated as such by the Company. It may not be reproduced either in its entirety or in part and it may not be used for advertising or other unauthorized purposes without the written consent of the Company. The Clients to whom the Report is issued may, however, show or send it, or a certified copy thereof prepared by the Company to its customer, supplier or other persons directly concerned. The Company will not, without the consent of the Clients, enter into any discussion or correspondence with any third party concerning the contents of the Report, unless required by the relevant governmental authorities, laws or court orders.
3. The Company shall not be called or be liable to be called to give evidence or testimony on the Report in a court of law without its prior written consent, unless required by the relevant governmental authorities, laws or court orders.
4. In the event of the improper use of the report as determined by the Company, the Company reserves the right to withdraw it, and to adopt any other additional remedies which may be appropriate.
5. Samples submitted for testing are accepted on the understanding that the Report issued cannot form the basis of, or be the instrument for, any legal action against the Company.
6. The Company will not be liable for or accept responsibility for any loss or damage however arising from the use of information contained in any of its Reports or in any communication whatsoever about its said tests or investigations.
7. Clients wishing to use the Report in court proceedings or arbitration shall inform the Company to that effect prior to submitting the sample for testing.
8. The Company is not responsible for recalling the electronic version of the original report when any revision is made to them. The Client assumes the responsibility to providing the revised version to any interested party who uses them.
9. Subject to the variable length of retention time for test data and report stored hereinto as otherwise specifically required by individual accreditation authorities, the Company will only keep the supporting test data and information of the test report for a period of six years. The data and information will be disposed of after the aforementioned retention period has elapsed. Under no circumstances shall we provide any data and information which has been disposed of after retention period. Under no circumstances shall we be liable for damage of any kind, including (but not limited to) compensatory damages, lost profits, lost data, or any form of special, incidental, indirect, consequential or punitive damages of any kind, whether based on breach of contract of warranty, tort (including negligence), product liability or otherwise, even if we are informed in advance of the possibility of such damages.

Any report having not been signed by authorized approver, or having been altered without authorization, or having not been stamped by the “Dedicated Testing/Inspection Stamp” is deemed to be invalid. Copying or excerpting portion of, or altering the content of the report is not permitted without the written authorization of AGC. The test results presented in the report apply only to the tested sample. Any objections to report issued by AGC should be submitted to AGC within 15 days after the issuance of the test report. Further enquiry of validity or verification of the test report should be addressed to AGC by [agc01@agccert.com](mailto:agc01@agccert.com).



---

# Health Test Report

---

Report No.: AGC05443240102EH01A

**PRODUCT DESIGNATION** : Magnetic Wireless charger  
**BRAND NAME** : N/A  
**MODEL NAME** : MO6253  
**APPLICANT** : MID OCEAN BRANDS B.V  
**DATE OF ISSUE** : Jun. 18, 2024  
**STANDARD(S)** : EN IEC 62311:2020  
: EN 50665:2017  
**REPORT VERSION** : V1.0



Attestation of Global Compliance (Shenzhen) Co., Ltd.

Any report having not been signed by authorized approver, or having been altered without authorization, or having not been stamped by the "Dedicated Testing/Inspection Stamp" is deemed to be invalid. Copying or excerpting portion of, or altering the content of the report is not permitted without the written authorization of AGC. The test results presented in the report apply only to the tested sample. Any objections to report issued by AGC should be submitted to AGC within 15days after the issuance of the test report. Further enquiry of validity or verification of the test report should be addressed to AGC by agc01@agccert.com.

Attestation of Global Compliance(Shenzhen)Co., Ltd  
Attestation of Global Compliance(Shenzhen)Std & Tech Co., Ltd  
Tel: +86-755 2523 4088 E-mail: agc@agccert.com Web: <http://www.agccert.com/>



**REPORT REVISE RECORD**

Report Version	Revise Time	Issued Date	Valid Version	Notes
V1.0	/	Jun. 18, 2024	Valid	Initial release

Note: The original test report AGC05443240102EH01 (dated Jan. 30, 2024 and tested from Jan. 04, 2024 to Jan. 30, 2024) was modified on Jun. 18, 2024, including the following changes and additions:

- Changed the Test Model Name.
- Changed the shell material and photo of the EUT.

For the above described changes, RF EXPOSURE MEASUREMENT test was considered to be necessary.

Any report having not been signed by authorized approver, or having been altered without authorization, or having not been stamped by the "Dedicated Testing/Inspection Stamp" is deemed to be invalid. Copying or excerpting portion of, or altering the content of the report is not permitted without the written authorization of AGC. The test results presented in the report apply only to the tested sample. Any objections to report issued by AGC should be submitted to AGC within 15days after the issuance of the test report. Further enquiry of validity or verification of the test report should be addressed to AGC by agc01@agccert.com.

**TABLE OF CONTENTS**

**1. GENERAL INFORMATION ..... 4**

**2. TECHNICAL INFORMATION ..... 5**

**3. EN 62311 RF EXPOSURE MEASUREMENT ..... 6**

    3.1 INTRODUCTION ..... 6

    3.2 TEST LIMIT ..... 7

    3.3 EVALUATION METHODS ..... 8

**4. TEST EQUIPMENT LIST ..... 9**

**5. EUT OPERATION CONDITION ..... 9**

**6. TEST RESULT ..... 10**

**7. CONCLUSION ..... 10**

**APPENDIX I: PHOTOGRAPHS OF TEST SETUP ..... 11**

Any report having not been signed by authorized approver, or having been altered without authorization, or having not been stamped by the “Dedicated Testing/Inspection Stamp” is deemed to be invalid. Copying or excerpting portion of, or altering the content of the report is not permitted without the written authorization of AGC. The test results presented in the report apply only to the tested sample. Any objections to report issued by AGC should be submitted to AGC within 15days after the issuance of the test report. Further enquiry of validity or verification of the test report should be addressed to AGC by agc01@agccert.com.

**1. GENERAL INFORMATION**

Applicant	MID OCEAN BRANDS B.V
Address	Unit 201 2/F,. Laford Centre, 838 Lai Chi Kok Road, Cheung Sha Wan, Kowloon, Hongkong
Manufacturer	MID OCEAN BRANDS B.V
Address	Unit 201 2/F,. Laford Centre, 838 Lai Chi Kok Road, Cheung Sha Wan, Kowloon, Hongkong
Factory	MID OCEAN BRANDS B.V
Address	Unit 201 2/F,. Laford Centre, 838 Lai Chi Kok Road, Cheung Sha Wan, Kowloon, Hongkong
Product Designation	Magnetic Wireless charger
Brand Name	N/A
Test Model	MO6253
Series Model	N/A
Difference description	N/A
Date of receipt of test item	May 17, 2024
Date of test	N/A
Test Result	Pass

We (AGC), Attestation of Global Compliance (Shenzhen) Co., Ltd. for compliance with the requirements set forth in the European Standard EN IEC 62311:2020. The results of testing in this report apply to the product/system which was tested only.

Prepared By   
 \_\_\_\_\_  
 Cici Li  
 (Project Engineer) Jun. 18, 2024

Reviewed By   
 \_\_\_\_\_  
 Calvin Liu  
 (Reviewer) Jun. 18, 2024

Approved By   
 \_\_\_\_\_  
 Max Zhang  
 (Authorized Officer) Jun. 18, 2024

Any report having not been signed by authorized approver, or having been altered without authorization, or having not been stamped by the “Dedicated Testing/Inspection Stamp” is deemed to be invalid. Copying or excerpting portion of, or altering the content of the report is not permitted without the written authorization of AGC. The test results presented in the report apply only to the tested sample. Any objections to report issued by AGC should be submitted to AGC within 15days after the issuance of the test report. Further enquiry of validity or verification of the test report should be addressed to AGC by agc01@agccert.com.

## 2. TECHNICAL INFORMATION

Note: the following data is based on the information by the applicant.

Product Designation	Magnetic Wireless charger
Brand Name	N/A
Test Model	MO6253
Hardware Version	V1.0
Software Version	V1.0
Operation Frequency	110kHz-205kHz
Modulation type	ASK
Antenna Type	Coil Antenna
Antenna Gain	0dBi
EUT Input Rating	DC 9V 1.5A / DC 5V 2A
EUT Output Rating	DC 9V 1.1A / DC 5V 1A

**Note:** For more details, please refer to the user's manual of the EUT.

### 3. EN 62311 RF EXPOSURE MEASUREMENT

#### 3.1 INTRODUCTION

This International Standard applies to electronic and electrical equipment for which no dedicated product- or product family standard regarding human exposure to electromagnetic fields applies.

This generic standard applies to electronic and electrical apparatus for which no dedicated product- or product family standard regarding human exposure to electromagnetic fields applies.

The frequency range covered is 0 Hz to 300 GHz.

The object of this generic standard is to provide assessment methods and criteria to evaluate such equipment against basic restrictions or reference levels on exposure of the general public related to electric, magnetic, electromagnetic fields and induced and contact current.

**NOTE:** This standard is intended to cover both intentional and non-intentional radiators. If the equipment complies with the requirements in another relevant standard, e.g. EN 62479 covering low power equipment, then the requirements of this standard (IEC 62311) are considered to be met and the application of this standard to that equipment is not necessary.

### 3.2 TEST LIMIT

According to EN IEC 62311:2020, Assessment of electronic and electrical equipment related to human exposure restrictions for electromagnetic fields (0 Hz – 300 GHz).

#### Annex F Measurement of E and H field

A commonly used probe size is 100 cm<sup>2</sup>, also the contribution of the three axes X, Y and Z can be evaluated separately.

Reference levels for electric, magnetic and electromagnetic fields  
(0 Hz to 300 GHz, unperturbed rms values)

Frequency range	E-field strength (V/m)	H-field strength (A/m)	B-field (μT)	Equivalent plane wave power density $S_{eq}$ (W/m <sup>2</sup> )
0-1 Hz	—	$3,2 \times 10^4$	$4 \times 10^4$	—
1-8 Hz	10 000	$3,2 \times 10^4/f^2$	$4 \times 10^4/f^2$	—
8-25 Hz	10 000	$4\,000/f$	$5\,000/f$	—
0,025-0,8 kHz	$250/f$	$4/f$	$5/f$	—
0,8-3 kHz	$250/f$	5	6,25	—
3-150 kHz	87	5	6,25	—
0,15-1 MHz	87	$0,73/f$	$0,92/f$	—
1-10 MHz	$87/f^{1/2}$	$0,73/f$	$0,92/f$	—
10-400 MHz	28	0,073	0,092	2
400-2 000 MHz	$1,375 f^{1/2}$	$0,0037 f^{1/2}$	$0,0046 f^{1/2}$	$f/200$
2-300 GHz	61	0,16	0,20	10

Any report having not been signed by authorized approver, or having been altered without authorization, or having not been stamped by the “Dedicated Testing/Inspection Stamp” is deemed to be invalid. Copying or excerpting portion of, or altering the content of the report is not permitted without the written authorization of AGC. The test results presented in the report apply only to the tested sample. Any objections to report issued by AGC should be submitted to AGC within 15days after the issuance of the test report. Further enquiry of validity or verification of the test report should be addressed to AGC by agc01@agccert.com.

### 3.3 EVALUATION METHODS

#### Measurement of E and H field

A commonly used probe size is 100 cm<sup>2</sup>, also the contribution of the three axes X, Y and Z can be evaluated separately.

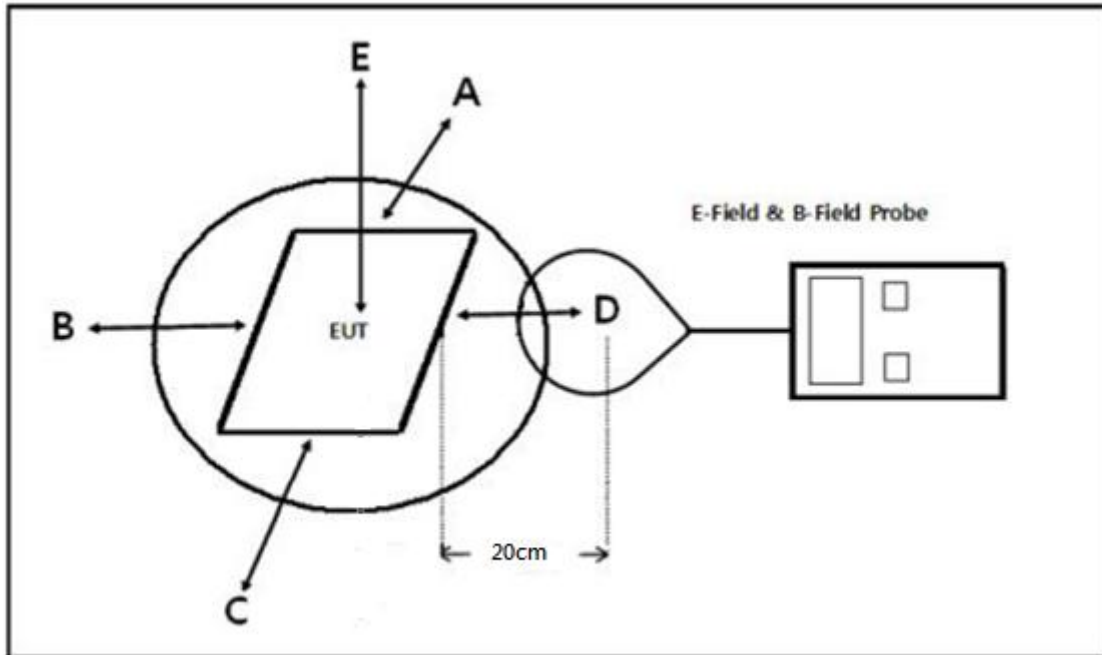

Note: Position A: Front of EUT; Position B: Left of EUT; Position C: back of EUT; Position D: Right of EUT; Position E: Top of EUT

Based on the above standard limit, any device with output power below 5A/m cannot produce an exposure exceeding this restriction under the most pessimistic exposure conditions.

Any report having not been signed by authorized approver, or having been altered without authorization, or having not been stamped by the "Dedicated Testing/Inspection Stamp" is deemed to be invalid. Copying or excerpting portion of, or altering the content of the report is not permitted without the written authorization of AGC. The test results presented in the report apply only to the tested sample. Any objections to report issued by AGC should be submitted to AGC within 15days after the issuance of the test report. Further enquiry of validity or verification of the test report should be addressed to AGC by agc01@agccert.com.



#### 4. TEST EQUIPMENT LIST

Description	Manufacturer	Model	S/N	Cal. Date	Cal. Due
Broadband Field Meter	WAVECONTROL	SMP2	J-0004	Feb. 24, 2023	Feb. 23, 2025
Probe FHP	WAVECONTROL	WP400	J-0015	Feb. 24, 2023	Feb. 23, 2025

#### 5. EUT OPERATION CONDITION

NO.	TEST MODE DESCRIPTION
1	Full Load mode
2	Half Load Mode
3	Null Load Mode

Note: 1. Note: All modes have been tested and only the worst mode test data recorded in the test report.

Any report having not been signed by authorized approver, or having been altered without authorization, or having not been stamped by the "Dedicated Testing/Inspection Stamp" is deemed to be invalid. Copying or excerpting portion of, or altering the content of the report is not permitted without the written authorization of AGC. The test results presented in the report apply only to the tested sample. Any objections to report issued by AGC should be submitted to AGC within 15days after the issuance of the test report. Further enquiry of validity or verification of the test report should be addressed to AGC by agc01@agccert.com.

## 6. TEST RESULT

Frequency (MHz)	Maximum Radiated H-Field at 5cm (A/m)		Limit (A/m)	Result (Pass/Fail)
110kHz-205kHz	position E	0.055	5	Pass
	position A	0.042		
	position B	0.031		
	position C	0.020		
	position D	0.026		

Since Radiated H-Field at worse case is 0.055A/m which cannot exceed the exempt condition, 5A/m. It is deemed to full fit the requirement of RF exposure basic restrisction specified in EC Council Recommendation (1999/519/EC).

## 7. CONCLUSION

Remark: EUT meets the basic requirements in the standard.

**APPENDIX I: PHOTOGRAPHS OF TEST SETUP**

WPT Equipment\_Position E

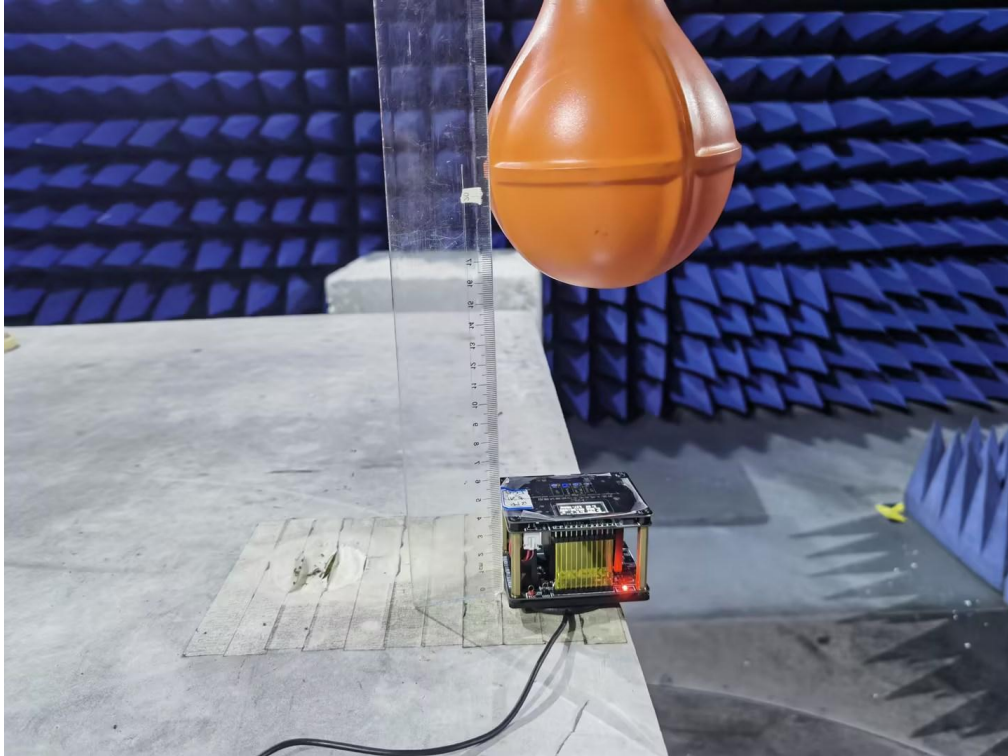

WPT Equipment\_Position A

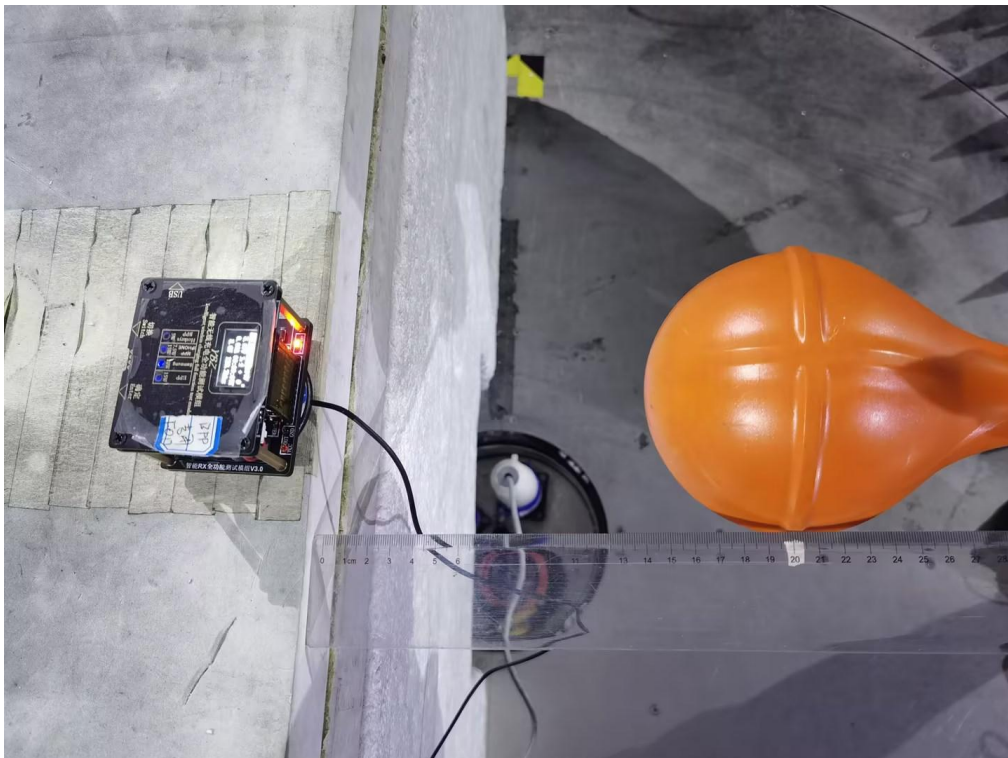

Any report having not been signed by authorized approver, or having been altered without authorization, or having not been stamped by the “Dedicated Testing/Inspection Stamp” is deemed to be invalid. Copying or excerpting portion of, or altering the content of the report is not permitted without the written authorization of AGC. The test results presented in the report apply only to the tested sample. Any objections to report issued by AGC should be submitted to AGC within 15days after the issuance of the test report. Further enquiry of validity or verification of the test report should be addressed to AGC by agc01@agccert.com.

WPT Equipment\_Position B

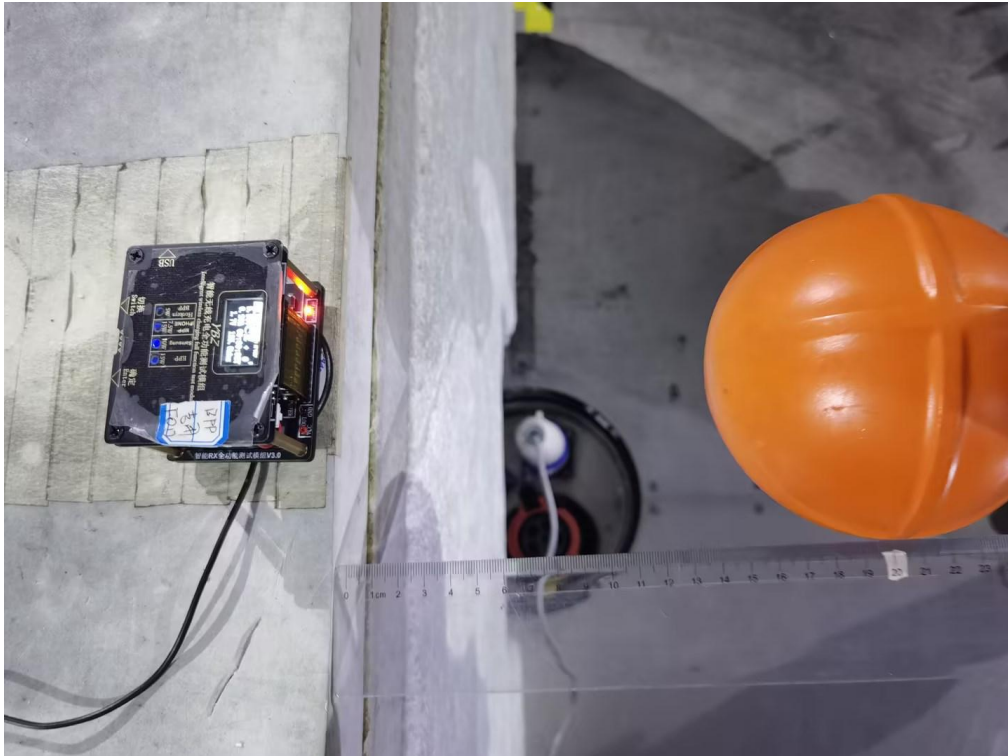

WPT Equipment\_Position C

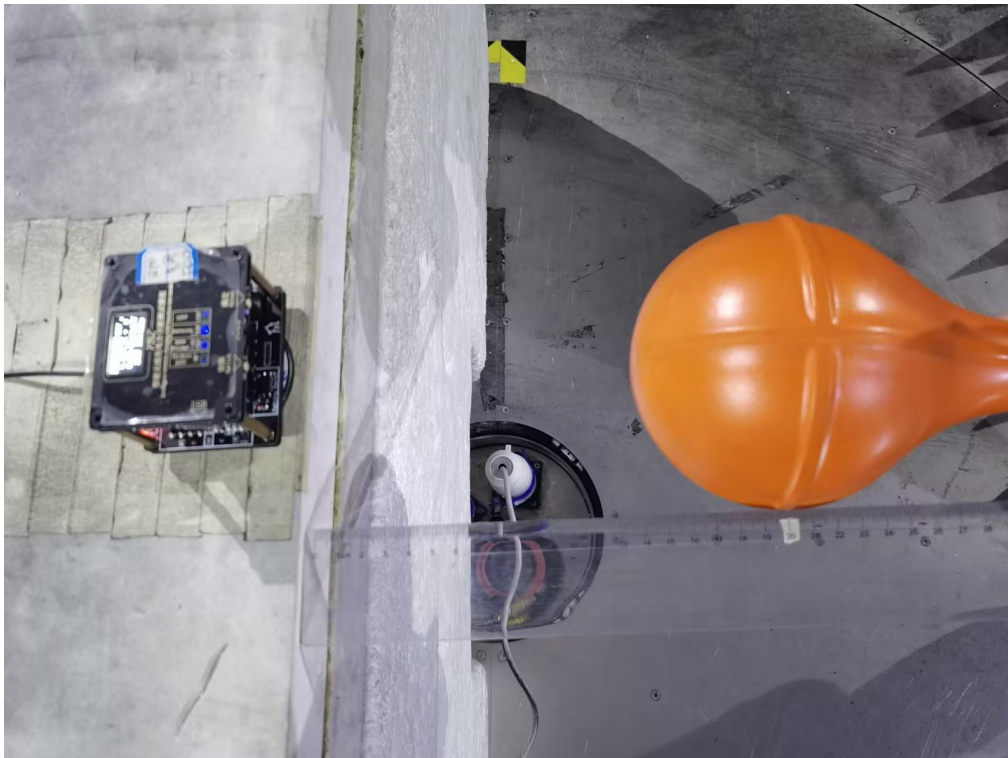

Any report having not been signed by authorized approver, or having been altered without authorization, or having not been stamped by the “Dedicated Testing/Inspection Stamp” is deemed to be invalid. Copying or excerpting portion of, or altering the content of the report is not permitted without the written authorization of AGC. The test results presented in the report apply only to the tested sample. Any objections to report issued by AGC should be submitted to AGC within 15days after the issuance of the test report. Further enquiry of validity or verification of the test report should be addressed to AGC by agc01@agccert.com.

WPT Equipment Position D

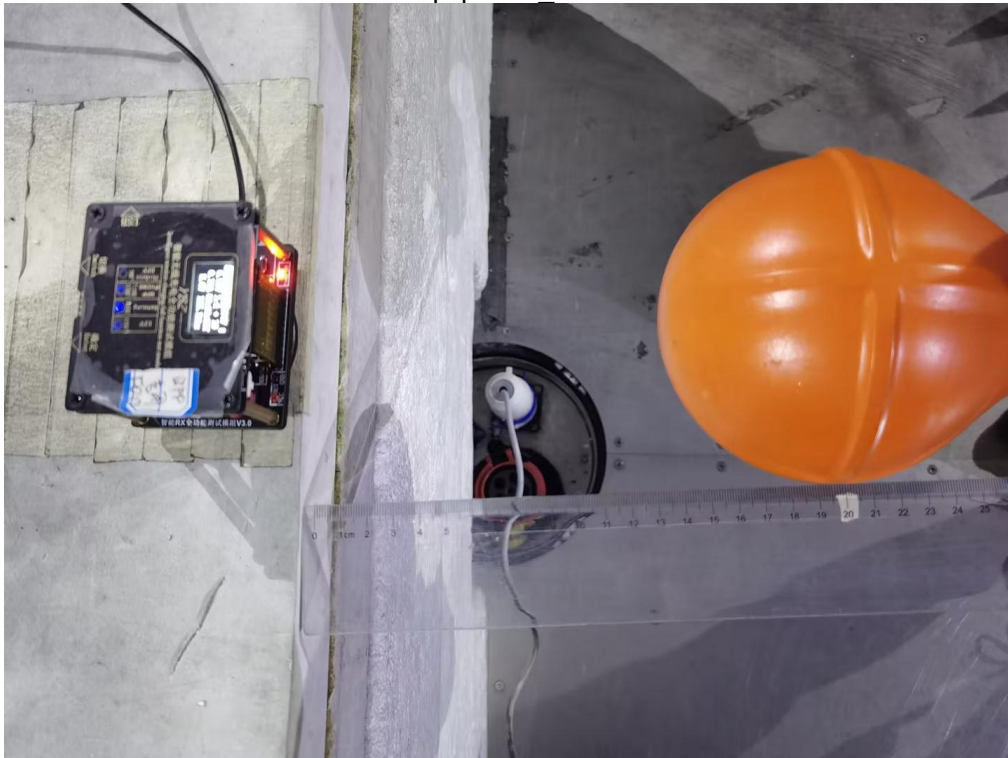

----END OF REPORT----

Any report having not been signed by authorized approver, or having been altered without authorization, or having not been stamped by the “Dedicated Testing/Inspection Stamp” is deemed to be invalid. Copying or excerpting portion of, or altering the content of the report is not permitted without the written authorization of AGC. The test results presented in the report apply only to the tested sample. Any objections to report issued by AGC should be submitted to AGC within 15days after the issuance of the test report. Further enquiry of validity or verification of the test report should be addressed to AGC by agc01@agccert.com.



## Conditions of Issuance of Test Reports

1. All samples and goods are accepted by the Attestation of Global Compliance (Shenzhen) Co., Ltd (the “Company”) solely for testing and reporting in accordance with the following terms and conditions. The company provides its services on the basis that such terms and conditions constitute express agreement between the company and any person, firm or company requesting its services (the “Clients”).
2. Any report issued by Company as a result of this application for testing services (the “Report”) shall be issued in confidence to the Clients and the Report will be strictly treated as such by the Company. It may not be reproduced either in its entirety or in part and it may not be used for advertising or other unauthorized purposes without the written consent of the Company. The Clients to whom the Report is issued may, however, show or send it, or a certified copy thereof prepared by the Company to its customer, supplier or other persons directly concerned. The Company will not, without the consent of the Clients, enter into any discussion or correspondence with any third party concerning the contents of the Report, unless required by the relevant governmental authorities, laws or court orders.
3. The Company shall not be called or be liable to be called to give evidence or testimony on the Report in a court of law without its prior written consent, unless required by the relevant governmental authorities, laws or court orders.
4. In the event of the improper use of the report as determined by the Company, the Company reserves the right to withdraw it, and to adopt any other additional remedies which may be appropriate.
5. Samples submitted for testing are accepted on the understanding that the Report issued cannot form the basis of, or be the instrument for, any legal action against the Company.
6. The Company will not be liable for or accept responsibility for any loss or damage however arising from the use of information contained in any of its Reports or in any communication whatsoever about its said tests or investigations.
7. Clients wishing to use the Report in court proceedings or arbitration shall inform the Company to that effect prior to submitting the sample for testing.
8. The Company is not responsible for recalling the electronic version of the original report when any revision is made to them. The Client assumes the responsibility to providing the revised version to any interested party who uses them.
9. Subject to the variable length of retention time for test data and report stored hereinto as otherwise specifically required by individual accreditation authorities, the Company will only keep the supporting test data and information of the test report for a period of six years. The data and information will be disposed of after the aforementioned retention period has elapsed. Under no circumstances shall we provide any data and information which has been disposed of after retention period. Under no circumstances shall we be liable for damage of any kind, including (but not limited to) compensatory damages, lost profits, lost data, or any form of special, incidental, indirect, consequential or punitive damages of any kind, whether based on breach of contract of warranty, tort (including negligence), product liability or otherwise, even if we are informed in advance of the possibility of such damages.

Any report having not been signed by authorized approver, or having been altered without authorization, or having not been stamped by the “Dedicated Testing/Inspection Stamp” is deemed to be invalid. Copying or excerpting portion of, or altering the content of the report is not permitted without the written authorization of AGC. The test results presented in the report apply only to the tested sample. Any objections to report issued by AGC should be submitted to AGC within 15 days after the issuance of the test report. Further enquiry of validity or verification of the test report should be addressed to AGC by [agc01@agccert.com](mailto:agc01@agccert.com).