



中国认可
国际互认
检测
TESTING
CNAS L6478



TEST REPORT

Reference No...... : WTF24F05107651W001
Applicant..... : Mid Ocean Brands B.V.
Address..... : 7/F., Kings Tower, 111 King Lam Street, Cheung Sha Wan, Kowloon, Hong Kong
Manufacturer : 117486
Address..... : ---
Product Name..... : Wireless multi 4 in 1 speaker
Model No...... : MO2378
Test specification..... : ETSI EN 300 328 V2.2.2 (2019-07)
Date of Receipt sample : 2024-05-30
Date of Test : 2024-07-01 to 2024-07-02
Date of Issue..... : 2024-07-09
Test Report Form No. : WEW-300328A-01B
Test Result..... : **Pass**

Remarks:

The results shown in this test report refer only to the sample(s) tested, this test report cannot be reproduced, except in full, without prior written permission of the company. The report would be invalid without specific stamp of test institute and the signatures of approver.

Prepared By:

Waltek Testing Group (Foshan) Co., Ltd.

Address: 1/F., Building 19, Sunlink Machinery City, Xingye 4 Road,
Guanglong Industrial Park, Chihua Neighborhood Committee, Chencun Town,
Shunde District, Foshan, Guangdong, China

Tel:+86-757-23811398 Fax:+86-757-23811381 E-mail:info@waltek.com.cn

Tested by:

Roy Hong

Approved by:

Danny Zhou



1 Test Summary

Radio Spectrum			
Test	Test Requirement	Limit / Severity	Result
RF output power	ETSI EN 300 328 V2.2.2	≤20dBm	Pass
Duty Cycle, Tx-sequence, Tx-gap	ETSI EN 300 328 V2.2.2	-	N/A
Accumulated Transmit Time, Frequency Occupation and Hopping Sequence	ETSI EN 300 328 V2.2.2	Clause 4.3.1.4.3	Pass
Hopping Frequency Separation	ETSI EN 300 328 V2.2.2	≥100kHz	Pass
Medium Utilization	ETSI EN 300 328 V2.2.2	-	N/A
Adaptivity (Adaptive Frequency Hopping)	ETSI EN 300 328 V2.2.2	-	N/A
Occupied Channel Bandwidth	ETSI EN 300 328 V2.2.2	Within the band 2400-2483.5MHz	Pass
Transmitter unwanted in the OOB domain	ETSI EN 300 328 V2.2.2	Figure 1	Pass
Transmitter unwanted emissions in the spurious domain	ETSI EN 300 328 V2.2.2	Table 4	Pass
Receiver spurious emissions	ETSI EN 300 328 V2.2.2	Table 5	Pass
Receiver Blocking	ETSI EN 300 328 V2.2.2	Clause 4.3.1.12.4	Pass

Remark:

Pass Test item meets the requirement

N/A Not Applicable



2 Contents

	Page
1 TEST SUMMARY	2
2 CONTENTS	3
3 GENERAL INFORMATION	4
3.1 GENERAL DESCRIPTION OF E.U.T.	4
3.2 TECHNICAL SPECIFICATION	4
3.3 STANDARDS APPLICABLE FOR TESTING	5
3.4 TEST FACILITY.....	5
3.5 SUBCONTRACTED.....	5
3.6 ABNORMALITIES FROM STANDARD CONDITIONS	5
3.7 DISCLAIMER	5
4 EQUIPMENT USED DURING TEST	6
4.1 EQUIPMENT LIST	6
4.2 SOFTWARE LIST.....	7
4.3 SPECIAL ACCESSORIES AND AUXILIARY EQUIPMENT	7
4.4 MEASUREMENT UNCERTAINTY	7
4.5 DECISION RULE	7
5 TEST CONDITIONS AND TEST MODE	8
6 RF REQUIREMENTS	9
6.1 RF OUTPUT POWER	9
6.2 ACCUMULATED TRANSMIT TIME, MINIMUM FREQUENCY OCCUPATION AND HOPPING SEQUENCE	15
6.3 HOPPING FREQUENCY SEPARATION.....	26
6.4 OCCUPIED CHANNEL BANDWIDTH.....	29
6.5 TRANSMITTER UNWANTED EMISSIONS IN THE OUT-OF-BAND DOMAIN.....	33
6.6 TRANSMITTER UNWANTED EMISSIONS IN THE SPURIOUS DOMAIN	39
6.7 RECEIVER SPURIOUS EMISSIONS	41
6.8 RECEIVER BLOCKING.....	42
7 PHOTOGRAPHS – TEST SETUP	47
7.1 PHOTOGRAPH – SPURIOUS EMISSIONS TEST SETUP	47
8 PHOTOGRAPHS – EUT CONSTRUCTIONAL DETAILS	48



3 General Information

3.1 General Description of E.U.T.

Product Name : Wireless multi 4 in 1 speaker
Model No. : MO2378
Remark : ---
Rating : Type-C Input: DC 5V, 3A or DC 9V, 3A
 Wireless output: 15W Max.
Battery Capacity : 1200mAh
Adapter Model..... : ---

3.2 Technical Specification

Bluetooth Version : Bluetooth V5.3 (BR+EDR)
Frequency Range : 2402-2480MHz
Maximum RF Output Power : -2.41 dBm (EIRP)
Type of Modulation : GFSK, $\pi/4$ QPSK, 8DPSK
Data Rate : 1Mbps, 2Mbps, 3Mbps
Quantity of Channels : 79
Channel Separation..... : 1MHz
Antenna Type..... : PCB Antenna
Antenna Gain : 0dBi
Receiver Category : 3

Receiver Category	Description
1	Adaptive equipment with a maximum RF output power greater than 10 dBm e.i.r.p.
2	non-adaptive equipment with a Medium Utilization (MU) factor greater than 1 % and less than or equal to 10 % (irrespective of the maximum RF output power); or equipment (adaptive or non-adaptive) with a maximum RF output power greater than 0 dBm e.i.r.p. and less than or equal to 10 dBm e.i.r.p.
3	non-adaptive equipment with a maximum Medium Utilization (MU) factor of 1 % (irrespective of the maximum RF output power) or equipment (adaptive or non-adaptive) with a maximum RF output power of 0 dBm e.i.r.p.



3.3 Standards Applicable for Testing

The tests were performed according to following standards:

ETSI EN 300 328 V2.2.2 (2019-07) Electromagnetic compatibility and Radio spectrum Matters (ERM); Wideband transmission systems; Data transmission equipment operating in the 2,4 GHz ISM band and using wide band modulation techniques; Harmonized EN covering essential requirements under article 3.2 of the RED Directive.

3.4 Test Facility

The test facility has a test site registered with the following organizations:

- **ISED – Registration No.: 21895**

Waltek Testing Group (Foshan) Co., Ltd. has been registered and fully described in a report filed with the Innovation, Science and Economic Development Canada (ISED). The acceptance letter from the ISED is maintained in our files. Registration ISED number: 21895, March 12, 2019

- **FCC – Registration No.: 820106**

Waltek Testing Group (Foshan) Co., Ltd. EMC Laboratory has been registered and fully described in a report filed with the (FCC) Federal Communications Commission. The acceptance letter from the FCC is maintained in our files. Registration 820106, August 16, 2018

- **NVLAP – Lab Code: 600191-0**

Waltek Testing Group (Foshan) Co., Ltd. EMC Laboratory is accredited by the National Voluntary Laboratory Accreditation Program (NVLAP/NIST). NVLAP Code: 600191-0.

This report must not be used by the client to claim product certification, approval, or endorsement by NVLAP, NIST, or any agency of the Federal Government.

3.5 Subcontracted

Whether parts of tests for the product have been subcontracted to other labs:

Yes No

If Yes, list the related test items and lab information:

Test items:---

Lab information:---

3.6 Abnormalities from Standard Conditions

None.

3.7 Disclaimer

The antenna gain information is provided by the customer. The laboratory is not responsible for the accuracy of the antenna gain information.



4 Equipment Used during Test

4.1 Equipment List

<input checked="" type="checkbox"/> 3m Semi-anechoic Chamber for Spurious Emission						
Item	Equipment	Manufacturer	Model No.	Serial No.	Last Calibration Date	Calibration Due Date
1	3m Semi-anechoic Chamber	CHANGCHUANG	9m×6m×6m	-	2024-01-05	2025-01-04
2	EMI TEST RECEIVER	RS	ESR7	101566	2024-01-06	2025-01-05
3	Spectrum Analyzer	Agilent	N9020A	MY48011796	2024-01-04	2025-01-03
4	Trilog Broadband Antenna	SCHWARZBECK	VULB9162	9162-117	2024-01-05	2025-01-04
5	Coaxial Cable (below 1GHz)	H+S	CBL3-NN-12+3 m	214NN320	2024-01-06	2025-01-05
6	Broad-band Horn Antenna	SCHWARZBECK	BBHA 9120 D	01561	2024-01-05	2025-01-04
7	Broadband Preamplifier (Above 1GHz)	Lunar E M	LNA1G18-40	20160501002	2024-01-04	2025-01-03
8	Coaxial Cable (above 1GHz)	Times-Microwave	CBL5-NN	-	2024-01-04	2025-01-03
<input checked="" type="checkbox"/> RF Conducted test						
Item	Equipment	Manufacturer	Model No.	Serial No.	Last Calibration Date	Calibration Due Date
1	Environmental Chamber	KSON	THS-D4C-100	5244K	2024-01-17	2025-01-16
2	Spectrum Analyzer	Agilent	N9020A	MY48011796	2024-01-04	2025-01-03
3	EXG Analog Signal Generator	Agilent	N5181A	MY48180720	2024-01-04	2025-01-03
4	RF Control Unit	CHANGCHUANG	JS0806-2	-	2024-01-04	2025-01-03
5	Wideband radio communication tester	Rohde&Schwarz	CMW500	1201.0002K50-158178-Qf	2024-01-04	2025-01-03
6	USB Wideband Power Sensor	KEYSIGHT	U2021XA	MY56510008	2024-01-04	2025-01-03

: Not Used

: Used



4.2 Software List

Description	Manufacturer	Model	Version
EMI Test Software (Radiated Emission)	FARATRONIC	EZ-EMC	RA-03A1-1
RF Conducted Test	TONSCEND	JS1120-2	2.6

4.3 Special Accessories and Auxiliary Equipment

Item	Equipment	Technical Data	Manufacturer	Model No.	Serial No.
1.	/	/	/	/	/

4.4 Measurement Uncertainty

Parameter	Uncertainty	Note
RF Output Power	±2.2dB	(1)
Occupied Bandwidth	±1.5%	(1)
Transmitter Spurious Emission	±3.8dB (for 25MHz-1GHz)	(1)
	±5.0dB (for 1GHz-18GHz)	(1)

(1) This uncertainty represents an expanded uncertainty expressed at approximately the 95% confidence level using a coverage factor of $k=2$.

4.5 Decision Rule

Compliance or non-compliance with a disturbance limit shall be determined in the following manner.

If U_{LAB} is less than or equal to U_{cispr} , then

- Compliance is deemed to occur if no measured disturbance level exceeds the disturbance limit;
- Non-compliance is deemed to occur if any measured disturbance level exceeds the disturbance limit.

If U_{LAB} is greater than U_{cispr} , then

- Compliance is deemed to occur if no measured disturbance level, increased by $(U_{LAB} - U_{cispr})$, exceeds the disturbance limit;
- Non-compliance is deemed to occur if any measured disturbance level, increased by $(U_{LAB} - U_{cispr})$, exceeds the disturbance limit.



5 Test Conditions and Test mode

The equipment under test (EUT) was configured to measure its highest possible emission/immunity level. The test modes were adapted according to the operation manual for use, the EUT was operated in the continuous transmitting mode that was for the purpose of the measurements, more detailed description as follows:

Test Mode List		
Test Mode	Description	Remark
TM1	Low	2402MHz
TM2	Middle	2441MHz
TM3	High	2480MHz
TM4	Hopping	2402-2480MHz

Modulation Configure	
Modulation	Packet
GFSK	DH1
	DH3
	DH5
$\pi/4$ QPSK	2DH1
	2DH3
	2DH5
8DPSK	3DH1
	3DH3
	3DH5

Test Conditions			
	Normal	LTNV	HTNV
Temperature (°C)	22	-10	+50
Voltage (Vdc)	3.7		
Relative Humidity:	45 %		
ATM Pressure:	101.2kPa		



6 RF Requirements

6.1 RF Output power

6.1.1 Standard Applicable

According to Section 4.3.1.2.3, The RF output power for FHSS equipment shall be equal to or less than 20 dBm.

For non-adaptive FHSS equipment, where the manufacturer has declared an RF output power lower than 20 dBm e.i.r.p., the RF output power shall be equal to or less than that declared value.

This limit shall apply for any combination of power level and intended antenna assembly.

The measurements for RF output power shall be performed at both normal environmental conditions and at the extremes of the operating temperature range.

6.1.2 Test Procedure

According to section 5.4.2.2.1.2 of the standard ETSI EN 300328, the test procedure shall be as follows:

Step 1:

- Use a fast power sensor suitable for 2,4 GHz and capable of 1 MS/s.
- Use the following settings: - Sample speed 1 MS/s or faster.
- The samples must represent the power of the signal.
- Measurement duration: For non-adaptive equipment: equal to the observation period defined in clauses 4.3.1.2.1 or 4.3.2.3.1. For adaptive equipment, the measurement duration shall be long enough to ensure a minimum number of bursts (at least 10) are captured.

NOTE 1: For adaptive equipment, to increase the measurement accuracy, a higher number of bursts may be used.

Step 2:

- For conducted measurements on devices with one transmit chain:
 - Connect the power sensor to the transmit port, sample the transmit signal and store the raw data. Use these stored samples in all following steps.
- For conducted measurements on devices with multiple transmit chains:
 - Connect one power sensor to each transmit port for a synchronous measurement on all transmit ports.
 - Trigger the power sensors so that they start sampling at the same time. Make sure the time difference between the samples of all sensors is less than half the time between two samples.
 - For each individual sampling point (time domain), sum the coincident power samples of all ports and store them.

Use these summed samples in all following steps..

**Step 3:**

- Find the start and stop times of each burst in the stored measurement samples.

The start and stop times are defined as the points where the power is at least 30 dB below the highest value of the stored samples in step 2.

NOTE 2: In case of insufficient dynamic range, the value of 30 dB may need to be reduced appropriately.

Step 4:

- Between the start and stop times of each individual burst calculate the RMS power over the burst using the formula below. Save these Pburst values, as well as the start and stop times for each burst.

$$P_{burst} = \frac{1}{k} \sum_{n=1}^k P_{sample}(n)$$

with 'k' being the total number of samples and 'n' the actual sample number

Step 5:

- The highest of all Pburst values (value "A" in dBm) will be used for maximum e.i.r.p. calculations.

Step 6:

- Add the (stated) antenna assembly gain "G" in dBi of the individual antenna.
- If applicable, add the additional beamforming gain "Y" in dB.
- If more than one antenna assembly is intended for this power setting, the maximum overall antenna gain (G or G + Y) shall be used.
- The RF Output Power (P) shall be calculated using the formula below: $P = A + G + Y$
- This value, which shall comply with the limit given in clause 4.3.1.2.3 or clause 4.3.2.2.3, shall be recorded in the test report.



6.1.3 Test Result

Modulation Type	Test Condition	Test Mode	Channel	EIRP (dBm)	Limit (dBm)	Verdict
GFSK	TLVN	DH5	Hop	-5.04	20	Pass
	TNVN	DH5	Hop	-5.19	20	Pass
	THVN	DH5	Hop	-4.77	20	Pass
$\pi/4$ QPSK	TLVN	2DH5	Hop	-4.58	20	Pass
	TNVN	2DH5	Hop	-4.24	20	Pass
	THVN	2DH5	Hop	-4.24	20	Pass
8DPSK	TLVN	3DH5	Hop	-2.41	20	Pass
	TNVN	3DH5	Hop	-3.04	20	Pass
	THVN	3DH5	Hop	-2.75	20	Pass

Remark: EIRP=Conducted power+ ANT gain

WALTEK



Test Graphs:

RF Output Power_TLVN_DH5

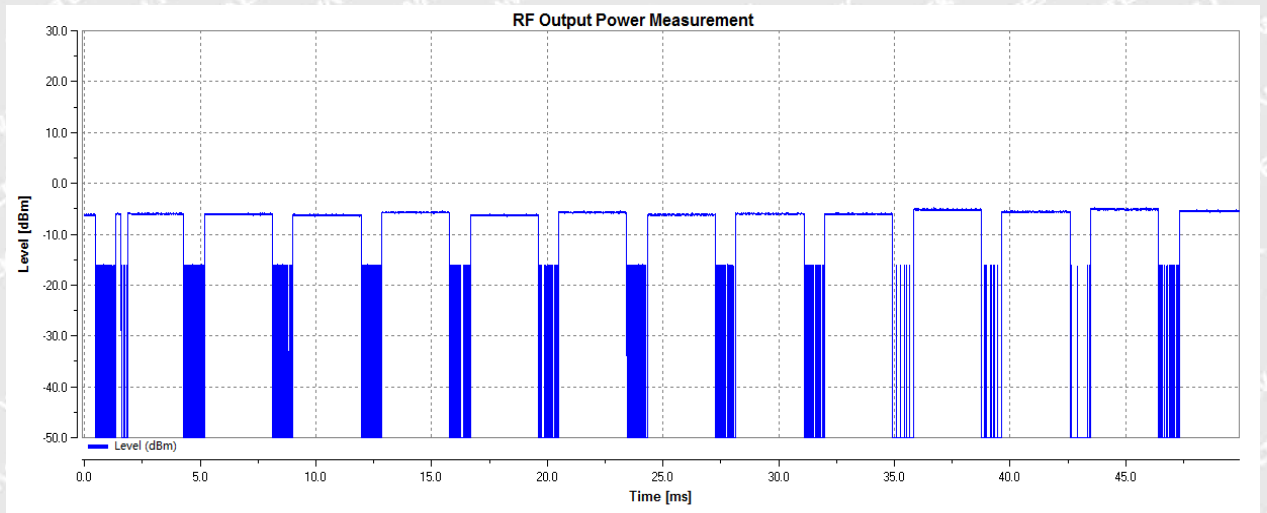

RF Output Power_TNVN_DH5

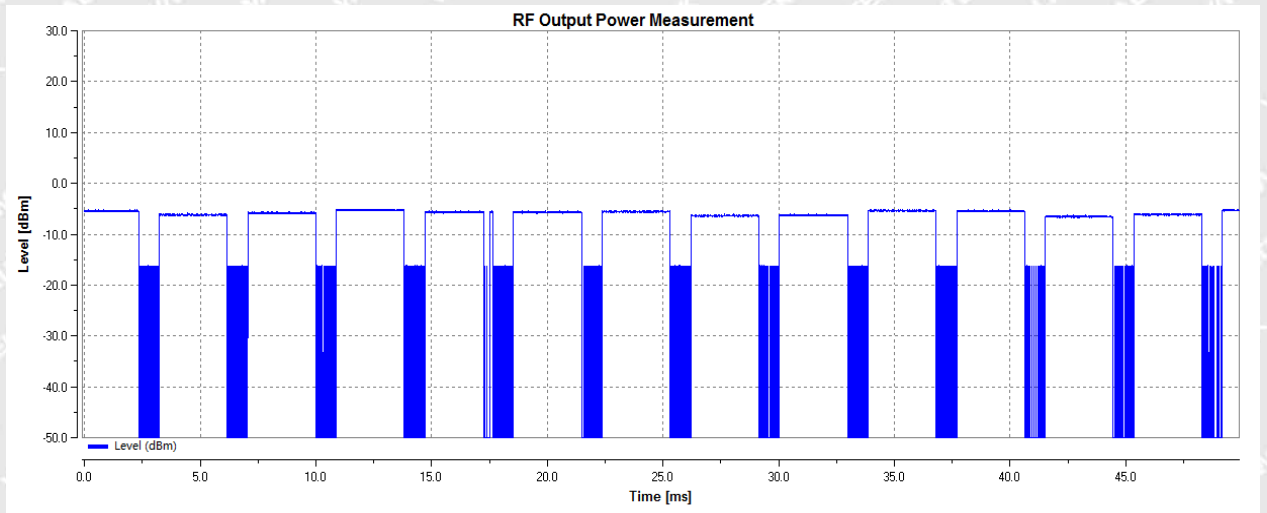

RF Output Power_THVN_DH5

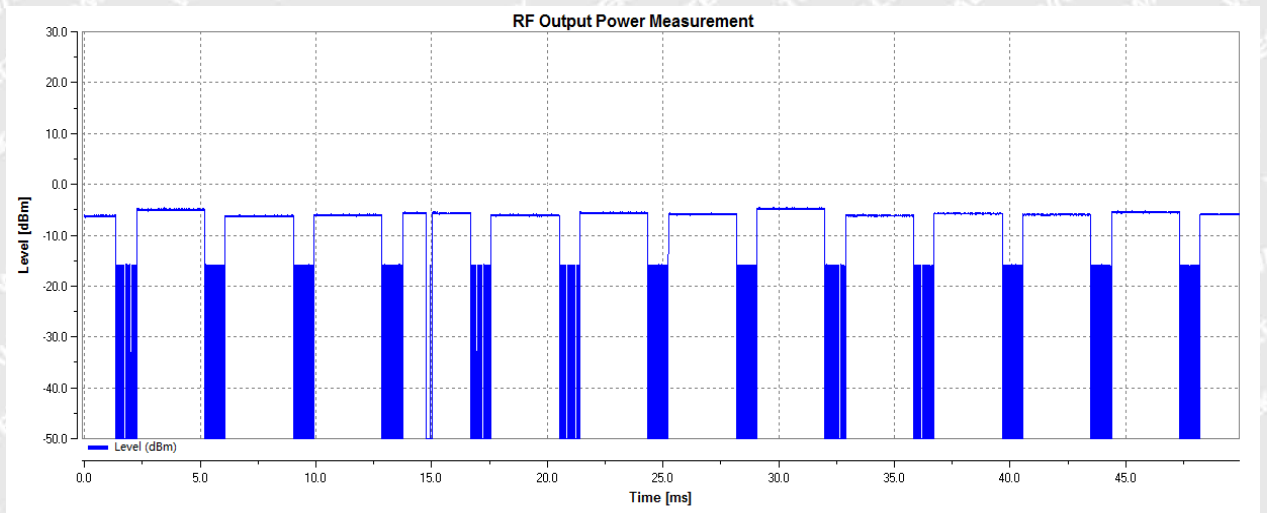



RF Output Power_TLVN_2DH5

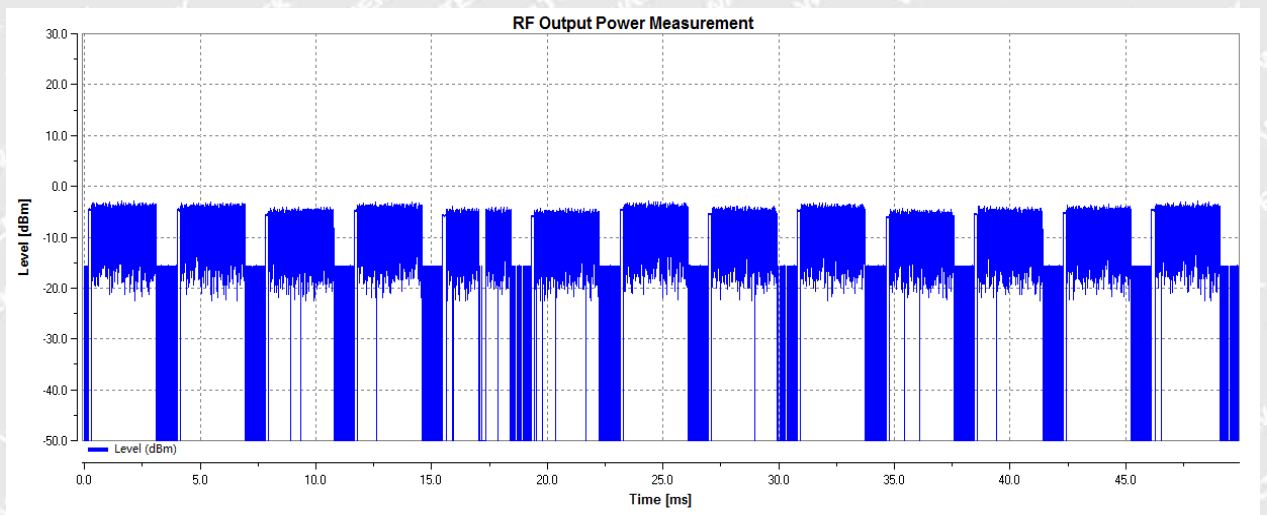

RF Output Power_TNVN_2DH5

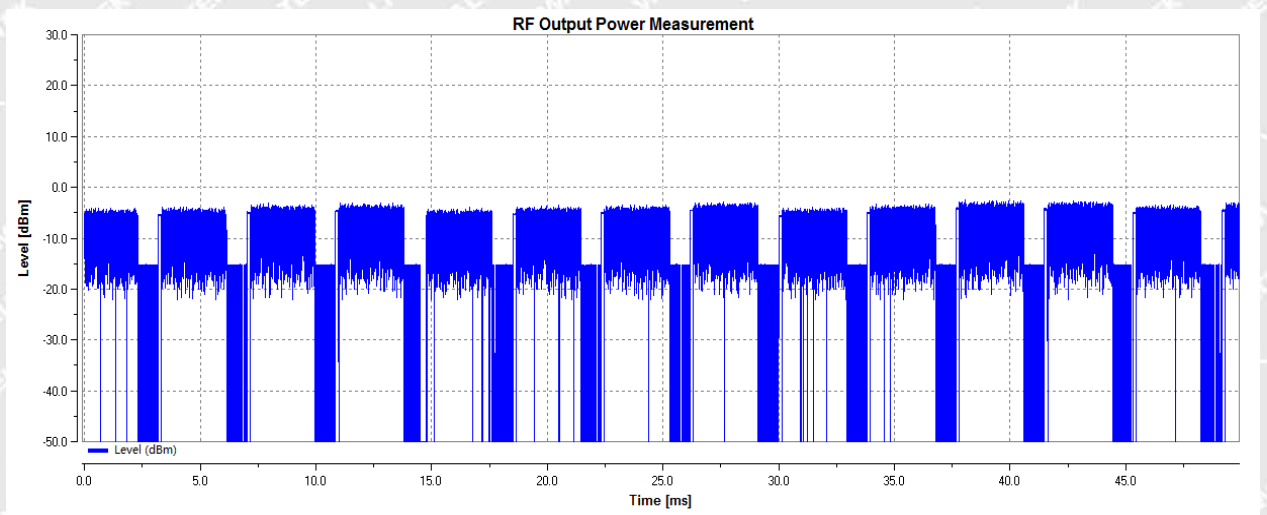

RF Output Power_THVN_2DH5

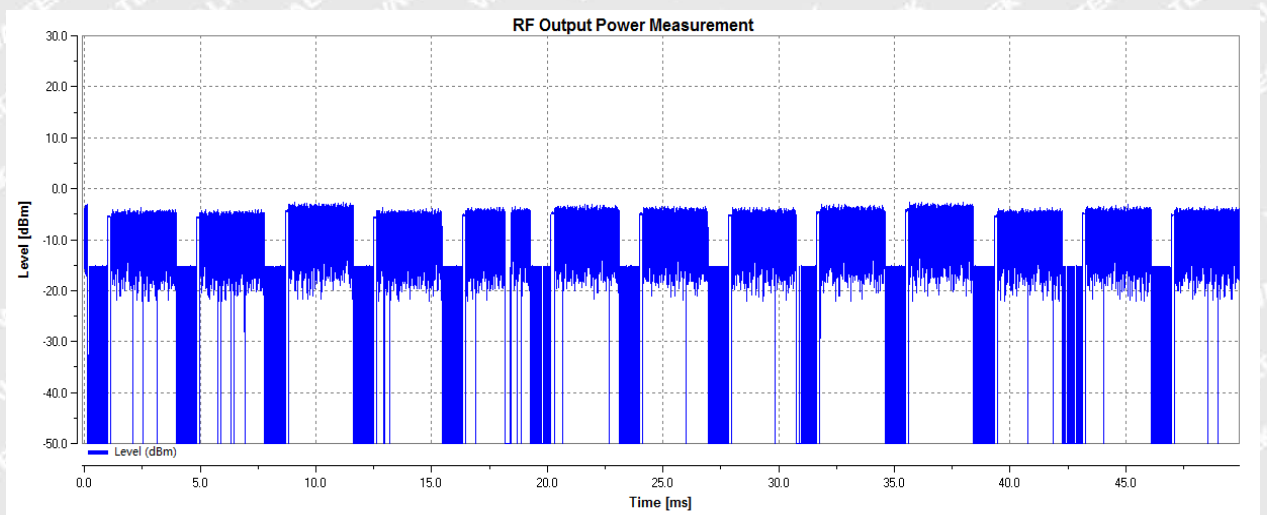



RF Output Power_TLVN_3DH5

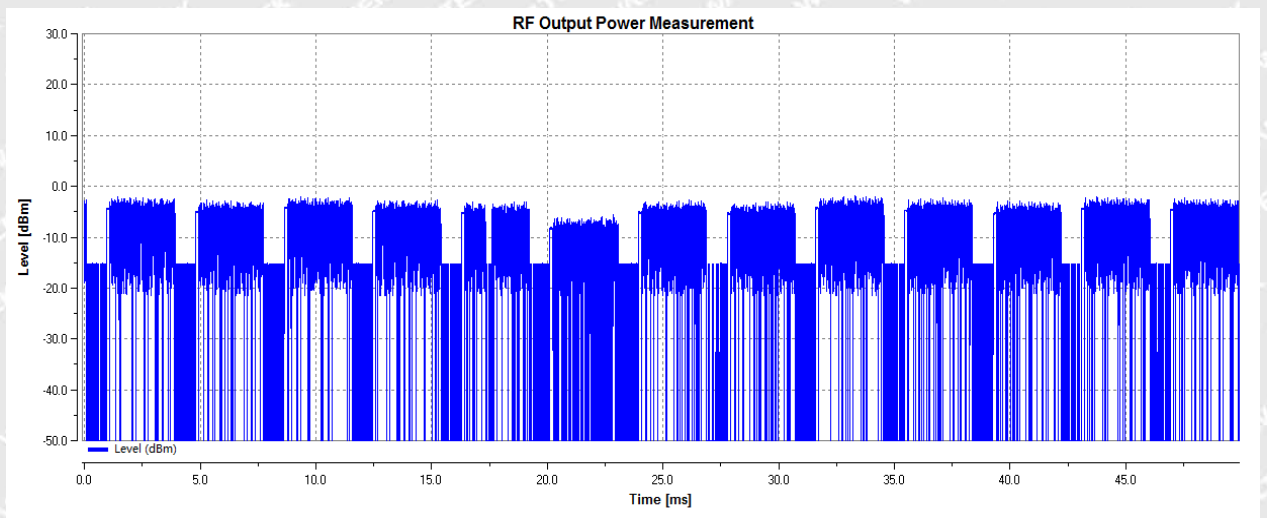

RF Output Power_TNVN_3DH5

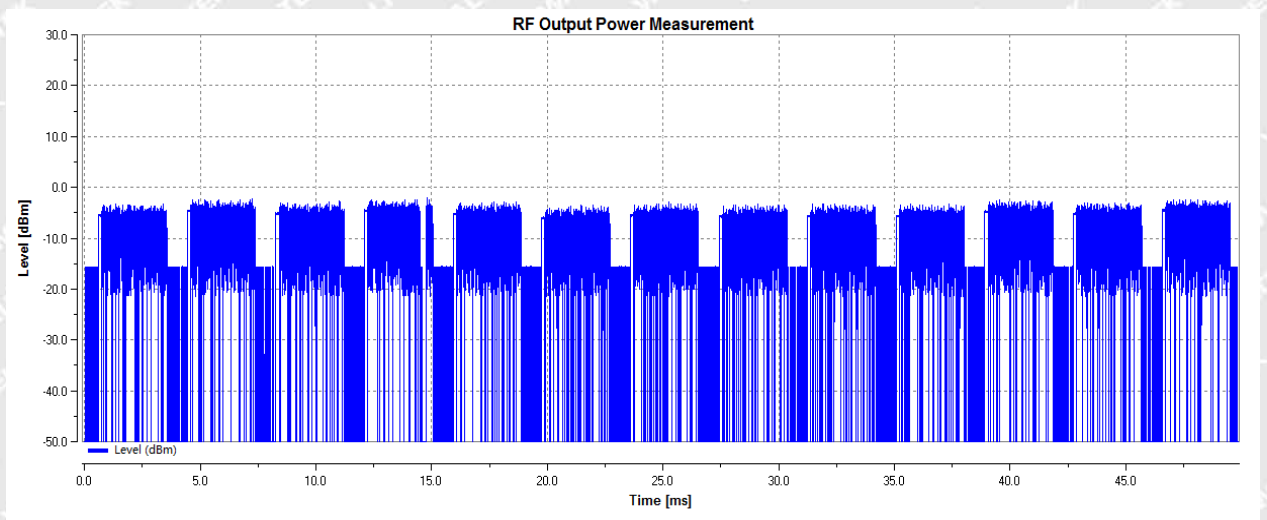

RF Output Power_THVN_3DH5

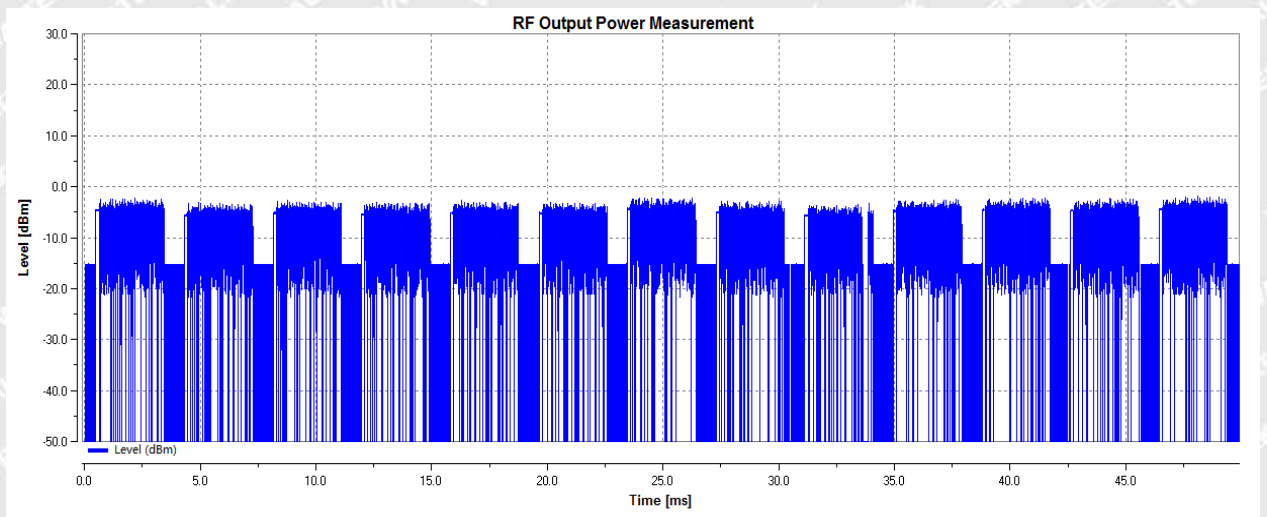

Remark: The antenna gain is not considered in the result plot.



6.2 Accumulated Transmit Time, Minimum Frequency Occupation and Hopping Sequence

6.2.1 Standard Applicable

According to section 4.3.1.4.3, adaptive FHSS equipment shall be capable of operating over a minimum of 70 % of the band specified in table 1.

The Accumulated Transmit Time on any hopping frequency shall not be greater than 400 ms within any observation period of 400 ms multiplied by the minimum number of hopping frequencies (N) that have to be used.

In order for the FHSS equipment to comply with the Frequency Occupation requirement, it shall meet either of the following two options:

Option 1: Each hopping frequency of the Hopping Sequence shall be occupied at least once within a period not exceeding four times the product of the dwell time and the number of hopping frequencies in use.

Option 2: The occupation probability for each frequency shall be between $((1 / U) \times 25 \%)$ and 77 % where U is the number of hopping frequencies in use.

The Hopping Sequence(s) shall contain at least N hopping frequencies at all times, where N is either 15 or the result of 15 MHz divided by the minimum Hopping Frequency Separation in MHz, whichever is the greater.

For Adaptive FHSS equipment, from the N hopping frequencies defined above, the equipment shall consider at least one hopping frequency for its transmissions. Providing that there is no interference present on this hopping frequency with a level above the detection threshold defined in clause 4.3.1.7.2.2, point 5 or clause 4.3.1.7.3.2, point 5, then the equipment shall have transmissions on this hopping frequency. For Adaptive FHSS equipment using LBT, if a signal is detected during the CCA, the equipment may jump immediately to the next hopping frequency in the Hopping Sequence (see clause 4.3.1.7.2.2, point 2) provided the limit for Accumulated Transmit Time on the new hopping frequency is respected.

These measurements shall only be performed at normal test conditions.



6.2.2 Test Procedure

According to section 5.4.4.2.1 of the standard ETSI EN 300328, the test procedure shall be as follows:

Step 1:

- The output of the transmitter shall be connected to a spectrum analyser or equivalent.
- The analyser shall be set as follows:
 - Centre Frequency: Equal to the hopping frequency being investigated
 - Frequency Span: 0 Hz
 - RBW: ~ 50 % of the Occupied Channel Bandwidth
 - VBW: \geq RBW
 - Detector Mode: RMS
 - Sweep time: Equal to the applicable observation period (see clause 4.3.1.4.3.1 or clause 4.3.1.4.3.2)
 - Number of sweep points: 30 000
 - Trace mode: Clear/Write
 - Trigger: Free Run

Step 2:

- Save the trace data to a file for further analysis by a computing device using an appropriate software application or program.

Step 3:

- Identify the data points related to the frequency being investigated by applying a threshold.

The data points resulting from transmissions on the hopping frequency being investigated are assumed to have much higher levels compared to data points resulting from transmissions on adjacent hopping frequencies. If a clear determination between these transmissions is not possible, the RBW in step 1 shall be further reduced. In addition, a channel filter may be used.

- Count the number of data points identified as resulting from transmissions on the frequency being investigated and multiply this number by the time difference between two consecutive data points.

Step 4:

- The result in step 3 is the Accumulated Transmit Time which shall comply with the limit provided in clause 4.3.1.4.3.1 or clause 4.3.1.4.3.2 and which shall be recorded in the test report.

Step 5:

This step is only applicable for equipment implementing Option 1 in clause 4.3.1.4.3.1 or Option 1 in clause 4.3.1.4.3.2 for complying with the Frequency Occupation requirement.

- Make the following changes on the analyser and repeat step 2 and step 3.

Sweep time: $4 \times \text{dwell time} \times \text{Actual number of hopping frequencies in use}$.

The hopping frequencies occupied by the equipment without having transmissions during the dwell time (blacklisted frequencies) should be taken into account in the actual number of hopping frequencies in use. If this number cannot be determined (number of blacklisted frequencies unknown) it shall be assumed that the equipment uses the maximum possible number of hopping frequencies.



- The result shall be compared to the limit for the Frequency Occupation defined in clause 4.3.1.4.3.1, Option 1 or clause 4.3.1.4.3.2, Option 1. The result of this comparison shall be recorded in the test report.

Step 6:

- Make the following changes on the analyser:
 - Start Frequency: 2 400 MHz
 - Stop Frequency: 2 483,5 MHz
 - RBW: ~ 50 % of the Occupied Channel Bandwidth (single hopping frequency)
 - VBW: \geq RBW
 - Detector Mode: Peak
 - Sweep time: 1 s; this setting may result in long measuring times. To avoid such long measuring times, an FFT analyser may be used
 - Number of sweep points: ~ 400 / Occupied Channel Bandwidth (MHz); the number of sweep points may need to be further increased in case of overlapping channels
 - Trace Mode: Max Hold
 - Trigger: Free Run
- Wait for the trace to stabilize. Identify the number of hopping frequencies used by the Hopping Sequence.
- The result shall be compared to the limit (value N) defined in clause 4.3.1.4.3.1 or clause 4.3.1.4.3.2. This value shall be recorded in the test report.

For equipment with blacklisted frequencies, it might not be possible to verify the number of hopping frequencies in use. However, they shall comply with the requirement for Accumulated Transmit Time and Frequency Occupation assuming the minimum number of hopping frequencies (N) defined in clause 4.3.1.4.3.1 or clause 4.3.1.4.3.2 is used.

Step 7:

- For adaptive FHSS equipment, it shall be verified whether the equipment uses 70 % of the band specified in table 1. This verification can be done using the lowest and highest -20 dB points from the total spectrum envelope obtained in step 6. The result shall be recorded in the test report.



6.2.3 Test Result

Maximum Accumulated Dwell Time					
Modulation	Test Channel	Packet	Acc. Dwell Time (ms)	Limit (ms)	Verdict
GFSK	2402MHz	DH5	383.425	400	Pass
	2480MHz	DH5	398.172	400	Pass
π/4QPSK	2402MHz	2DH5	362.358	400	Pass
	2480MHz	2DH5	361.304	400	Pass
8DPSK	2402MHz	3DH5	395.012	400	Pass
	2480MHz	3DH5	383.425	400	Pass

Test Period: 400ms X Minimum number of hopping frequencis (N)

Accumulated Dwell Time = Time slot length (Dwell time) X Number of data points within a test period

Test Graphs:

Accumulated Dwell Time_DH5_2402

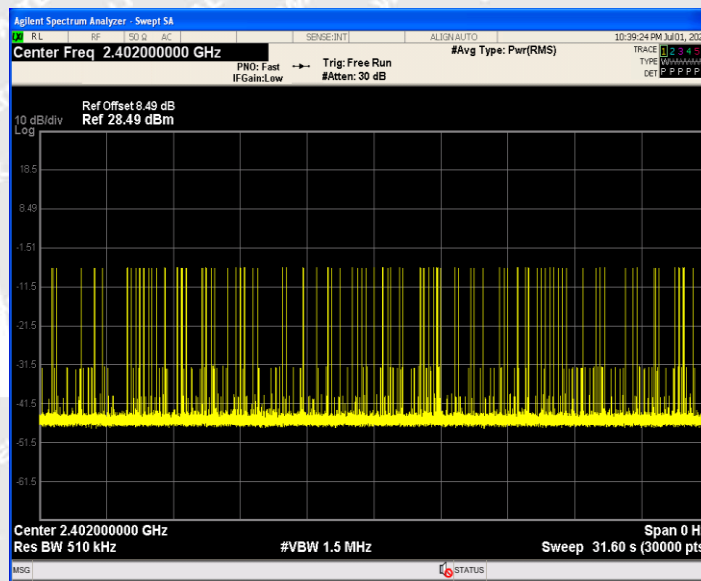

Accumulated Dwell Time_DH5_2480

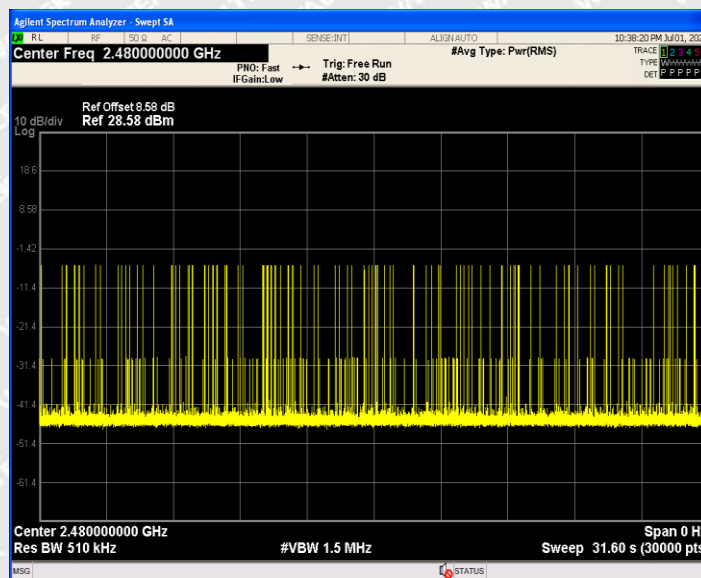



Accumulated Dwell Time_2DH5_2402

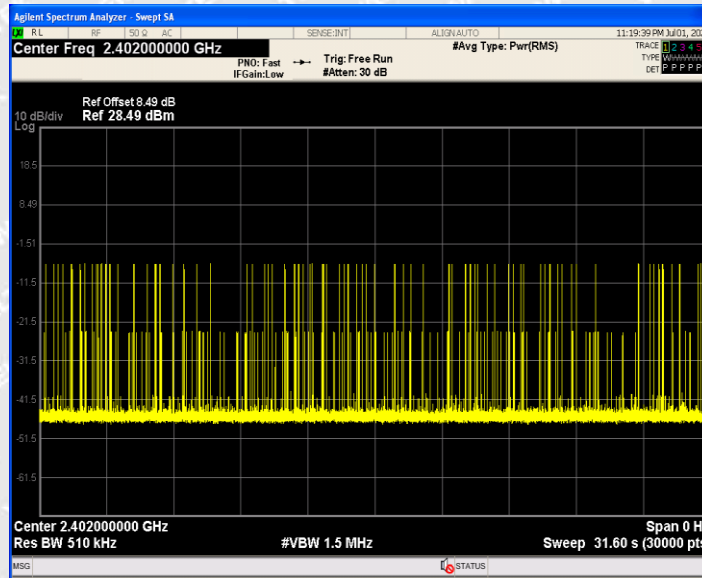

Accumulated Dwell Time_2DH5_2480

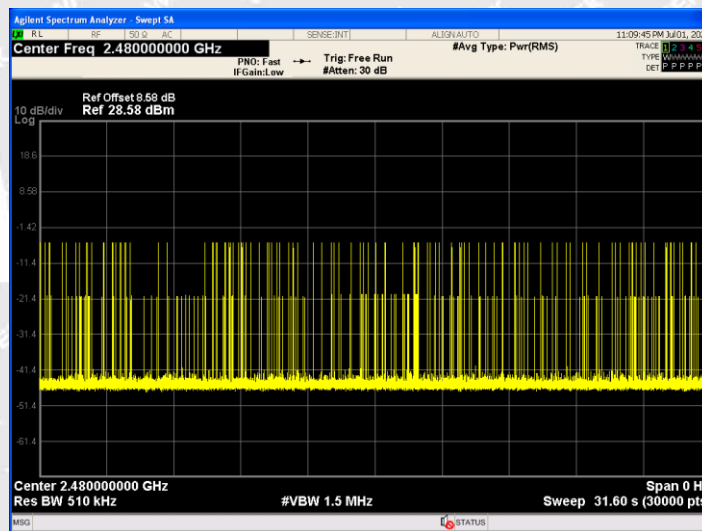



Accumulated Dwell Time_3DH5_2402

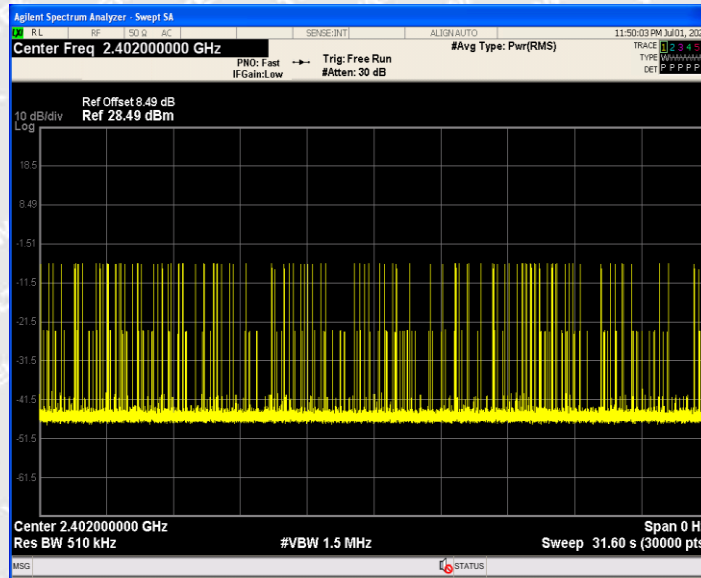

Accumulated Dwell Time_3DH5_2480

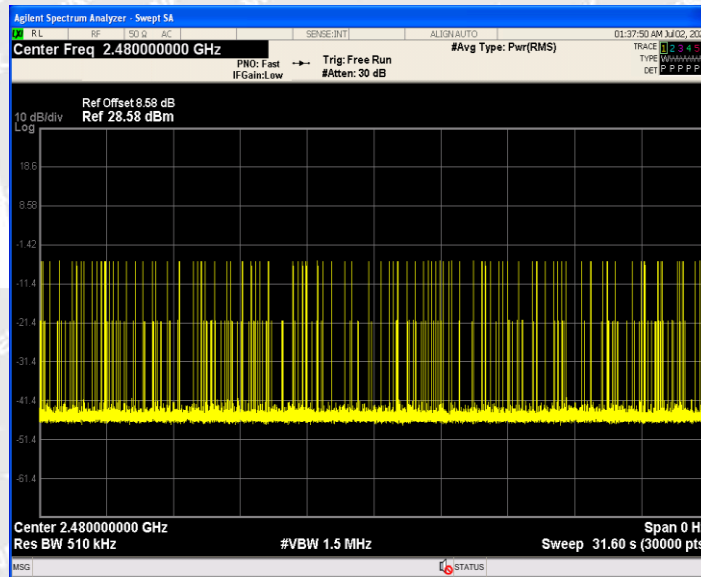



Frequency Occupation requirement					
Modulation	Test Channel	Packet	Burst Number	Limit(Burst Number)	Verdict
GFSK	2402MHz	DH5	1	≥1	Pass
	2480MHz	DH5	4	≥1	Pass
π/4QPSK	2402MHz	2DH5	5	≥1	Pass
	2480MHz	2DH5	2	≥1	Pass
8DPSK	2402MHz	3DH5	2	≥1	Pass
	2480MHz	3DH5	3	≥1	Pass

Test Period: 4 X Dwell time X Minimum number of hopping frequencies (N)
 Occupation Time = Time slot length (Dwell time) X Number of data points within a test period

Test Graphs:

Minimum Frequency Occupation_DH5_2402

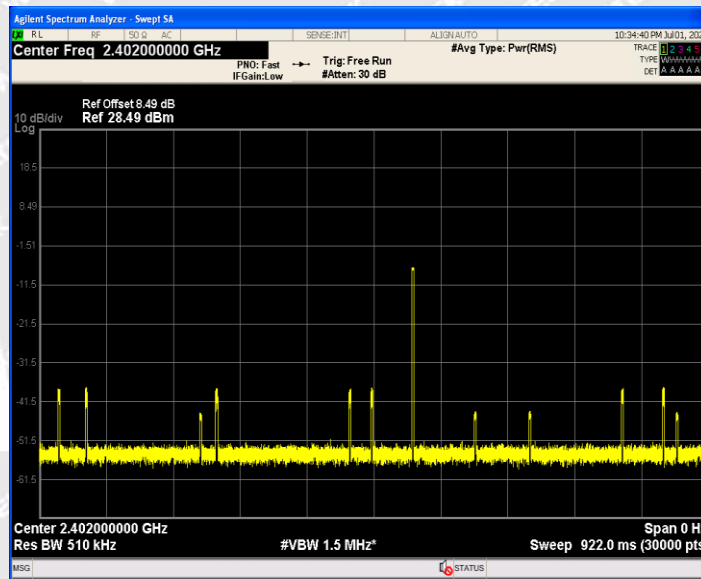

Minimum Frequency Occupation_DH5_2480

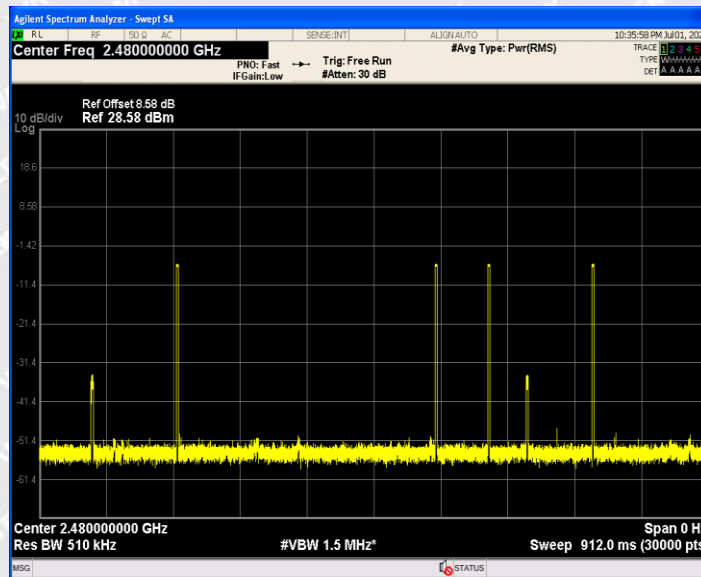



Minimum Frequency Occupation_2DH5_2402

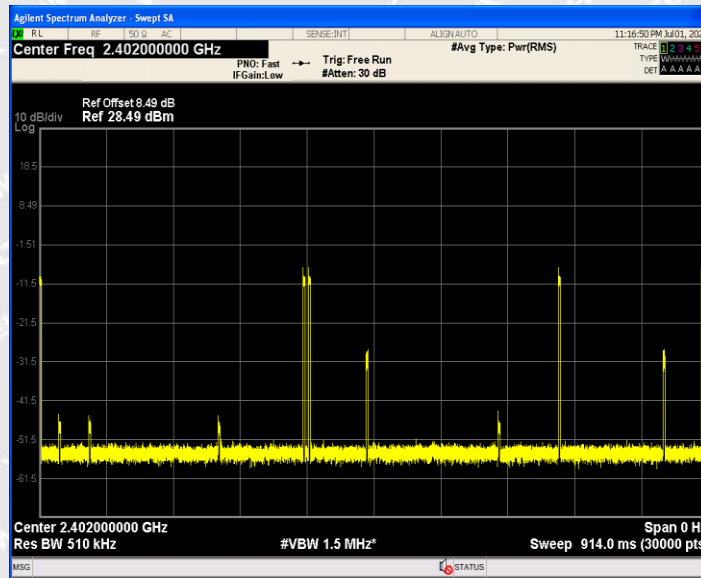

Minimum Frequency Occupation_2DH5_2480

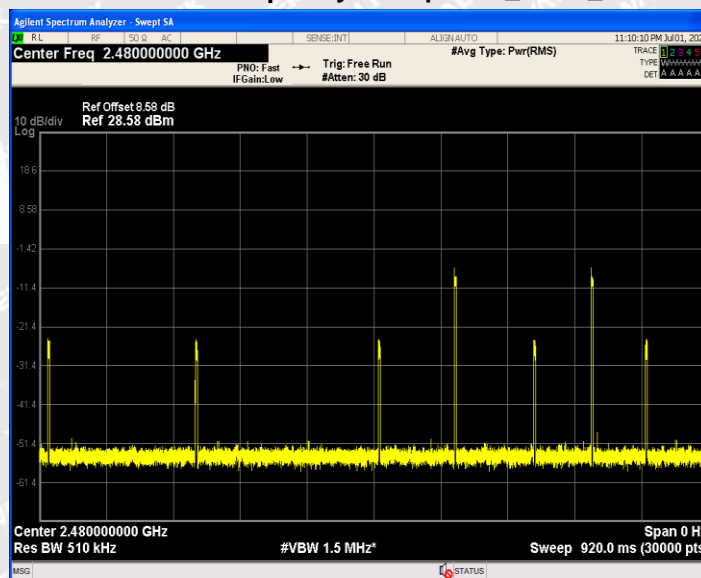



Minimum Frequency Occupation_3DH5_2402

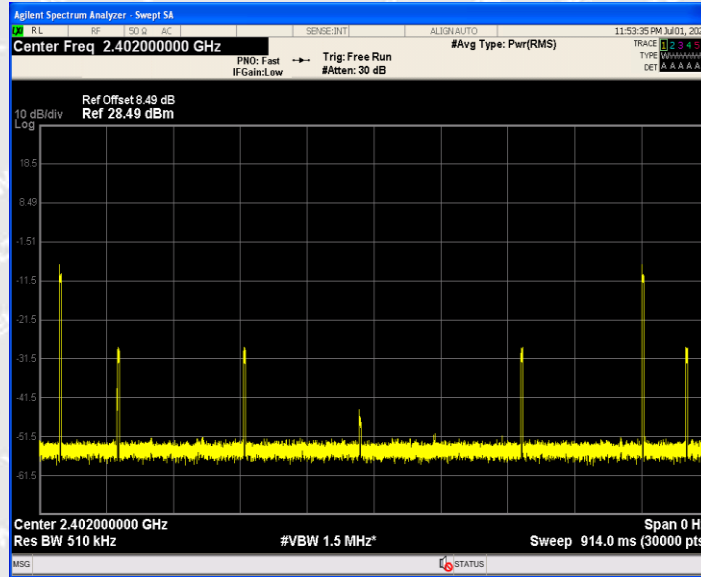

Minimum Frequency Occupation_3DH5_2480

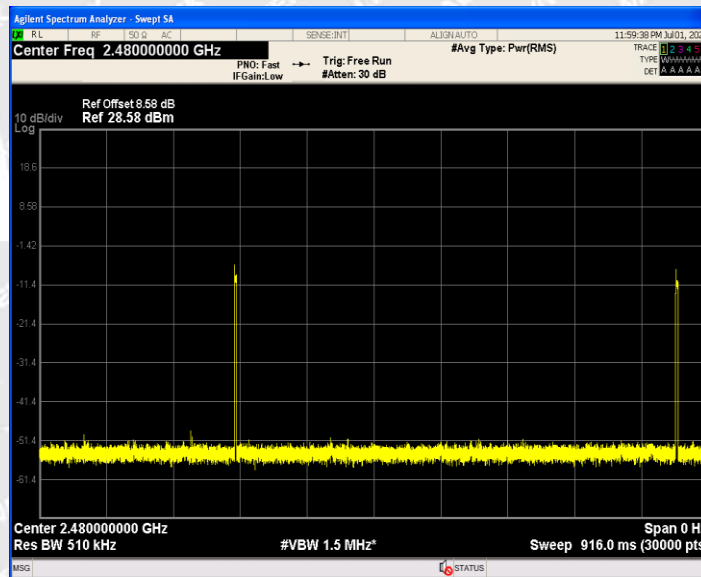



Hopping Sequence							
Modulation	Packet	Test Channel	Hop. (Num.)	Limit (Num.)	Band Use (%)	Limit (%)	Verdict
GFSK	DH5	Hop	79	15	95.43	70	Pass
$\pi/4$ QPSK	2DH5	Hop	79	15	95.96	70	Pass
8DPSK	3DH5	Hop	79	15	95.95	70	Pass

Test Graphs:

Hopping Sequence_DH5

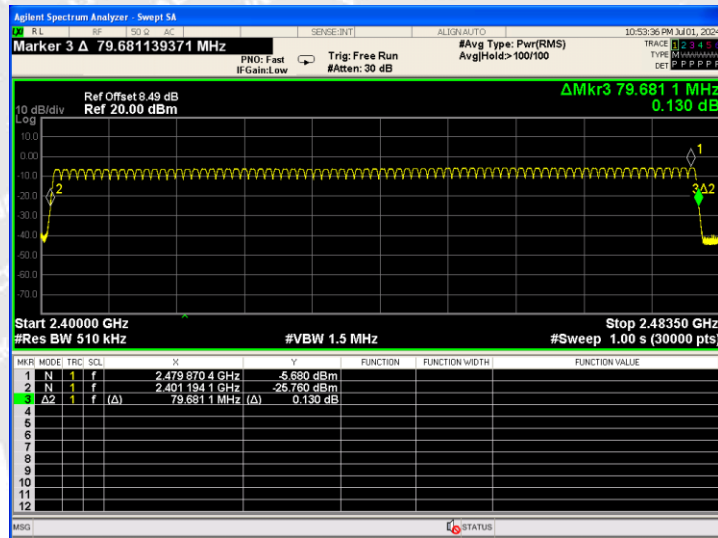

Hopping Sequence_2DH5

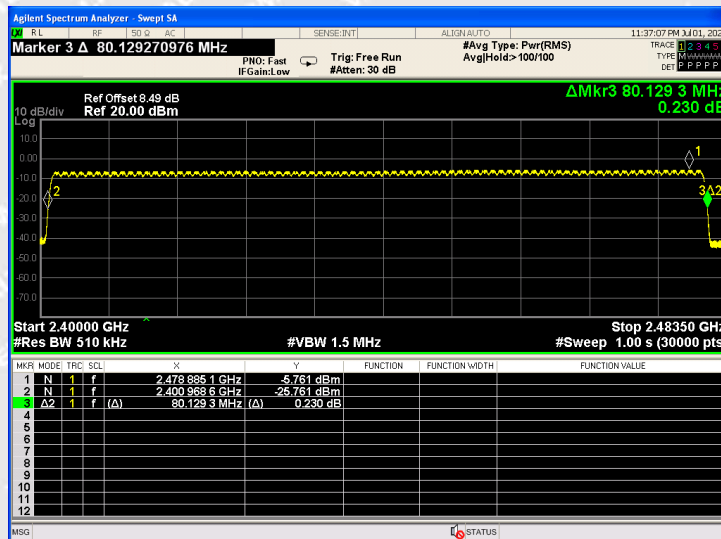



Hopping Sequence_3DH5

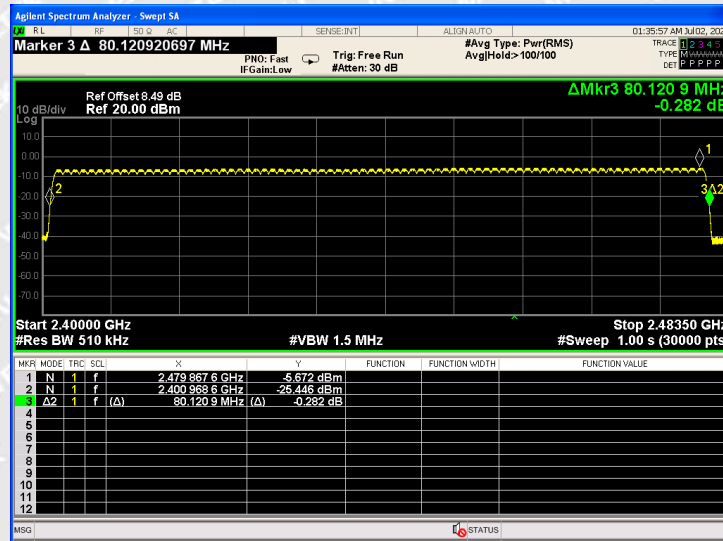

WALTEK



6.3 Hopping Frequency Separation

6.3.1 Standard Applicable

For adaptive FHSS equipment, the minimum Hopping Frequency Separation shall be 100 kHz.

Adaptive FHSS equipment that switched to a non-adaptive mode for one or more hopping frequencies because interference was detected on each of these hopping frequencies with a level above the threshold level defined in clause 4.3.1.7.2.2, point 5 or clause 4.3.1.7.3.2, point 5, does not have to comply with the Hopping Frequency Separation provided in clause 4.3.1.5.3.1 for non-adaptive FHSS equipment. If the Hopping Frequency Separation is below the Occupied Channel Bandwidth but greater than 100 kHz, the equipment is allowed to continue to operate with this Hopping Frequency Separation as long as the interference remains present on these hopping frequencies. As this relaxed Hopping Frequency Separation only applies to adaptive FHSS equipment, the FHSS equipment shall continue to operate in an adaptive mode on all other hopping frequencies.

These measurements shall only be performed at normal test conditions.

6.3.2 Test Procedure

According to the section 5.4.5.2, the measurement procedure shall be as follows:

Step 1:

- The output of the transmitter shall be connected to a spectrum analyser or equivalent.
- The analyser shall be set as follows:
 - Centre Frequency: Centre of the two adjacent hopping frequencies
 - Frequency Span: Sufficient to see the complete power envelope of both hopping frequencies
 - RBW: 1 % of the span
 - VBW: $3 \times$ RBW
 - Detector Mode: Max Peak
 - Trace Mode: Max Hold
 - Sweep Time: Auto

Step 2:

- Wait for the trace to stabilize.
- Use the marker-delta function to determine the Hopping Frequency Separation between the centres of the two adjacent hopping frequencies (e.g. by identifying peaks or notches at the centre of the power envelope for the two adjacent signals). This value shall be compared with the limits defined in clause 4.3.1.5.3 and shall be recorded in the test report.



6.3.3 Test Result

Modulation	Test Channel	Packet	Channel Separation (MHz)	Limit (MHz)	Verdict
GFSK	Hop	DH5	1.074	>=0.1	Pass
$\pi/4$ QPSK	Hop	2DH5	0.838	>=0.1	Pass
8DPSK	Hop	3DH5	0.894	>=0.1	Pass

Test Graphs:

Hopping Frequency Separation_DH5

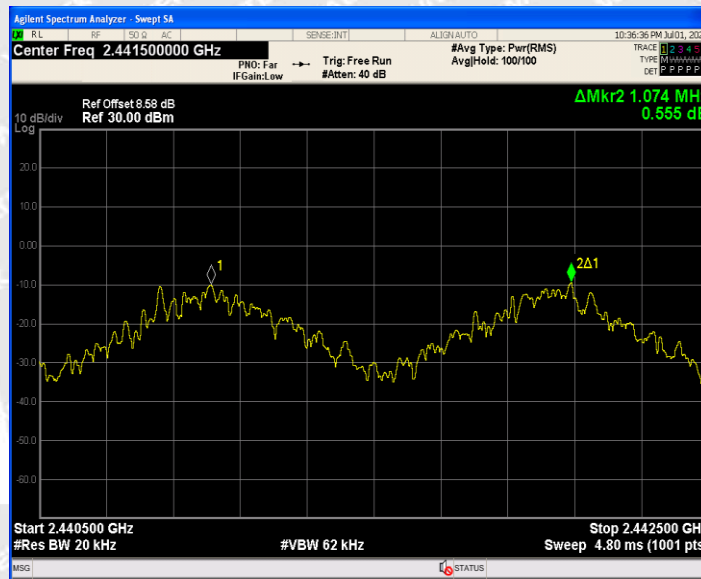

Hopping Frequency Separation_2DH5

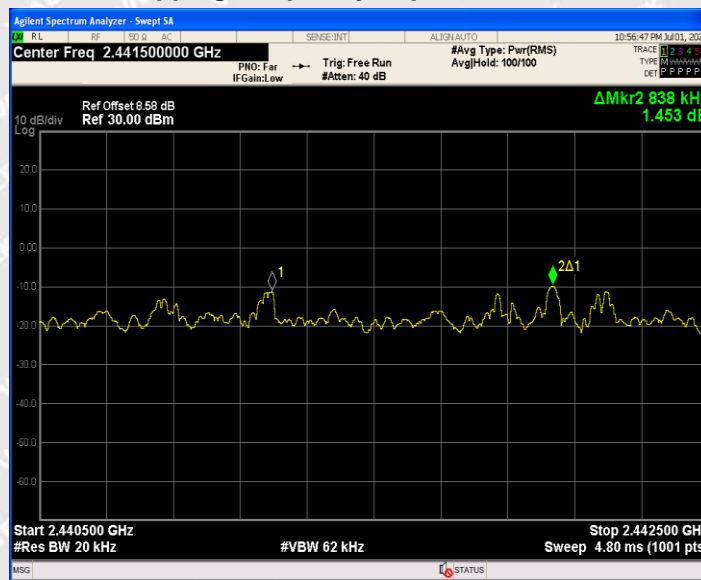



Hopping Frequency Separation_3DH5

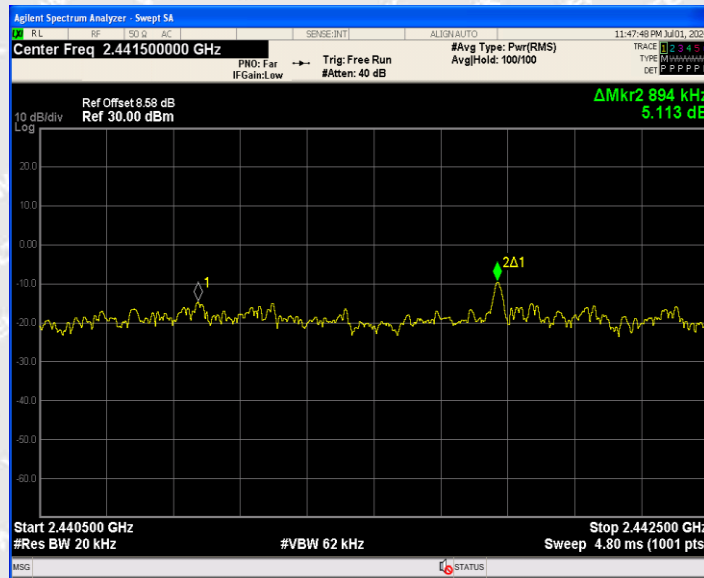

WALTEK



6.4 Occupied Channel Bandwidth

6.4.1 Standard Applicable

The Occupied Channel Bandwidth for each hopping frequency shall be within the band given in table 1.

In addition, for non-adaptive FHSS equipment with e.i.r.p. greater than 10 dBm, the Occupied Channel Bandwidth for every occupied hopping frequency shall be equal to or less than 5 MHz.

6.4.2 Test Procedure

According to section 5.4.7.2, the measurement procedure shall be as follows:

Step 1:

Connect the UUT to the spectrum analyser and use the following settings:

- Centre Frequency: The centre frequency of the channel under test
- Resolution BW: ~ 1 % of the span without going below 1 %
- Video BW: 3 × RBW
- Frequency Span: 2 × Nominal Channel Bandwidth
- Detector Mode: RMS
- Trace Mode: Max Hold
- Sweep time: 1 s

Step 2:

Wait for the trace to stabilize.

Find the peak value of the trace and place the analyser marker on this peak.

Step 3:

Use the 99 % bandwidth function of the spectrum analyser to measure the Occupied Channel Bandwidth of the UUT. This value shall be recorded.

Make sure that the power envelope is sufficiently above the noise floor of the analyser to avoid the noise signals left and right from the power envelope being taken into account by this measurement.

6.4.3 Test Result

Modulation	Channel	Packet	OCB (MHz)	FL (MHz)	FH (MHz)	Limit (MHz)	Verdict
GFSK	2402	DH5	0.87006	2401.59	2402.46	2400 to 2483.5	Pass
	2480		0.87028	2479.59	2480.46	2400 to 2483.5	Pass
$\pi/4$ QPSK	2402	2DH5	1.1920	2401.43	2402.63	2400 to 2483.5	Pass
	2480		1.1927	2479.43	2480.63	2400 to 2483.5	Pass
8DPSK	2402	3DH5	1.2034	2401.42	2402.63	2400 to 2483.5	Pass
	2480		1.2040	2479.43	2480.63	2400 to 2483.5	Pass



Test Graphs:

Occupied Channel Bandwidth_DH5_2402



Occupied Channel Bandwidth_DH5_2480





Occupied Channel Bandwidth_2DH5_2402

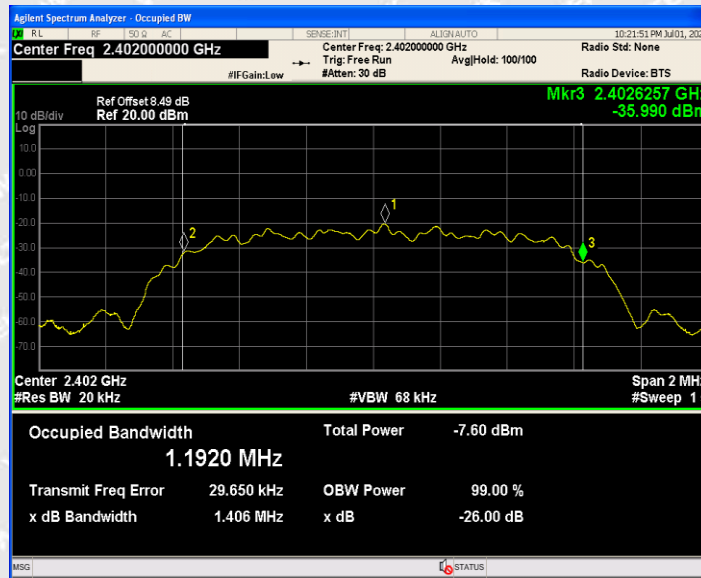

Occupied Channel Bandwidth_2DH5_2480

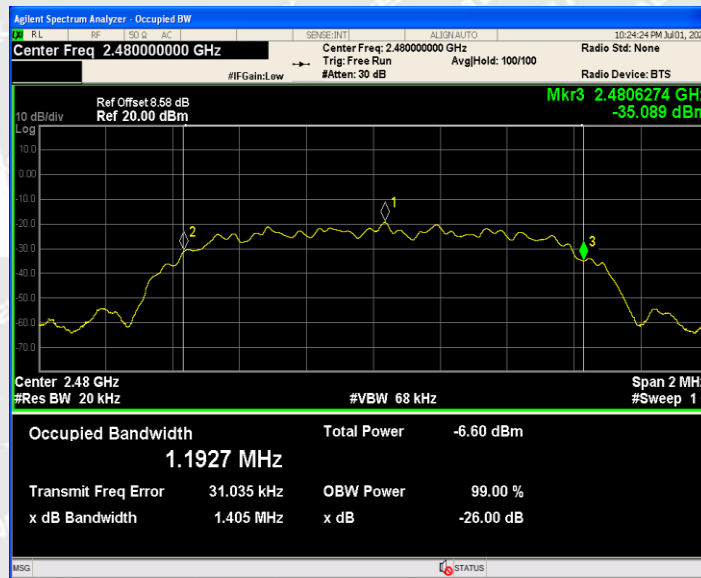



Occupied Channel Bandwidth_3DH5_2402

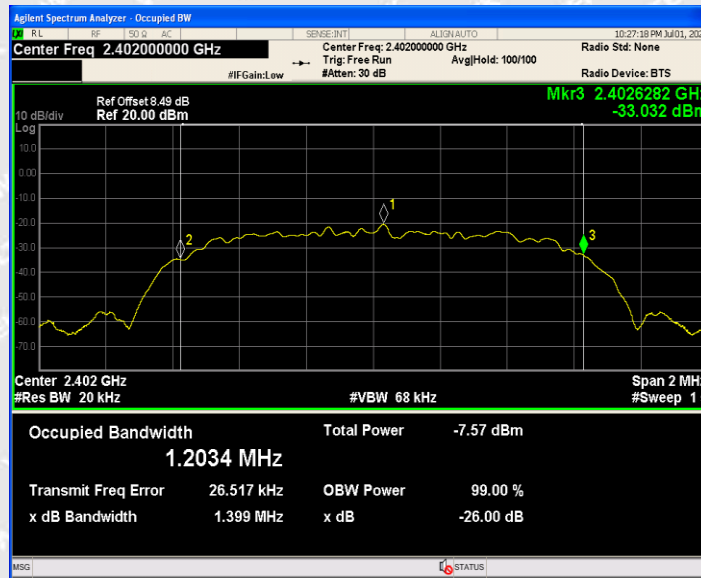

Occupied Channel Bandwidth_3DH5_2480

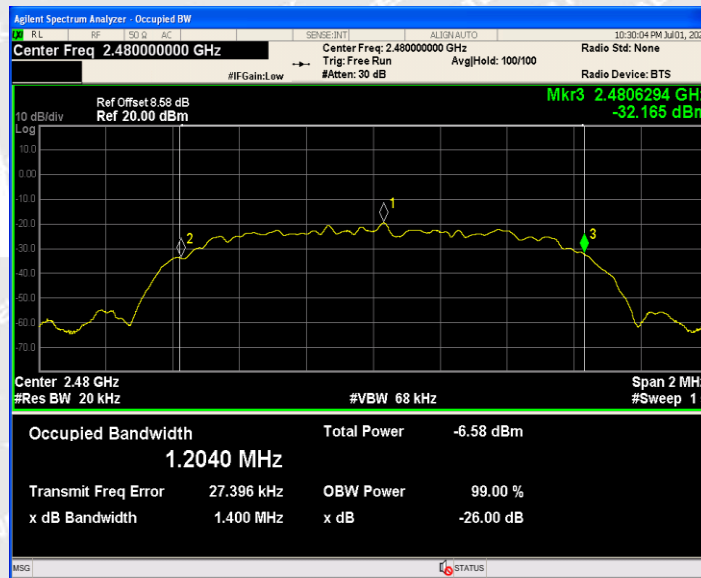



6.5 Transmitter unwanted emissions in the out-of-band domain

6.5.1 Standard Applicable

According to section 4.3.1.9.3, The transmitter unwanted emissions in the out-of-band domain but outside the allocated band, shall not exceed the values provided by the mask in figure below

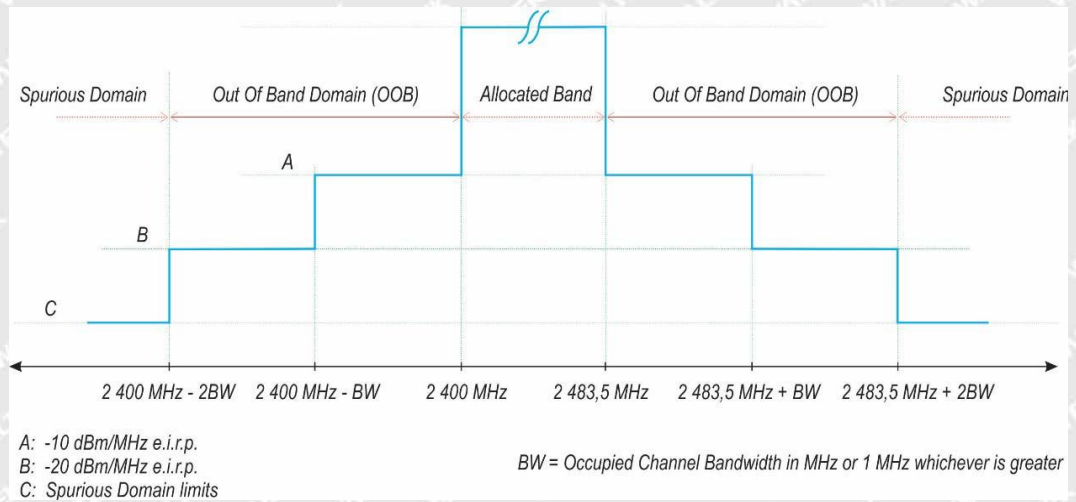

Figure 1: Transmit mask

Within the 2 400 MHz to 2 483,5 MHz band, the Out-of-band emissions are fulfilled by compliance with the Occupied Channel Bandwidth requirement

6.5.2 Test Procedure

According to the section 5.3.9.2.1, the measurement procedure shall be as follows:

The Out-of-band emissions within the different horizontal segments of the mask provided in figures 1 and 3 shall

be measured using the steps below. This method assumes the spectrum analyser is equipped with the Time Domain Power option.

Step 1:

- Connect the UUT to the spectrum analyser and use the following settings:
 - Centre Frequency: 2 484 MHz
 - Span: 0 Hz
 - Resolution BW: 1 MHz
 - Filter mode: Channel filter
 - Video BW: 3 MHz
 - Detector Mode: RMS
 - Trace Mode: Max Hold
 - Sweep Mode: Continuous
 - Sweep Points: Sweep Time [s] / (1 μ s) or 5 000 whichever is greater
 - Trigger Mode: Video trigger



NOTE 1: In case video triggering is not possible, an external trigger source may be used.

- Sweep Time: > 120 % of the duration of the longest burst detected during the measurement of the RF Output Power

Step 2: (segment 2 483,5 MHz to 2 483,5 MHz + BW)

- Adjust the trigger level to select the transmissions with the highest power level.
- For frequency hopping equipment operating in a normal hopping mode, the different hops will result in signal bursts with different power levels. In this case the burst with the highest power level shall be selected.
- Set a window (start and stop lines) to match with the start and end of the burst and in which the RMS power shall be measured using the Time Domain Power function.
- Select RMS power to be measured within the selected window and note the result which is the RMS power within this 1 MHz segment (2 483,5 MHz to 2 484,5 MHz). Compare this value with the applicable limit provided by the mask.
- Increase the centre frequency in steps of 1 MHz and repeat this measurement for every 1 MHz segment within the range 2 483,5 MHz to 2 483,5 MHz + BW. The centre frequency of the last 1 MHz segment shall be set to 2 483,5 MHz + BW - 0,5 MHz (which means this may partly overlap with the previous 1 MHz segment).

Step 3: (segment 2 483,5 MHz + BW to 2 483,5 MHz + 2BW)

- Change the centre frequency of the analyser to 2 484 MHz + BW and perform the measurement for the first 1 MHz segment within range 2 483,5 MHz + BW to 2 483,5 MHz + 2BW. Increase the centre frequency in 1 MHz steps and repeat the measurements to cover this whole range. The centre frequency of the last 1 MHz segment shall be set to 2 483,5 MHz + 2 BW - 0,5 MHz.

Step 4: (segment 2 400 MHz - BW to 2 400 MHz)

- Change the centre frequency of the analyser to 2 399,5 MHz and perform the measurement for the first 1 MHz segment within range 2 400 MHz - BW to 2 400 MHz. Reduce the centre frequency in 1 MHz steps and repeat the measurements to cover this whole range. The centre frequency of the last 1 MHz segment shall be set to 2 400 MHz - 2BW + 0,5 MHz.

Step 5: (segment 2 400 MHz - 2BW to 2 400 MHz - BW)

- Change the centre frequency of the analyser to 2 399,5 MHz - BW and perform the measurement for the first 1 MHz segment within range 2 400 MHz - 2BW to 2 400 MHz - BW. Reduce the centre frequency in 1 MHz steps and repeat the measurements to cover this whole range. The centre frequency of the last 1 MHz segment shall be set to 2 400 MHz - 2BW + 0,5 MHz.

Step 6:

- In case of conducted measurements on equipment with a single transmit chain, the declared antenna assembly gain "G" in dBi shall be added to the results for each of the 1 MHz segments and compared with the limits provided by the mask given in figure 1 or figure 3. If more than one antenna assembly is intended for this power setting, the antenna with the highest gain shall be considered.
- In case of conducted measurements on smart antenna systems (equipment with multiple transmit chains), the measurements need to be repeated for each of the active transmit chains. The declared antenna assembly gain "G" in dBi for a single antenna shall be added to these results. If more than one antenna assembly is intended for this power setting, the antenna with the highest gain shall be considered.



Comparison with the applicable limits shall be done using any of the options given below:

- Option 1: the results for each of the transmit chains for the corresponding 1 MHz segments shall be added. The additional beamforming gain "Y" in dB shall be added as well and the resulting values compared with the limits provided by the mask given in figure 1 or figure 3.

- Option 2: the limits provided by the mask given in figure 1 or figure 3 shall be reduced by $10 \times \log_{10}(A_{ch})$ and the additional beamforming gain Y in dB. The results for each of the transmit chains shall be individually compared with these reduced limits.

NOTE 2: A ch refers to the number of active transmit chains.

It shall be recorded whether the equipment complies with the mask provided in figure 1 or figure 3.

RBW=1MHz VBW=3MHz

6.5.3 Test Result

Test Mode	Test Channel	Packet	Test Segment (MHz)	Max. Emissions Reading (dBm)	Limit (dBm)	Verdict
GFSK	Hop	DH5	2400-2BW to 2400-BW	-60.64	≤ -20	Pass
			2400-BW to 2400	-60.09	≤ -10	Pass
			2483.5 to 2483.5+BW	-49.30	≤ -10	Pass
			2483.5+BW to 2483.5+2BW	-52.84	≤ -20	Pass
$\pi/4$ QPSK	Hop	2DH5	2400-2BW to 2400-BW	-44.35	≤ -20	Pass
			2400-BW to 2400	-42.24	≤ -10	Pass
			2483.5 to 2483.5+BW	-41.21	≤ -10	Pass
			2483.5+BW to 2483.5+2BW	-41.74	≤ -20	Pass
8DPSK	Hop	3DH5	2400-2BW to 2400-BW	-44.17	≤ -20	Pass
			2400-BW to 2400	-42.84	≤ -10	Pass
			2483.5 to 2483.5+BW	-41.65	≤ -10	Pass
			2483.5+BW to 2483.5+2BW	-41.66	≤ -20	Pass



Test Graphs:

OOB_DH5_Hop_2400MHz-2BW to 2400MHz

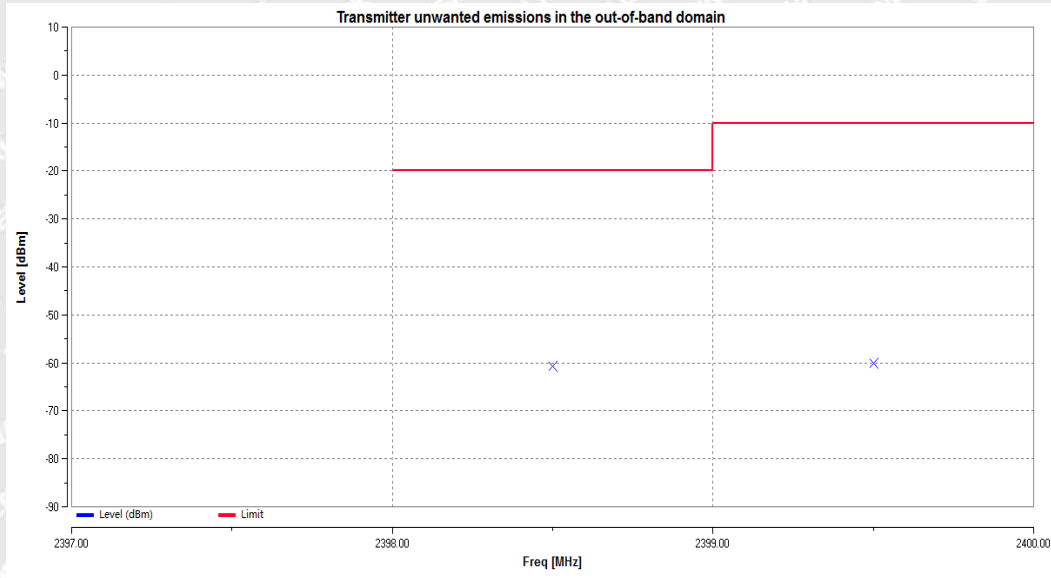

OOB_DH5_Hop_2483.5MHz to 2483.5MHz+2BW

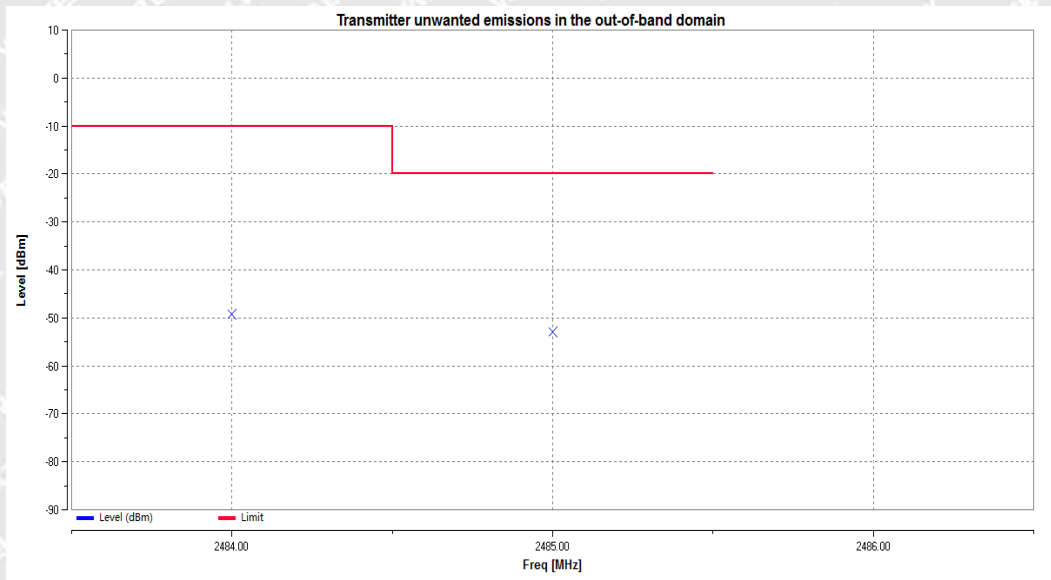



OOB_2DH5_Hop_2400MHz-2BW to 2400MHz

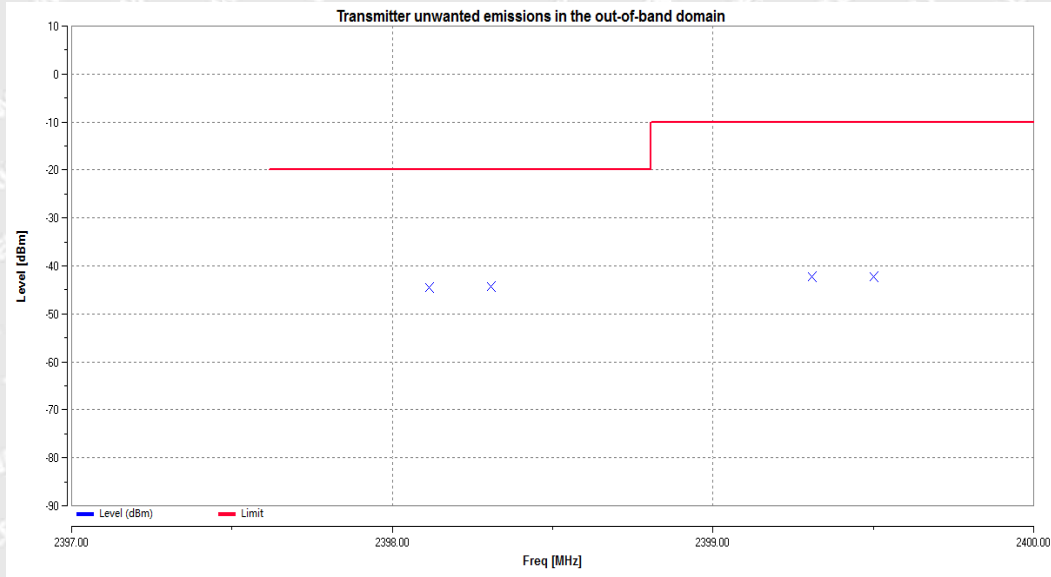

OOB_2DH5_Hop_2483.5MHz to 2483.5MHz+2BW

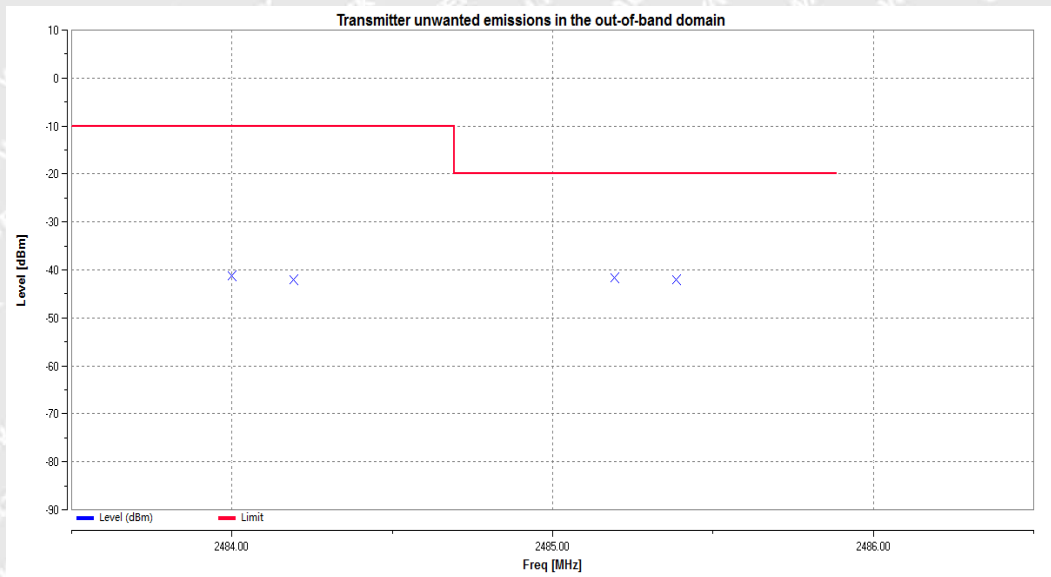



OOB_3DH5_Hop_2400MHz-2BW to 2400MHz

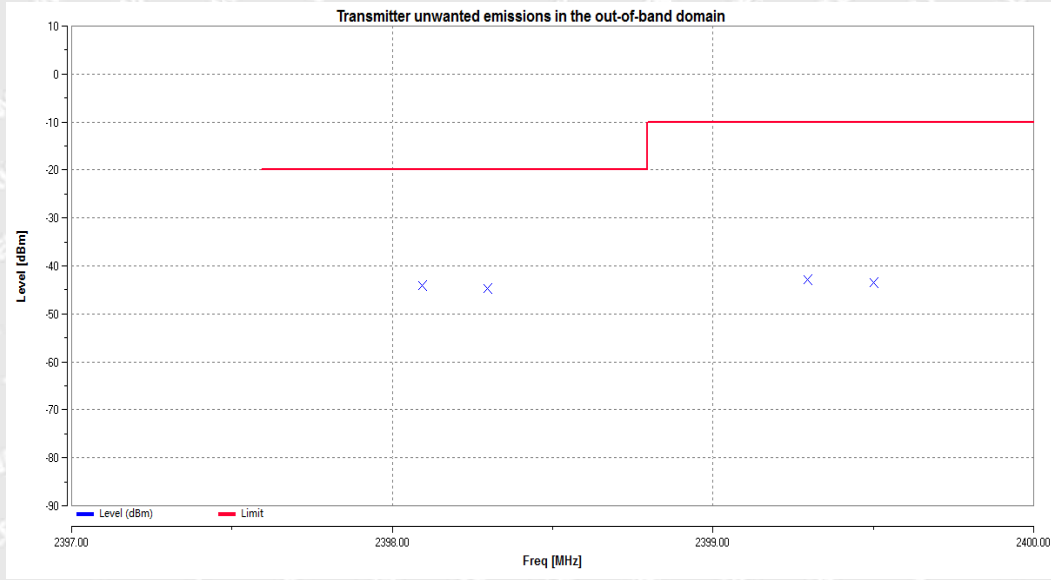

OOB_3DH5_Hop_2483.5MHz to 2483.5MHz+2BW

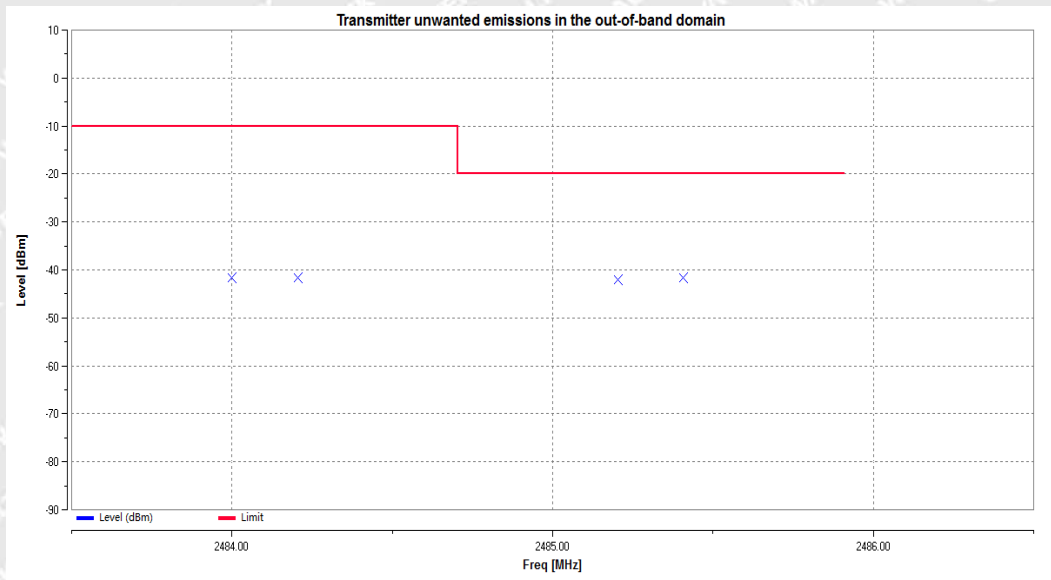



6.6 Transmitter unwanted emissions in the spurious domain

6.6.1 Standard Applicable

According to section 4.3.1.10.3

The transmitter unwanted emissions in the spurious domain shall not exceed the values given in the following table.

Frequency Range	Maximum Power	Bandwidth
30 MHz to 47 MHz	-36 dBm	100 kHz
47 MHz to 74 MHz	-54 dBm	100 kHz
74 MHz to 87,5 MHz	-36 dBm	100 kHz
87,5 MHz to 118 MHz	-54 dBm	100 kHz
118 MHz to 174 MHz	-36 dBm	100 kHz
174 MHz to 230 MHz	-54 dBm	100 kHz
230 MHz to 470 MHz	-36 dBm	100 kHz
470 MHz to 694 MHz	-54 dBm	100 kHz
694 MHz to 1 GHz	-36 dBm	100 kHz
1 GHz to 12,75 GHz	-30 dBm	1 MHz

6.6.2 Test Procedure

The device under test has an integral antenna and the radiated measurement shall apply to the device, using the method of measurement as described in the ETSI EN 300 328 section 5.4.9.2.

RBW=100kHz VBW=300kHz 30MHz-1GHz

RBW=1MHz VBW=3MHz 1GHz-12.75GHz



6.6.3 Test Result

Note: All test modes (different data rate and different modulation) are performed, but only the worst case is recorded in this report.

Frequency (MHz)	Receiver Reading (dB μ V)	Turn table Angle (°)	RX Antenna		Substituted			Absolute Level (dBm)	Limit (dBm)	Margin (dB)
			Height (m)	Polar (H/V)	SG Level (dBm)	Cable (dB)	Antenna Gain (dB)			
TX_DH5_Low Channel										
310.34	33.25	277	1.5	H	-74.46	0.16	0.00	-74.30	-36	-38.30
310.34	33.38	189	1.5	V	-72.37	0.16	0.00	-72.21	-36	-36.21
4776.83	43.10	199	1.6	H	-47.80	2.61	12.70	-57.89	-30	-27.89
4776.83	39.94	185	1.0	V	-48.99	2.61	12.70	-59.08	-30	-29.08
5897.20	41.09	213	1.9	H	-48.00	2.90	12.90	-58.00	-30	-28.00
5897.20	38.80	286	1.9	V	-49.60	2.90	12.90	-59.60	-30	-29.60
TX_DH5_High Channel										
905.08	21.10	116	1.5	H	-74.27	0.22	0.00	-74.05	-36	-38.05
905.08	21.10	292	1.2	V	-74.08	0.22	0.00	-73.86	-36	-37.86
3988.89	43.52	297	1.3	H	-47.29	2.42	12.60	-57.47	-30	-27.47
3988.89	43.26	165	1.3	V	-46.10	2.42	12.60	-56.28	-30	-26.28
5258.57	42.07	227	1.6	H	-47.53	2.81	12.80	-57.52	-30	-27.52
5258.57	39.55	143	1.4	V	-49.27	2.81	12.80	-59.26	-30	-29.26



6.7 Receiver spurious emissions

6.7.1 Standard Applicable

According to section 4.3.1.11.3, The spurious emissions of the receiver shall not exceed the values given in table below

NOTE: In case of equipment with antenna connectors, these limits apply to emissions at the antenna port (conducted) and to the emissions radiated by the cabinet. In case of integral antenna equipment (without temporary antenna connectors), these limits apply to emissions radiated by the equipment. Spurious emission limits for receivers

Frequency Range	Maximum Power	Bandwidth
30 MHz to 1 GHz	-57 dBm	100 kHz
1 GHz to 12,75 GHz	-47 dBm	1 MHz

6.7.2 Test Procedure

The device under test has an integral antenna and the radiated measurement shall apply to the device, using the method of measurement as described in the ETSI EN 300 328 section 5.4.10.2.

RBW=100kHz VBW=300kHz 30MHz-1GHz

RBW=1MHz VBW=3MHz 1GHz-12.75GHz

6.7.3 Test Result

Note: All test modes (different data rate and different modulation) are performed, but only the worst case is recorded in this report.

Frequency (MHz)	Receiver Reading (dBμV)	Turn table Angle (°)	RX Antenna		Substituted			Absolute Level (dBm)	Limit (dBm)	Margin (dB)
			Height (m)	Polar (H/V)	SG Level (dBm)	Cable (dB)	Antenna Gain (dB)			
RX_DH5_Low Channel										
614.05	24.66	123	1.4	H	-74.72	0.20	0.00	-74.52	-57	-17.52
614.05	28.34	194	1.2	V	-70.66	0.20	0.00	-70.46	-57	-13.46
2793.12	45.13	107	1.9	H	-47.88	0.45	10.70	-58.13	-47	-11.13
2793.12	43.76	286	1.4	V	-45.16	0.45	10.70	-55.41	-47	-8.41
3145.63	45.44	187	1.3	H	-46.96	2.08	11.50	-56.38	-47	-9.38
3145.63	40.81	288	1.9	V	-49.60	2.08	11.50	-59.02	-47	-12.02
RX_DH5_High Channel										
170.96	34.50	177	1.5	H	-75.10	0.15	0.00	-74.95	-57	-17.95
170.96	36.99	274	1.4	V	-70.50	0.15	0.00	-70.35	-57	-13.35
4730.93	42.13	262	1.3	H	-48.77	2.61	12.70	-58.86	-47	-11.86
4730.93	40.18	254	1.6	V	-48.75	2.61	12.70	-58.84	-47	-11.84
5682.10	41.53	279	1.8	H	-48.02	2.87	12.90	-58.05	-47	-11.05
5682.10	43.65	223	1.8	V	-45.46	2.87	12.90	-55.49	-47	-8.49



6.8 Receiver Blocking

6.8.1 Standard Applicable

According to section 4.3.1.12.3, Receiver blocking is a measure of the ability of the equipment to receive a wanted signal on its operating channel without exceeding a given degradation in the presence of an unwanted signal (blocking signal) at frequencies other than those of the operating band.

Load Based Equipment not using any of the mechanisms referenced above shall comply with the following minimum set of requirements :

The minimum performance criterion shall be a PER less than or equal to 10 %. The manufacturer may declare alternative performance criteria as long as that is appropriate for the intended use of the equipment (see clause 5.4.1.t)).

While maintaining the minimum performance criteria as defined in clause 4.3.1.12.3, the blocking levels at specified frequency offsets shall be equal to or greater than the limits defined for the applicable receiver category 1, 2 and 3 provided in table 14, table 15 or table 16.

Receiver category 1

Adaptive equipment with a maximum RF output power greater than 10 dBm e.i.r.p. shall be considered as receiver category 1 equipment.

Table 6: Receiver Blocking parameters for Receiver Category 1 equipment

Wanted signal mean power from companion device (dBm) (see notes 1 and 4)	Blocking signal frequency (MHz)	Blocking signal power (dBm) (see note 4)	Type of blocking signal
(-133 dBm + 10 × log ₁₀ (OCBW)) or -68 dBm whichever is less (see note 2)	2 380 2 504		
(-139 dBm + 10 × log ₁₀ (OCBW)) or -74 dBm whichever is less (see note 3)	2 300 2 330 2 360 2 524 2 584 2 674	-34	CW

NOTE 1: OCBW is in Hz.

NOTE 2: In case of radiated measurements using a companion device and the level of the wanted signal from the companion device cannot be determined, a relative test may be performed using a wanted signal up to P_{min} + 26 dB where P_{min} is the minimum level of wanted signal required to meet the minimum performance criteria as defined in clause 4.3.1.12.3 in the absence of any blocking signal.

NOTE 3: In case of radiated measurements using a companion device and the level of the wanted signal from the companion device cannot be determined, a relative test may be performed using a wanted signal up to P_{min} + 20 dB where P_{min} is the minimum level of wanted signal required to meet the minimum performance criteria as defined in clause 4.3.1.12.3 in the absence of any blocking signal.

NOTE 4: The level specified is the level at the UUT receiver input assuming a 0 dBi antenna assembly gain. In case of conducted measurements, this level has to be corrected for the (in-band) antenna assembly gain (G). In case of radiated measurements, this level is equivalent to a power flux density (PFD) in front of the UUT antenna with the UUT being configured/positioned as recorded in clause 5.4.3.2.2.



Receiver category 2

Non-adaptive equipment with a Medium Utilization (MU) factor greater than 1 % and less than or equal to 10 % or adaptive equipment with a maximum RF output power of 10 dBm e.i.r.p. shall be considered as receiver category 2 equipment.

Table 7: Receiver Blocking parameters for Receiver Category 2 equipment

Wanted signal mean power from companion device (dBm) (see notes 1 and 3)	Blocking signal frequency (MHz)	Blocking signal power (dBm) (see note 3)	Type of blocking signal
(-139 dBm + 10 × log ₁₀ (OCBW) + 10 dB) or (-74 dBm + 10 dB) whichever is less (see note 2)	2 380 2 504 2 300 2 584	-34	CW
NOTE 1: OCBW is in Hz.			
NOTE 2: In case of radiated measurements using a companion device and the level of the wanted signal from the companion device cannot be determined, a relative test may be performed using a wanted signal up to P _{min} + 26 dB where P _{min} is the minimum level of wanted signal required to meet the minimum performance criteria as defined in clause 4.3.1.12.3 in the absence of any blocking signal.			
NOTE 3: The level specified is the level at the UUT receiver input assuming a 0 dBi antenna assembly gain. In case of conducted measurements, this level has to be corrected for the (in-band) antenna assembly gain (G). In case of radiated measurements, this level is equivalent to a power flux density (PFD) in front of the UUT antenna with the UUT being configured/positioned as recorded in clause 5.4.3.2.2.			

Receiver category 3

Non-adaptive equipment with a maximum Medium Utilization (MU) factor of 1 % or adaptive equipment with a maximum RF output power of 0 dBm e.i.r.p. shall be considered as receiver category 3 equipment.

Table 8: Receiver Blocking parameters for Receiver Category 3 equipment

Wanted signal mean power from companion device (dBm) (see notes 1 and 3)	Blocking signal frequency (MHz)	Blocking signal power (dBm) (see note 3)	Type of blocking signal
(-139 dBm + 10 × log ₁₀ (OCBW) + 20 dB) or (-74 dBm + 20 dB) whichever is less (see note 2)	2 380 2 504 2 300 2 584	-34	CW
NOTE 1: OCBW is in Hz.			
NOTE 2: In case of radiated measurements using a companion device and the level of the wanted signal from the companion device cannot be determined, a relative the test may be performed using a wanted signal up to P _{min} + 30 dB where P _{min} is the minimum level of wanted signal required to meet the minimum performance criteria as defined in clause 4.3.1.12.3 in the absence of any blocking signal.			
NOTE 3: The level specified is the level at the UUT receiver input assuming a 0 dBi antenna assembly gain. In case of conducted measurements, this level has to be corrected for the (in-band) antenna assembly gain (G). In case of radiated measurements, this level is equivalent to a power flux density (PFD) in front of the UUT antenna with the UUT being configured/positioned as recorded in clause 5.4.3.2.2.			



6.8.2 Test Procedure

Step 1:

- For non-frequency hopping equipment, the UUT shall be set to the lowest operating channel.

Step 2:

- The blocking signal generator is set to the first frequency as defined in the appropriate table corresponding to the receiver category and type of equipment.

Step 3:

- With the blocking signal generator switched off, a communication link is established between the UUT and the associated companion device using the test setup shown in figure 6. The variable attenuator is set to a value that achieves the minimum performance criteria as specified in clause 4.3.1.12.3 or clause 4.3.2.11.3 with a resolution of at least 1 dB. The resulting level for the wanted signal at the input of the UUT is P_{min} . This value shall be measured and recorded in the test report.

- The signal level is increased by the value provided in the table corresponding to the receiver category and type of equipment.

Step 4:

- The blocking signal at the UUT is set to the level provided in the table corresponding to the receiver category and type of equipment. It shall be verified and recorded in the test report that the performance criteria as specified in clause 4.3.1.12.3 or clause 4.3.2.11.3 is met.

Step 5:

- Repeat step 4 for each remaining combination of frequency and level for the blocking signal as provided in the table corresponding to the receiver category and type of equipment.

Step 6:

- For non-frequency hopping equipment, repeat step 2 to step 5 with the UUT operating at the highest operating channel.

6.8.3 Test Setup

According to the section 5.4.11.2.1, the test block diagram shall be used.

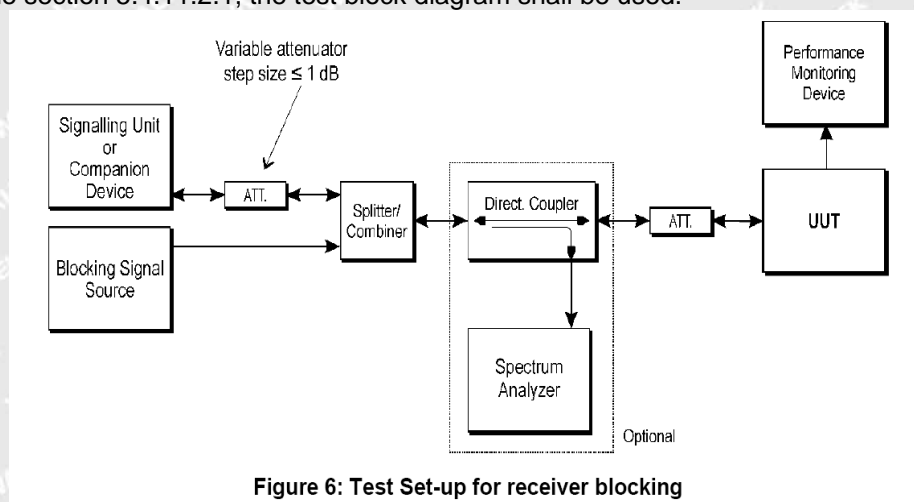

Figure 6: Test Set-up for receiver blocking

All test procedure is carried to the section 5.4.11.2.1
RBW/VBW=8MHz/30MHz



6.8.4 Test Result

GFSK_DH5						
Receiver Blocking Categories 3						
Wanted signal meanpower from companion device (dBm)	OCBW (Hz)	Blocking signal frequency (MHz)	Blocking signal power(dBm) CW	PER (%)	Limit	Results
-59.60	870060	2380	-34	5.2	≤10%	Pass
		2504	-34	5.2		
		2300	-34	5.4		
		2584	-34	1.3		

NOTE 1: For equipment that supports a PER or FER test to be performed, the minimum performance criterion shall be a PER or FER less than or equal to 10 %.

NOTE 2: For equipment that does not support a PER or a FER test to be performed, the minimum performance criterion shall be no loss of the wireless transmission function needed for the intended use of the equipment.

NOTE 3: The smallest channel bandwidth and the lowest data rate for this channel bandwidth which still allows the equipment to operate as intended shall be used. This mode of operation shall be aligned with the performance criteria defined in clause 4.3.1.12.3 or clause 4.3.2.11.3 and shall be described in the test report.

$\pi/4$ QPSK_2DH5						
Receiver Blocking Categories 3						
Wanted signal meanpower from companion device (dBm)	OCBW (Hz)	Blocking signal frequency (MHz)	Blocking signal power(dBm) CW	PER (%)	Limit	Results
-58.24	1192000	2380	-34	3.0	≤10%	Pass
		2504	-34	5.7		
		2300	-34	0.7		
		2584	-34	5.6		

NOTE 1: For equipment that supports a PER or FER test to be performed, the minimum performance criterion shall be a PER or FER less than or equal to 10 %.

NOTE 2: For equipment that does not support a PER or a FER test to be performed, the minimum performance criterion shall be no loss of the wireless transmission function needed for the intended use of the equipment.

NOTE 3: The smallest channel bandwidth and the lowest data rate for this channel bandwidth which still allows the equipment to operate as intended shall be used. This mode of operation shall be aligned with the performance criteria defined in clause 4.3.1.12.3 or clause 4.3.2.11.3 and shall be described in the test report.



8DPSK_3DH5						
Receiver Blocking Categories 3						
Wanted signal meanpower from companion device (dBm)	OCBW (Hz)	Blocking signal frequency (MHz)	Blocking signal power(dBm) CW	PER (%)	Limit	Results
-58.20	1203400	2380	-34	3.1	≤10%	Pass
		2504	-34	1.9		
		2300	-34	1.2		
		2584	-34	2.6		
<p>NOTE 1: For equipment that supports a PER or FER test to be performed, the minimum performance criterion shall be a PER or FER less than or equal to 10 %.</p> <p>NOTE 2: For equipment that does not support a PER or a FER test to be performed, the minimum performance criterion shall be no loss of the wireless transmission function needed for the intended use of the equipment.</p> <p>NOTE 3: The smallest channel bandwidth and the lowest data rate for this channel bandwidth which still allows the equipment to operate as intended shall be used. This mode of operation shall be aligned with the performance criteria defined in clause 4.3.1.12.3 or clause 4.3.2.11.3 and shall be described in the test report.</p>						

WALTEK



7 Photographs – Test Setup

7.1 Photograph – Spurious Emissions Test Setup

Below 1GHz



Above 1GHz





8 Photographs – EUT Constructional Details

Please refer to “ANNEX”.

====End of Report=====

WALTEK



中国认可
国际互认
检测
TESTING
CNAS L6478



TEST REPORT

Reference No...... : WTF24F05107651W002
Applicant..... : Mid Ocean Brands B.V.
Address..... : 7/F., Kings Tower, 111 King Lam Street, Cheung Sha Wan, Kowloon, Hong Kong
Manufacturer : 117486
Address..... : ---
Product Name..... : Wireless multi 4 in 1 speaker
Model No...... : MO2378
Test specification..... : ETSI EN 303 417 V1.1.1 (2017-09)
Date of Receipt sample : 2024-05-30
Date of Test : 2024-06-28
Date of Issue..... : 2024-07-09
Test Report Form No. : WEW-303417A-01B
Test Result..... : **Pass**

Remarks:

The results shown in this test report refer only to the sample(s) tested, this test report cannot be reproduced, except in full, without prior written permission of the company. The report would be invalid without specific stamp of test institute and the signatures of approver.

Prepared By:

Waltek Testing Group (Foshan) Co., Ltd.

Address: 1/F., Building 19, Sunlink Machinery City, Xingye 4 Road,
Guanglong Industrial Park, Chihua Neighborhood Committee, Chencun Town,
Shunde District, Foshan, Guangdong, China

Tel:+86-757-23811398 Fax:+86-757-23811381 E-mail:info@waltek.com.cn

Tested by:

Roy Hong

Approved by:

Danny Zhou



1 Test Summary

Radio Spectrum			
Test	Test Requirement	Reference	Result
Permitted range of operating frequencies	ETSI EN 303 417 V1.1.1	4.3.2	Pass
Operating frequency ranges	ETSI EN 303 417 V1.1.1	4.3.3	Pass
H-field requirements	ETSI EN 303 417 V1.1.1	4.3.4	Pass
Transmitter spurious emissions	ETSI EN 303 417 V1.1.1	4.3.5	Pass
Transmitter out of band (OOB) emissions	ETSI EN 303 417 V1.1.1	4.3.6	Pass
WPT system unwanted conducted emissions	ETSI EN 303 417 V1.1.1	4.3.7	N/A
Receiver blocking	ETSI EN 303 417 V1.1.1	4.4.2	Pass

Remark:

- Pass The EUT complies with the essential requirements in the standard
- Fail The EUT does not comply with the essential requirements in the standard
- N/A Not Applicable

WALTEK



2 Contents

	Page
1 TEST SUMMARY	2
2 CONTENTS	3
3 GENERAL INFORMATION	5
3.1 GENERAL DESCRIPTION OF E.U.T.	5
3.2 DETAILS OF E.U.T.	5
3.3 STANDARDS APPLICABLE FOR TESTING	6
3.4 TEST FACILITY.....	6
3.5 SUBCONTRACTED.....	7
3.6 ABNORMALITIES FROM STANDARD CONDITIONS	7
3.7 DISCLAIMER	7
4 EQUIPMENT USED DURING TEST	8
4.1 EQUIPMENT LIST	8
4.2 SOFTWARE LIST.....	9
4.3 SPECIAL ACCESSORIES AND AUXILIARY EQUIPMENT	9
4.4 MEASUREMENT UNCERTAINTY	9
4.5 DECISION RULE	9
5 TEST CONDITIONS AND TEST MODE	10
6 PERMITTED RANGE OF OPERATING FREQUENCY	11
6.1 STANDARD APPLICABLE	11
6.2 TEST PROCEDURE	11
6.3 TEST RESULT.....	11
7 OPERATING FREQUENCY RANGES	12
7.1 STANDARD APPLICABLE	12
7.2 TEST PROCEDURE	13
7.3 TEST RESULT.....	13
8 TRANSMITTER H-FIELD REQUIREMENTS	15
8.1 STANDARD APPLICABLE	15
8.2 TEST PROCEDURE	15
8.3 TEST RESULT.....	15
9 TRANSMITTER SPURIOUS EMISSIONS	16
9.1 STANDARD APPLICABLE	16
9.2 TEST PROCEDURE	17
9.3 TEST RESULT.....	18
10 TRANSMITTER OUT OF BAND(OOB) EMISSIONS	26
10.1 STANDARD APPLICABLE	26
10.2 TEST PROCEDURE	26
10.3 TEST RESULT.....	26
11 RECEIVER BLOCKING	27
11.1 STANDARD APPLICABLE	27
11.2 TEST PROCEDURE	27
11.3 TEST RESULT.....	27
12 PHOTOGRAPHS – TEST SETUP	28



12.1 PHOTOGRAPH – SPURIOUS EMISSIONS TEST SETUP.....28

13 PHOTOGRAPHS – EUT CONSTRUCTIONAL DETAILS.....29

WALTEK



3 General Information

3.1 General Description of E.U.T.

Product Name	: Wireless multi 4 in 1 speaker
Model No.	: MO2378
Remark	: ---
Rating	: Type-C Input: DC 5V, 3A or DC 9V, 3A Wireless output: 15W Max.
Battery Capacity	: 1200mAh
Adapter Model	: ---

3.2 Details of E.U.T.

Frequency Bands	: 110-205kHz
Radiated H-Field	: 24.45 dBuA/m(@3m)
Antenna Type	: Coil Antenna

Overview of operational modes within a WPT system

Operational Mode	Set-up	Function of base station	Function of mobile device	Test scenario	Conformance Requirements
Mode 1: base station in stand-by, idle mode	Single device	Transmitter	Not applicable	Single radiation test (TX) with the base station/charging pad. The test set-up as described in clause 6.1.2 shall be used.	Operating frequency range (clause 4.3.3) H-Field emission (clause 4.3.4) TX spurious (clauses 4.3.5, 4.3.6 and 4.3.7) Performance criteria test (RX test) (clause 4.4)
Mode 2: Communication before charging, adjustment charging mode / position	In combination	TX and RX	TX and RX	Specific test setup, declared by the manufacturer. Manufacturer shall declare the maximal distance between base station and mobile device the WPT system is able to communicate (distance D).The test setup- up shall be performed with the largest communication distance.The test set-up as described in clause 6.1.3 shall be used.	Operating frequency range (clause 4.3.3) H-Field emission (clause 4.3.4) TX spurious (clauses 4.3.5, 4.3.6 and 4.3.7) Wanted performance criteria test (RX test) (clause 4.4)



Operational Mode	Set-up	Function of base station	Function of mobile device	Test scenario	Conformance Requirements
Mode3: Communication	WPT system alignment	TX and RX	TX and RX	Worst case alignment	Operating frequency range (clause 4.3.3) H-Field emission (clause 4.3.4) TX spurious (clauses 4.3.5, 4.3.6 and 4.3.7) Wanted Performance criteria test (RX test) (clause 4.4)
Mode 4: energy transmission	WPT system alignment	TX and RX	TX and RX	Both tests can be performed within one set-up, worst-case alignment. The test set-up as described in clause 6.1.4 shall be used.	

3.3 Standards Applicable for Testing

The tests were performed according to following standards:

ETSI EN 303 417 V1.1.1 (2017-09) Wireless power transmission systems, using technologies other than radio frequency beam in the 19 - 21 kHz, 59 - 61 kHz, 79 - 90 kHz, 100 - 300 kHz, 6765 - 6795 kHz ranges; Harmonised Standard covering the essential requirements of article 3.2 of Directive 2014/53/EU.

3.4 Test Facility

The test facility has a test site registered with the following organizations:

- **ISED – Registration No.: 21895**

Waltek Testing Group (Foshan) Co., Ltd. has been registered and fully described in a report filed with the Innovation, Science and Economic Development Canada (ISED). The acceptance letter from the ISED is maintained in our files. Registration ISED number: 21895, March 12, 2019

- **FCC – Registration No.: 820106**

Waltek Testing Group (Foshan) Co., Ltd. EMC Laboratory has been registered and fully described in a report filed with the (FCC) Federal Communications Commission. The acceptance letter from the FCC is maintained in our files. Registration 820106, August 16, 2018

- **NVLAP – Lab Code: 600191-0**

Waltek Testing Group (Foshan) Co., Ltd. EMC Laboratory is accredited by the National Voluntary Laboratory Accreditation Program (NVLAP/NIST). NVLAP Code: 600191-0.

This report must not be used by the client to claim product certification, approval, or endorsement by NVLAP, NIST, or any agency of the Federal Government.



3.5 Subcontracted

Whether parts of tests for the product have been subcontracted to other labs:

Yes No

If Yes, list the related test items and lab information:

Test items: ---

Lab information: ---

3.6 Abnormalities from Standard Conditions

None.

3.7 Disclaimer

The antenna gain information is provided by the customer. The laboratory is not responsible for the accuracy of the antenna gain information.

WALTEK



4 Equipment Used during Test

4.1 Equipment List

<input checked="" type="checkbox"/> 3m Semi-anechoic Chamber for Spurious Emission						
Item	Equipment	Manufacturer	Model No.	Serial No.	Last Calibration Date	Calibration Due Date
1	3m Semi-anechoic Chamber	CHANGCHUANG	9m×6m×6m	-	2024-01-05	2025-01-04
2	EMI TEST RECEIVER	RS	ESR7	101566	2024-01-06	2025-01-05
3	Spectrum Analyzer	Agilent	N9020A	MY48011796	2024-01-04	2025-01-03
4	Trilog Broadband Antenna	SCHWARZBECK	VULB9162	9162-117	2024-01-05	2025-01-04
5	Coaxial Cable (below 1GHz)	H+S	CBL3-NN-12+3 m	214NN320	2024-01-06	2025-01-05
6	Broad-band Horn Antenna	SCHWARZBECK	BBHA 9120 D	01561	2024-01-05	2025-01-04
7	Broadband Preamplifier (Above 1GHz)	Lunar E M	LNA1G18-40	20160501002	2024-01-04	2025-01-03
8	Coaxial Cable (above 1GHz)	Times-Microwave	CBL5-NN	-	2024-01-04	2025-01-03
<input checked="" type="checkbox"/> RF Conducted test						
Item	Equipment	Manufacturer	Model No.	Serial No.	Last Calibration Date	Calibration Due Date
1	Environmental Chamber	KSON	THS-D4C-100	5244K	2024-01-17	2025-01-16
2	Spectrum Analyzer	Agilent	N9020A	MY48011796	2024-01-04	2025-01-03
3	EXG Analog Signal Generator	Agilent	N5181A	MY48180720	2024-01-04	2025-01-03
4	RF Control Unit	CHANGCHUANG	JS0806-2	-	2024-01-04	2025-01-03
5	Wideband radio communication tester	Rohde&Schwarz	CMW500	1201.0002K50-158178-Qf	2024-01-04	2025-01-03
6	USB Wideband Power Sensor	KEYSIGHT	U2021XA	MY56510008	2024-01-04	2025-01-03

: Not Used

: Used



4.2 Software List

Description	Manufacturer	Model	Version
EMI Test Software (Radiated Emission)	FARATRONIC	EZ-EMC	RA-03A1-1
RF Conducted Test	TONSCEND	JS1120-2	2.6

4.3 Special Accessories and Auxiliary Equipment

Item	Equipment	Technical Data	Manufacturer	Model No.
1.	AC Adapter	Input: 100-240V~, 50/60Hz, 0.7A; Output: 5VDC, 3A or 9VDC, 3A or 12VDC, 2.25A or 20VDC, 1.35A or 11VDC, 3A Max	Xiaomi	MDY-11-EX

4.4 Measurement Uncertainty

Parameter	Uncertainty	Note
RF Output Power	$\pm 2.2\text{dB}$	(1)
Occupied Bandwidth	$\pm 1.5\%$	(1)
Transmitter Spurious Emission	$\pm 3.8\text{dB}$ (for 25MHz-1GHz)	(1)
	$\pm 5.0\text{dB}$ (for 1GHz-18GHz)	(1)

(1) This uncertainty represents an expanded uncertainty expressed at approximately the 95% confidence level using a coverage factor of $k=2$.

4.5 Decision Rule

Compliance or non-compliance with a disturbance limit shall be determined in the following manner.

If U_{LAB} is less than or equal to U_{cispr} , then

-Compliance is deemed to occur if no measured disturbance level exceeds the disturbance limit;

-Non-compliance is deemed to occur if any measured disturbance level exceeds the disturbance limit.

If U_{LAB} is greater than U_{cispr} , then

-Compliance is deemed to occur if no measured disturbance level, increased by $(U_{\text{LAB}} - U_{\text{cispr}})$, exceeds the disturbance limit;

-Non-compliance is deemed to occur if any measured disturbance level, increased by $(U_{\text{LAB}} - U_{\text{cispr}})$, exceeds the disturbance limit.



5 Test Conditions and Test mode

The equipment under test (EUT) was configured to measure its highest possible emission/immunity level. The test modes were adapted according to the operation manual for use, the EUT was operated in the continuous transmitting mode that was for the purpose of the measurements, more detailed description as follows:

Test Mode List		
Test Mode	Description	Remark
TM1	Transmitting	/
TM2	Receiving	/

Test Conditions	
Temperature:	25°C
Relative humidity:	45%
ATM Pressure:	101.9kPa

EUT Cable List and Details			
Cable Description	Length (m)	Shielded/Unshielded	With / Without Ferrite
USB Cable	0.95	Unshielded	Without Ferrite



6 Permitted Range of Operating Frequency

6.1 Standard Applicable

1. This applies to all WPT systems.

2. The permitted range of operating frequencies denotes the frequency ranges set out in Table 1. It likewise denotes the respective frequency range for accommodation of the fundamental WPT frequency of the EUT within its operating frequency range (OFR).

3. Limits

The permitted range of operating frequency range(s) for intentional emissions shall be within 19 - 21 kHz, 59 - 61 kHz, 79 - 90 kHz, 100 - 300 kHz, 6 765 - 6 795 kHz, see Table 2.

6.2 Test Procedure

Please refer to ETSI EN 303 417 subclause 6.2.2.

6.3 Test Result

Permitted range of operating frequencies				
F_L (kHz)	F_H (kHz)	Limit (kHz)		Result
110	205	$F_L \geq 100$	$F_H \leq 300$	Pass



7 Operating Frequency Ranges

7.1 Standard Applicable

The operating frequency range is the frequency range over which the WPT system is intentionally transmitting (all operational modes, see clause 4.2.3, Table 2).

The operating frequency range(s) of the WPT system are determined by the lowest (f_L) and highest frequency (f_H) as occupied by the power envelope.

The WPT system could have more than one operating frequency range.

For a single frequency systems the OFR is equal to the occupied bandwidth (OBW) of the WPT system.

For multi-frequency systems the OFR is described in Figures 2 and 3.

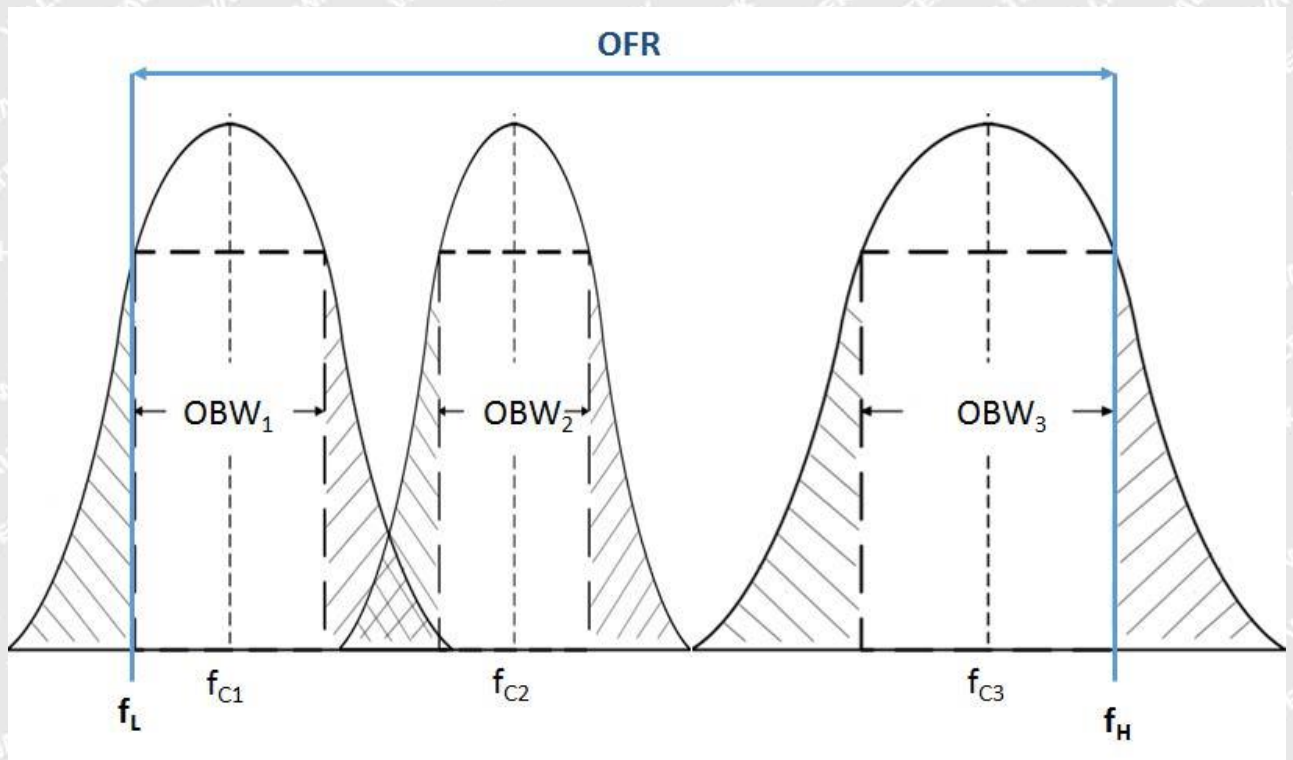

Figure 2: OFR of a multi - frequency WPT system within one frequency range of Table 2 and within one WPT system cycle time

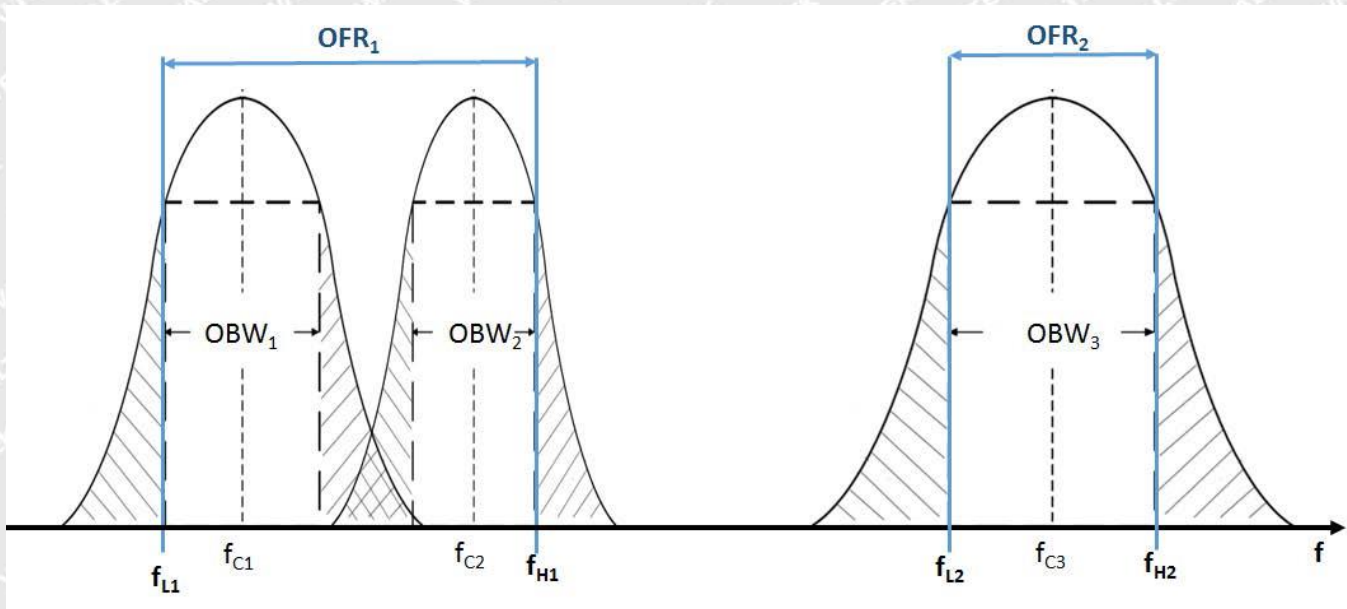

Figure 3: OFR of a multi - frequency WPT system within two frequency ranges of Table 2 and within one WPT system cycle time

Limits

The operating frequency range for emissions shall be within one of the following limits: 19 - 21 kHz, 59 - 61 kHz, 79 - 90 kHz, 100 - 300 kHz, 6 765 - 6 795 kHz.

7.2 Test Procedure

Please refer to ETSI EN 303 417 subclause 6.2.2.

7.3 Test Result

Operating frequency range(s) (OFR)				
F_L (kHz)	F_H (kHz)	Limit (kHz)		Result
148.35	149.43	$F_L \geq 100$	$F_H \leq 300$	Pass



Test Plots:

Operating frequency range(s) (OFR)

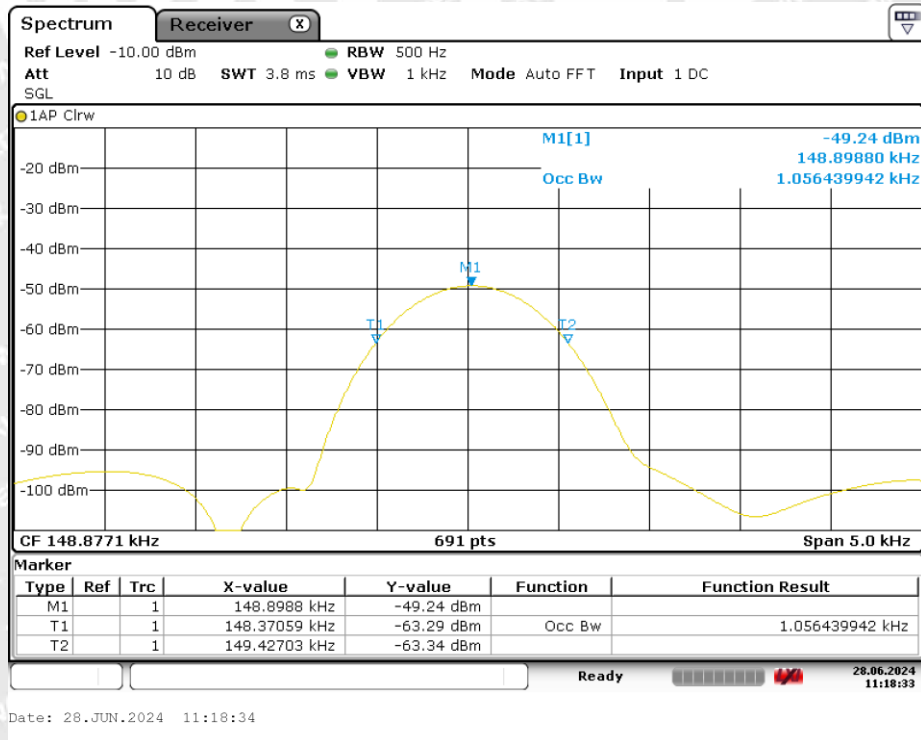
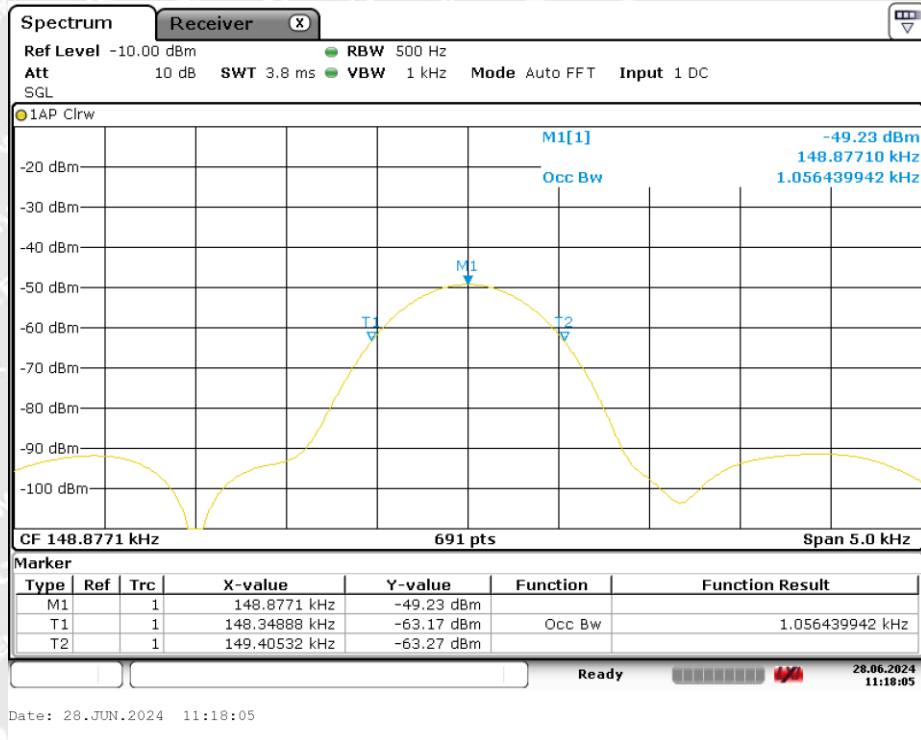



8 Transmitter H-field Requirements

8.1 Standard Applicable

The radiated H-field is defined in the direction of maximum field strength under specified conditions of measurement.

The H-field limits are provided in Table 3.

They have been specified for control of any radiated emissions within the OFR originating from the WPT system (power transmission and accompanying data communication).

The H-field limits in Table 3 are EU wide harmonised according to EC Decision 2013/752/EU [i.2]. Further information is available in CEPT/ERC/REC 70-03 [i.1].

Table 3: H-field limits

Frequency range [MHz]	H-field strength limit [dB μ A/m at 10 m]	Comments
$0,019 \leq f < 0,021$	72	
$0,059 \leq f < 0,061$	69,1 descending 10 dB/dec above 0,059 MHz	See note 1
$0,079 \leq f < 0,090$	67,8 descending 10 dB/dec above 0,079 MHz	See note 2
$0,100 \leq f < 0,119$	42	
$0,119 \leq f < 0,135$	66 descending 10 dB/dec above 0,119 MHz	See note 1
$0,135 \leq f < 0,140$	42	
$0,140 \leq f < 0,1485$	37,7	
$0,1485 \leq f < 0,30$	-5	
$6,765 \leq f < 6,795$	42	

NOTE 1: Limit is 42 dB μ A/m for the following spot frequencies: 60 kHz \pm 250 Hz and 129,1 kHz \pm 500 Hz.
 NOTE 2: At the time of preparation of the present document the feasibility of increased limits for high power wireless power transmission systems to charge vehicles [i.4] was prepared. New specific requirements for such systems (e.g. higher H-field emission limits in the 79 - 90 kHz band) will be reflected within a future revision of the present document.

8.2 Test Procedure

Please refer to ETSI EN 303 417 subclause 6.2.2

8.3 Test Result

Pre-scan EUT X,Y,Z axis, and find the worst case at X axis.

Frequency (MHz)	Level (dB μ A/m)@3m	C ₃ Factor (dB)	Level (dB μ A/m)@10m	Limit (dB μ A/m)@10m	Result
0.15	24.45	31.2	-6.75	-5	Pass

Note 1: $H_{3m} = H_{10m} + C_3$ refer to ETSI EN 300 330 Annex H.2



9 Transmitter Spurious Emissions

9.1 Standard Applicable

The transmitter spurious emissions for a single frequency system are to be considered in frequency ranges defined in Figure 4 ($f < f_{SL}$ and $f > f_{SH}$).

Figure 4: Out of band and spurious domain of a single frequency WPT system.

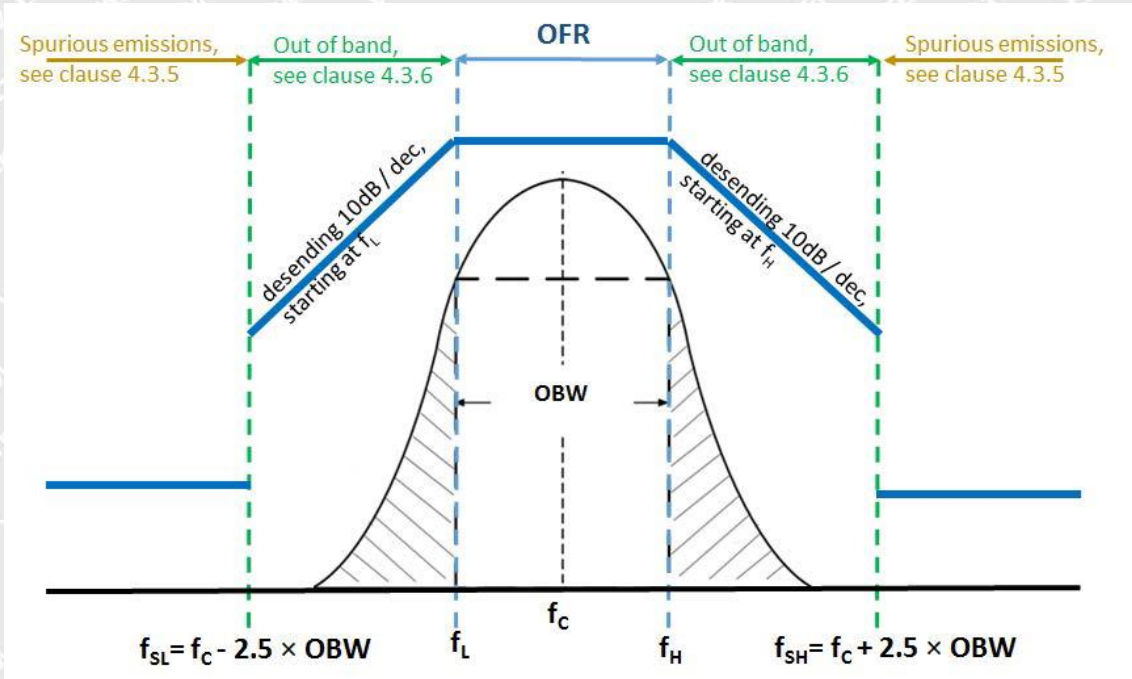

The transmitter spurious emissions for a multi frequency system (within one WPT frequency range from Table 2) are to be considered in frequency ranges defined in Figure 5 ($f < f_{SL}$ and $f > f_{SH}$).

Figure 5: Out of band and spurious domain of a multi - frequency system (during one WPT system cycle time).

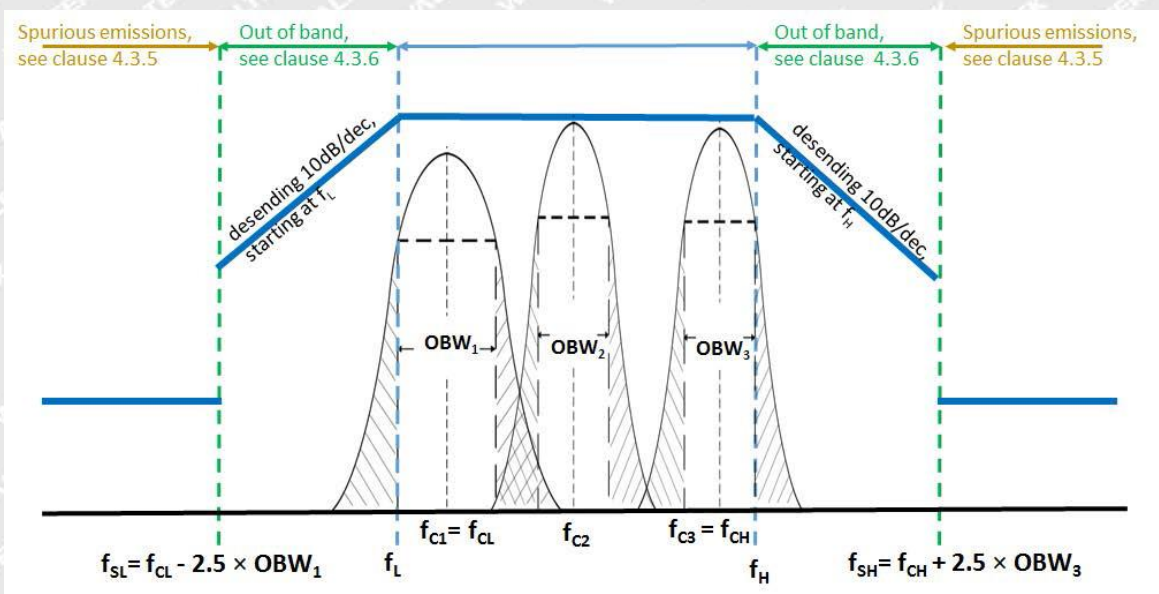



Limit

The radiated field strength of spurious emissions below 30 MHz shall not exceed the generated H-field given in Table 4.

State (see note)	Frequency 9 kHz ≤ f < 10 MHz	Frequency 10 MHz ≤ f < 30 MHz
Operating	27 dBμA/m at 9 kHz descending 10 dB/dec	-3,5 dBμA/m
Standby	5,5 dBμA/m at 9 kHz descending 10 dB/dec	-25 dBμA/m

NOTE: "Operating" means mode 2, 3 and 4 according to Table 2; "standby" means mode 1 according to Table 2.

The power of any radiated spurious emission between 30 MHz and 1 GHz shall not exceed the values given in Table 5.

State (see note)	47 MHz to 74 MHz 87,5 MHz to 118 MHz 174 MHz to 230 MHz 470 MHz to 790 MHz	Other frequencies between 30 MHz to 1 000 MHz
Operating	4 nW	250 nW
Standby	2 nW	2 nW

NOTE: "Operating" means mode 2, 3 and 4 according to Table 2; "standby" means mode 1 according to Table 2.

9.2 Test Procedure

Please refer to ETSI EN 303 417 subclause 6.2.2 and subclause 6.2.3 for the measurement method



9.3 Test Result

Pre-scan EUT X,Y,Z axis,and find the worst case at X axis.

9kHz-150kHz Emission @3m

Vertical Polarization

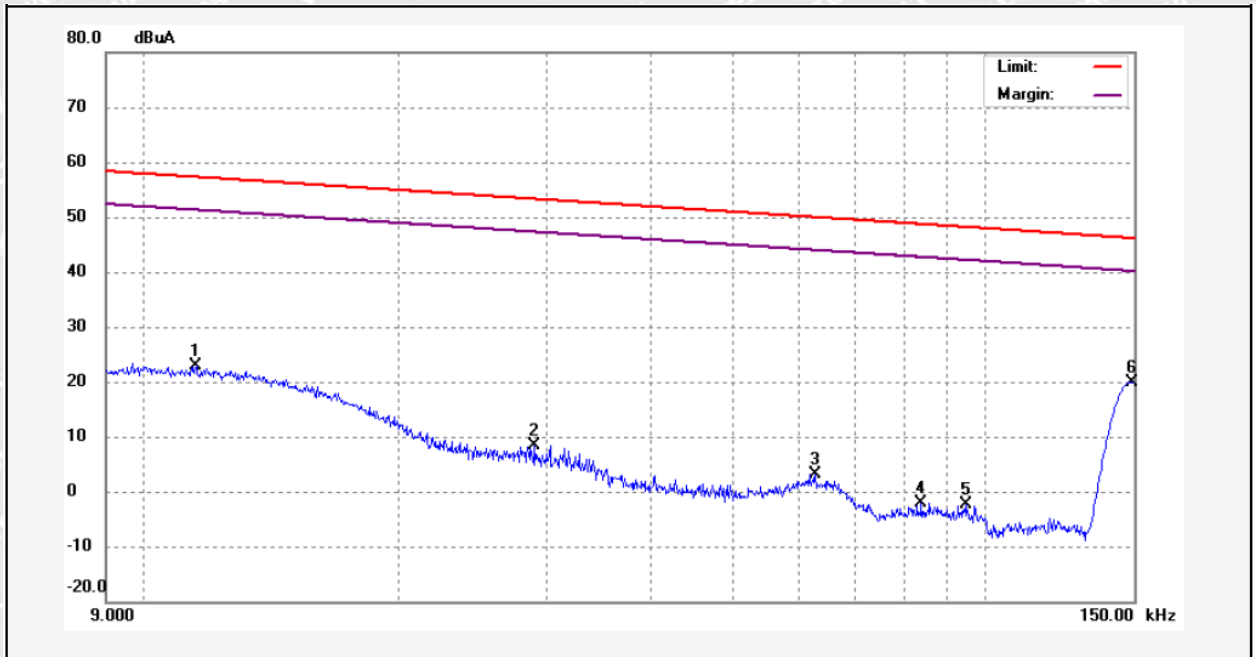

No.	Freq. (MHz)	Reading (dBuA)	Factor (dB)	Result (dBuA)	Limit (dBuA)	Margin (dB)	Detector	Remark
1	0.0115	24.88	-2.06	22.82	57.29	-34.47	peak	
2	0.0291	10.36	-1.89	8.47	53.28	-44.81	peak	
3	0.0628	5.54	-2.31	3.23	49.95	-46.72	peak	
4	0.0838	0.18	-2.35	-2.17	48.70	-50.87	peak	
5	0.0947	0.04	-2.29	-2.25	48.17	-50.42	peak	
6	0.1491	22.20	-2.24	19.96	46.16	-26.20	peak	

Note 1: $H_{3m} = H_{10m} + C_3$ refer to ETSI EN 300 330 Annex H.2



Horizontal Polarization

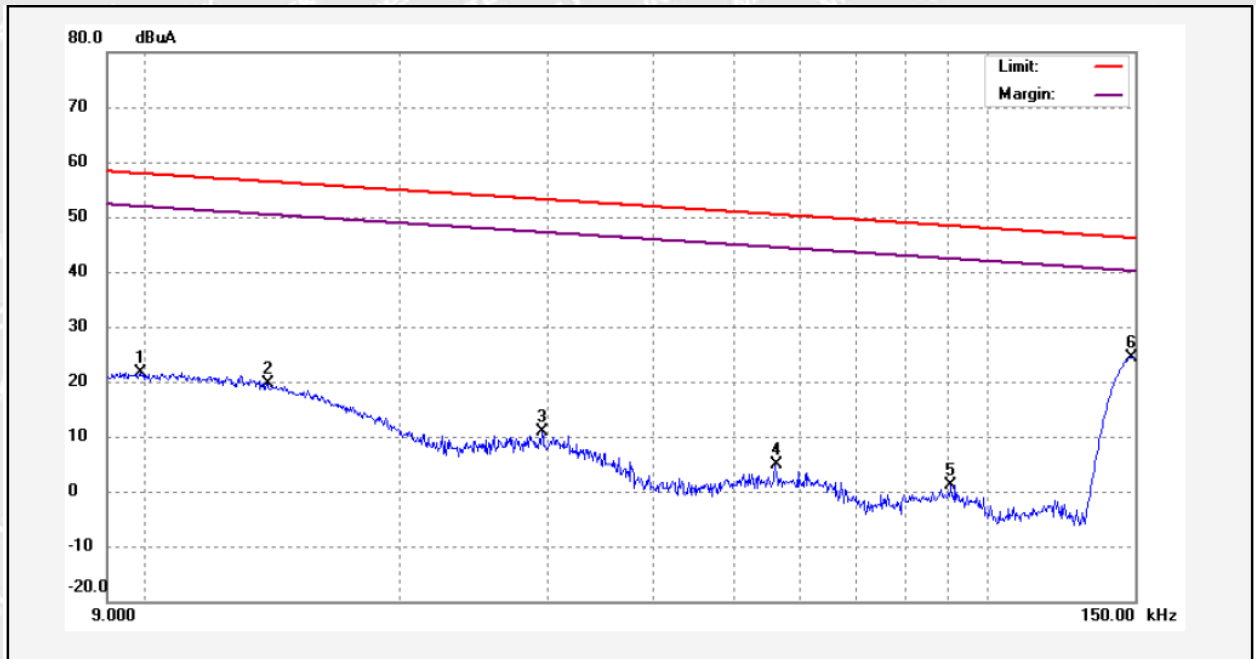

No.	Freq. (MHz)	Reading (dBuA)	Factor (dB)	Result (dBuA)	Limit (dBuA)	Margin (dB)	Detector	Remark
1	0.0098	23.77	-2.07	21.70	57.94	-36.24	peak	
2	0.0139	21.77	-2.03	19.74	56.43	-36.69	peak	
3	0.0296	12.71	-1.88	10.83	53.18	-42.35	peak	
4	0.0561	7.14	-2.29	4.85	50.43	-45.58	peak	
5	0.0907	3.55	-2.31	1.24	48.36	-47.12	peak	
6	0.1488	26.69	-2.24	24.45	46.17	-21.72	peak	

Note 1: $H_{3m} = H_{10m} + C_3$ refer to ETSI EN 300 330 Annex H.2



150kHz-30MHz Emission @3m

Vertical Polarization

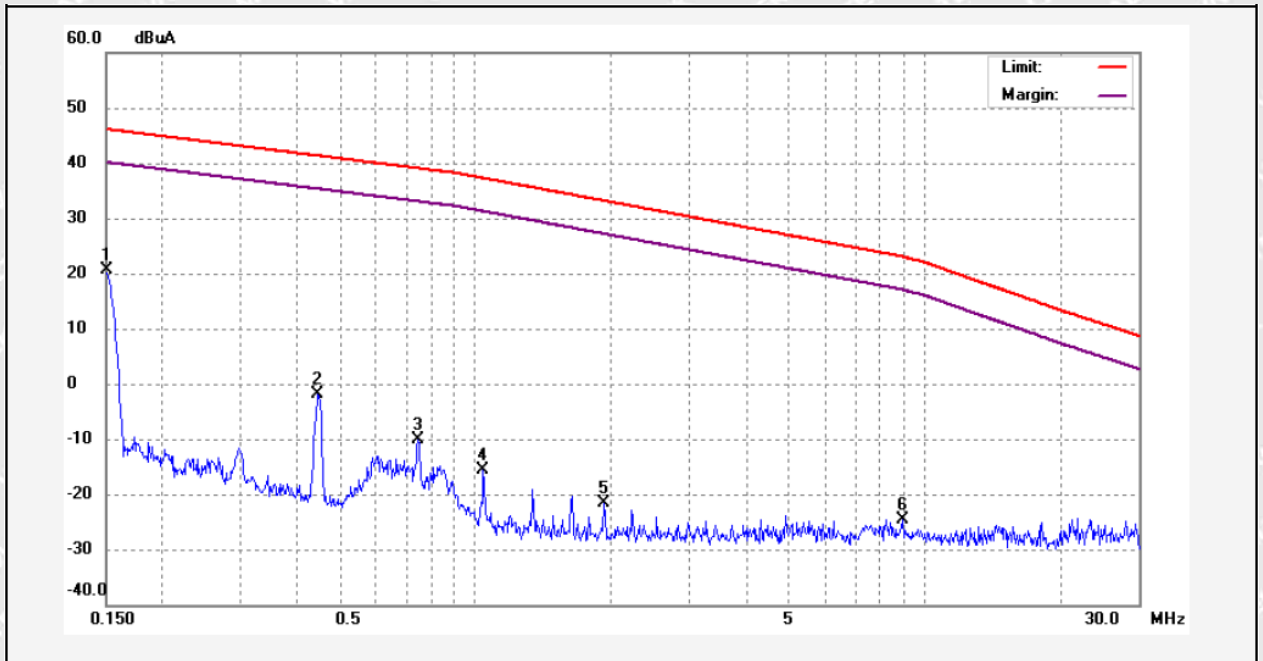

No.	Freq. (MHz)	Reading (dBuA)	Factor (dB)	Result (dBuA)	Limit (dBuA)	Margin (dB)	Detector	Remark
1	0.1500	22.77	-2.24	20.53	46.13	-25.60	peak	
2	0.4466	0.38	-2.30	-1.92	41.30	-43.22	peak	
3	0.7450	-7.73	-2.51	-10.24	39.04	-49.28	peak	
4	1.0413	-13.41	-2.24	-15.65	37.24	-52.89	peak	
5	1.9365	-19.41	-2.31	-21.72	33.14	-54.86	peak	
6	8.9305	-22.28	-2.26	-24.54	23.05	-47.59	peak	

Note 1: $H_{3m} = H_{10m} + C_3$ refer to ETSI EN 300 330 Annex H.2



Horizontal Polarization

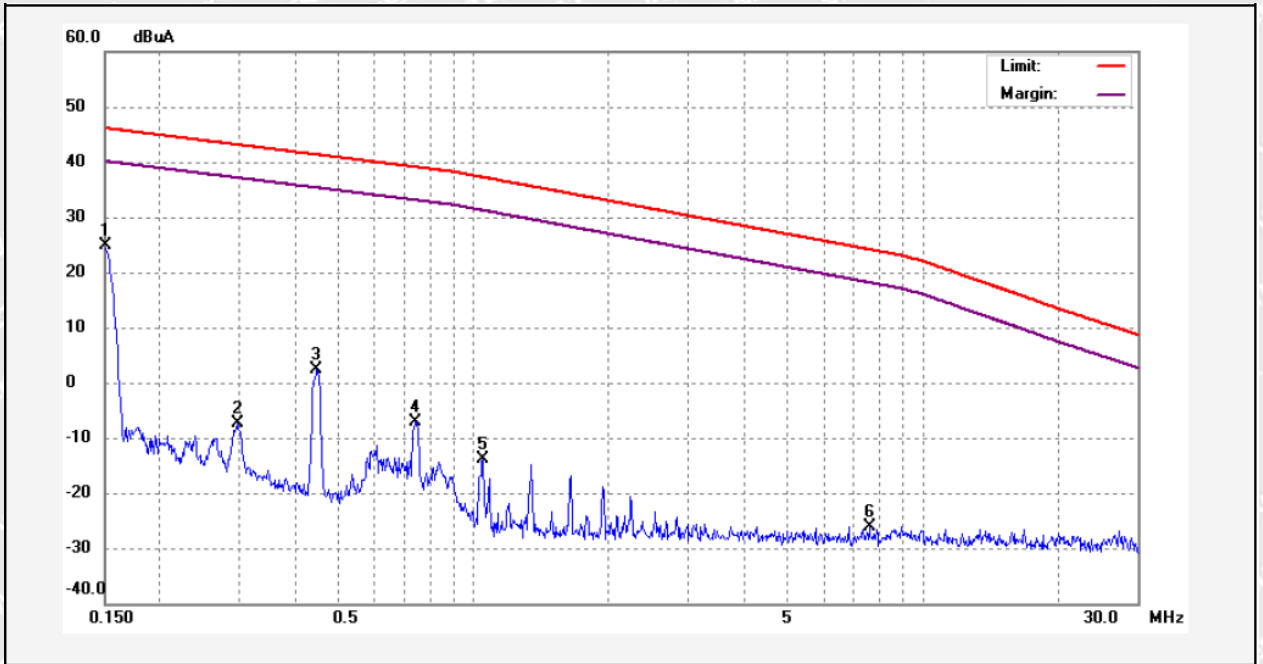

No.	Freq. (MHz)	Reading (dBuA)	Factor (dB)	Result (dBuA)	Limit (dBuA)	Margin (dB)	Detector	Remark
1	0.1500	27.17	-2.24	24.93	46.13	-21.20	peak	
2	0.2970	-5.30	-2.16	-7.46	43.11	-50.57	peak	
3	0.4466	4.71	-2.30	2.41	41.30	-38.89	peak	
4	0.7403	-4.64	-2.51	-7.15	39.06	-46.21	peak	
5	1.0430	-11.70	-2.24	-13.94	37.23	-51.17	peak	
6	7.5698	-23.67	-2.40	-26.07	24.14	-50.21	peak	

Note 1: $H_{3m} = H_{10m} + C_3$ refer to ETSI EN 300 330 Annex H.2



30MHz-1GHz Emission For TX

Vertical Polarization

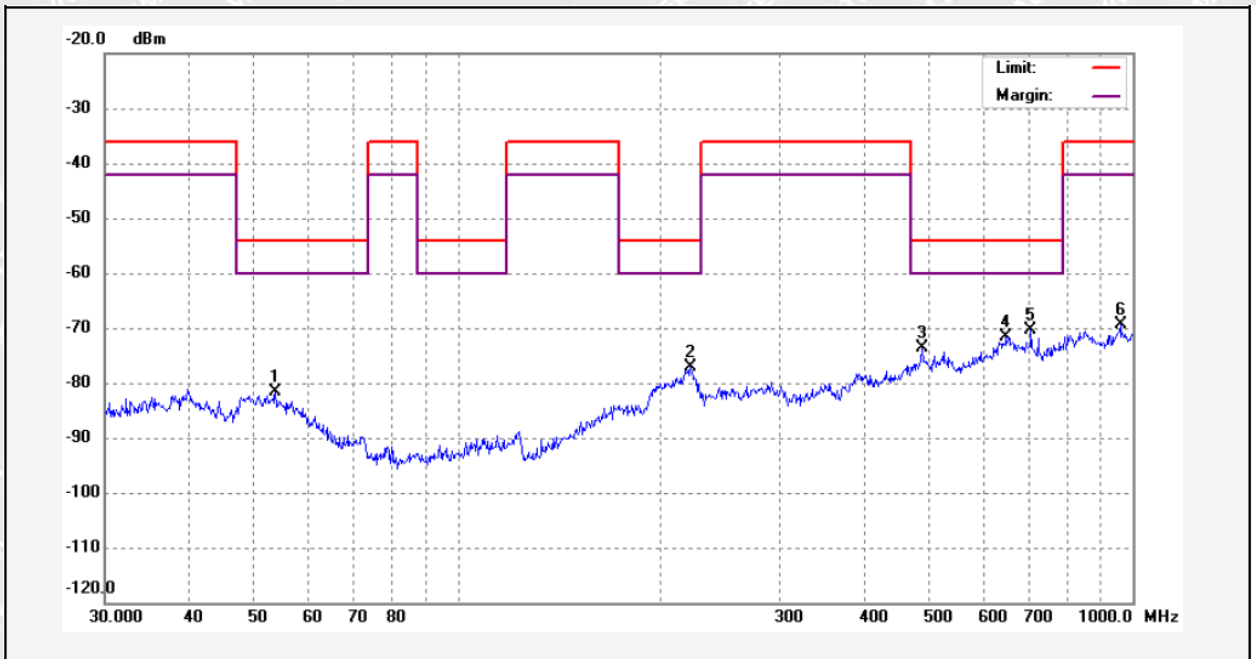

No.	Freq. (MHz)	Reading (dBm)	Factor (dB)	Result (dBm)	Limit (dBm)	Margin (dB)	Detector	Remark
1	53.6932	-106.35	24.80	-81.55	-54.00	-27.55	peak	
2	221.3921	-106.23	29.06	-77.17	-54.00	-23.17	peak	
3	487.3151	-104.35	30.74	-73.61	-54.00	-19.61	peak	
4	649.6597	-105.69	34.08	-71.61	-54.00	-17.61	peak	
5	706.6999	-102.74	32.43	-70.31	-54.00	-16.31	peak	
6	958.7943	-104.33	34.87	-69.46	-36.00	-33.46	peak	



Horizontal Polarization

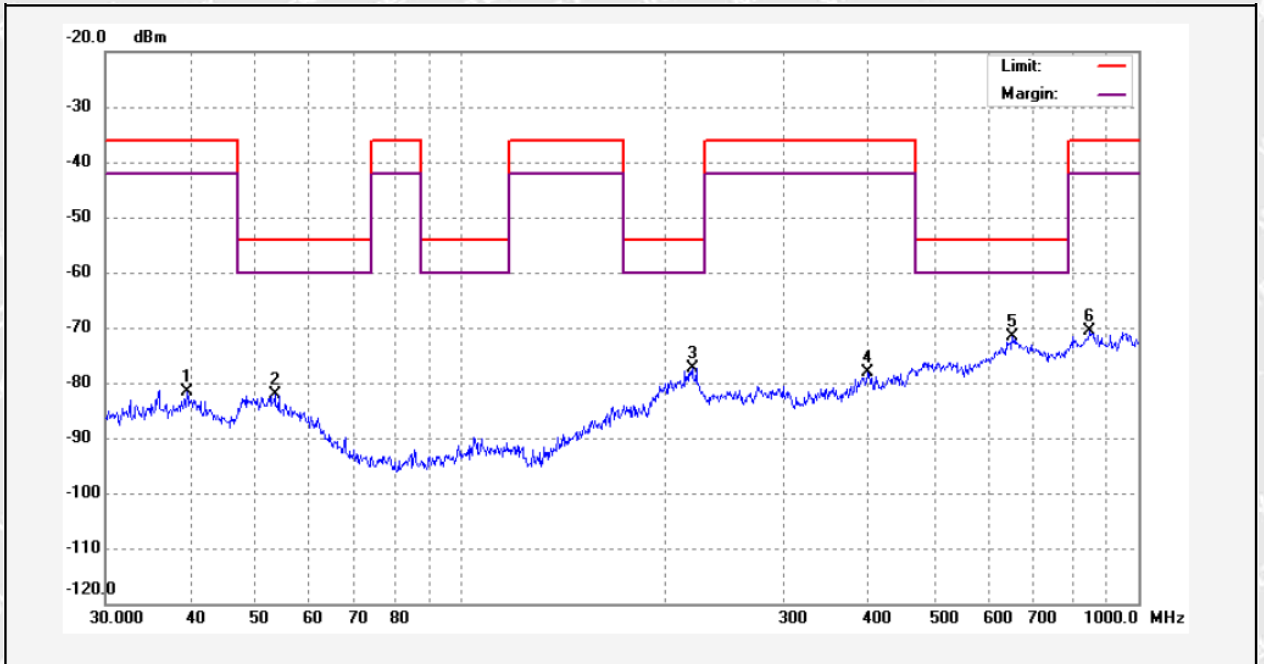

No.	Freq. (MHz)	Reading (dBm)	Factor (dB)	Result (dBm)	Limit (dBm)	Margin (dB)	Detector	Remark
1	39.5757	-106.74	25.22	-81.52	-36.00	-45.52	peak	
2	53.3179	-107.04	24.91	-82.13	-54.00	-28.13	peak	
3	219.8448	-106.94	29.69	-77.25	-54.00	-23.25	peak	
4	399.0302	-106.64	28.57	-78.07	-36.00	-42.07	peak	
5	651.9417	-105.57	33.99	-71.58	-54.00	-17.58	peak	
6	848.0563	-106.17	35.63	-70.54	-36.00	-34.54	peak	



30MHz-1GHz Emission For RX

Vertical Polarization

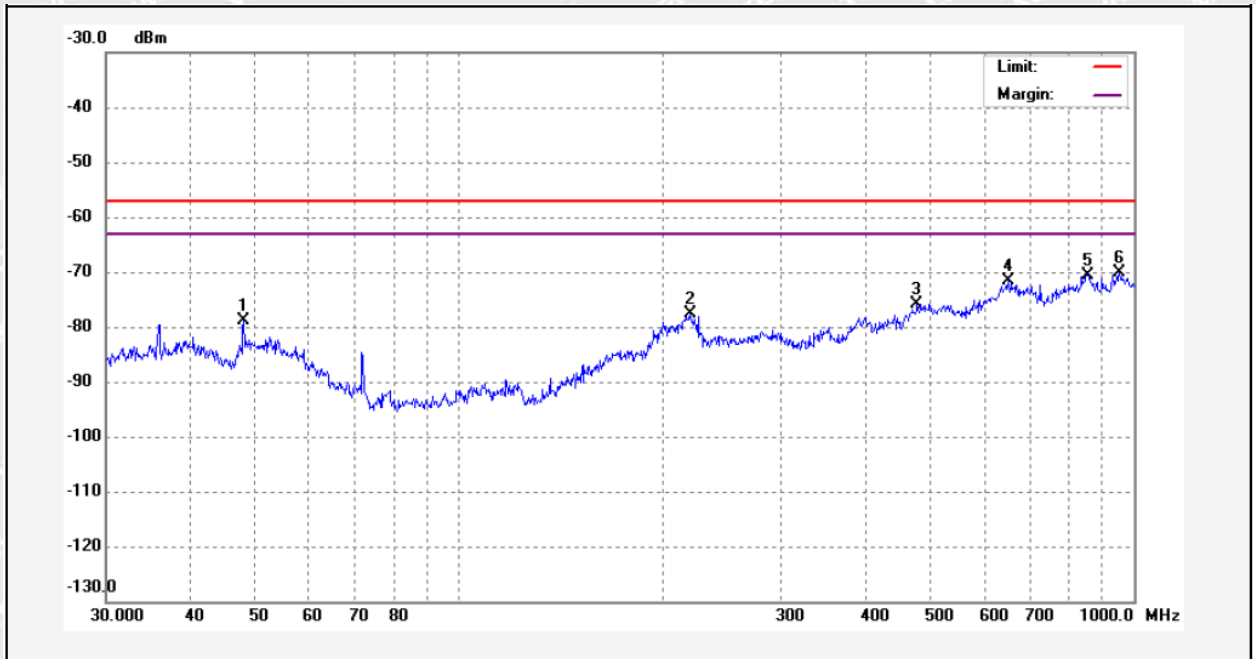

No.	Freq. (MHz)	Reading (dBm)	Factor (dB)	Result (dBm)	Limit (dBm)	Margin (dB)	Detector	Remark
1	47.9940	-103.47	24.54	-78.93	-57.00	-21.93	peak	
2	219.8449	-107.26	29.69	-77.57	-57.00	-20.57	peak	
3	477.1694	-106.10	30.22	-75.88	-57.00	-18.88	peak	
4	651.9417	-105.73	33.99	-71.74	-57.00	-14.74	peak	
5	854.0247	-105.98	35.39	-70.59	-57.00	-13.59	peak	
6	952.0937	-105.38	35.15	-70.23	-57.00	-13.23	peak	



Horizontal Polarization

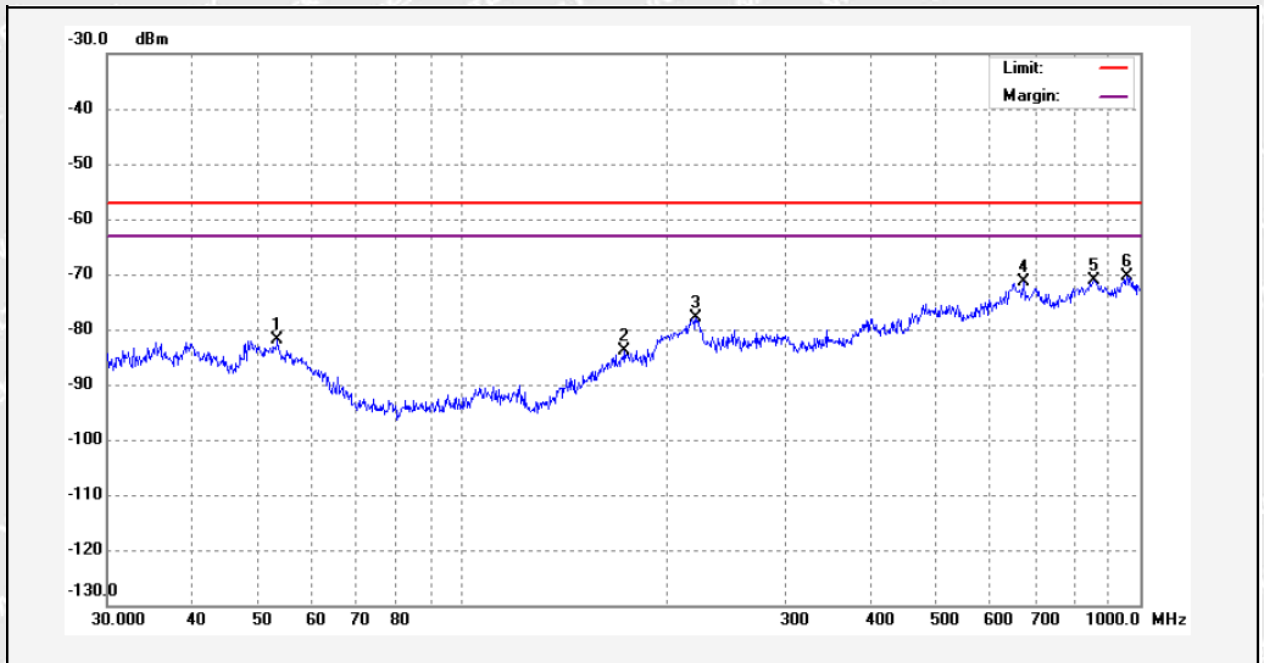

No.	Freq. (MHz)	Reading (dBm)	Factor (dB)	Result (dBm)	Limit (dBm)	Margin (dB)	Detector	Remark
1	53.5052	-106.82	24.86	-81.96	-57.00	-24.96	peak	
2	173.8135	-107.09	23.20	-83.89	-57.00	-26.89	peak	
3	221.3921	-107.03	29.06	-77.97	-57.00	-20.97	peak	
4	672.8444	-104.25	32.83	-71.42	-57.00	-14.42	peak	
5	854.0247	-106.57	35.39	-71.18	-57.00	-14.18	peak	
6	955.4381	-105.38	35.01	-70.37	-57.00	-13.37	peak	

Note1: Standby mode dose not produce any emission, which no emission been detected.



10 Transmitter Out of Band(OOB) Emissions

10.1 Standard Applicable

The WPT system out of band emissions are to be considered in frequency ranges defined in Figure 4 and Figure 5 (between f_{sL} and f_L and between f_H and f_{sH}).

Limit

The OOB limits are visualized in Figures 4 and 5; they are descending from the intentional limits from Table 3 at f_H/f_L with 10 dB/decade.

10.2 Test Procedure

Please refer to ETSI EN 303 417 subclause 6.2.2 for the measurement method

10.3 Test Result

No.	Frequency	Result@3m	C_3	Result@10	Limit@10	Margin	Remark
	(MHz)	(dBuA/m)	(dB)	(dBuA/m)	(dBuA/m)	(dB)	
1	$F_{cL}-2.5 \times OBW_1$	22.73	31.2	-8.47	-5	-3.47	peak
2	F_L	24.36	31.2	-6.84	-5	-1.84	peak
3	F_H	24.38	31.2	-6.82	-5	-1.82	peak
4	$F_{cH}+2.5 \times OBW_3$	22.62	31.2	-8.58	-5	-3.58	peak

Note 1: $H_{3m}=H_{10m}+C_3$ refer to ETSI EN300 330 Annex H.2



11 Receiver Blocking

11.1 Standard Applicable

This requirement applies to all WPT systems operation in Mode 1, Mode 2 and Mode 3.

Blocking is a measure of the capability of the receiver to receive a wanted signal without exceeding a given degradation due to the presence of an unwanted input signal at any frequencies other than those of the receiver spurious responses.

The test shall be performed in the relevant operational modes (see clause 4.2.3).

The wanted performance criteria from clause 4.2.2 shall be used as criterion for the receiver blocking tests.

Limit

Table 6: Receiver blocking limits

	In-band signal	OOB signal	Remote-band signal
Frequency	Centre frequency (f_c) of the WPT system (see clause 4.3.3)	$f = f_c \pm F$ (see note)	$f = f_c \pm 10 \times F$ (see note)
Signal level field strength at the EUT	72 dB μ A/m	72 dB μ A/m	82 dB μ A/m

NOTE: $F = \text{OFR}$ see clause 4.3.3.

The EUT shall achieve the wanted performance criterion, see clause 4.2.2, in the presence of the blocking signal.

11.2 Test Procedure

Please refer to ETSI EN 303 417 Sub-clause 6.2.3 for the measurement method

11.3 Test Result

Test Frequency	Blocking Signal(dBuA/m)	Performance Criterion	Result
$f_c - 10 \times \text{OFR}$	82	without degradation of performance	Pass
$F_c + \text{OFR}$	72	without degradation of performance	Pass
F_c	72	without degradation of performance	Pass
$F_c + \text{OFR}$	72	without degradation of performance	Pass
$f_c + 10 \times \text{OFR}$	82	without degradation of performance	Pass



12 Photographs – Test Setup

12.1 Photograph – Spurious Emissions Test Setup

9kHz to 30MHz



30MHz to 1GHz





13 Photographs – EUT Constructional Details

Please refer to “ANNEX”.

=====End of Report=====

WALTEK



中国认可
国际互认
检测
TESTING
CNAS L6478



TEST REPORT

Reference No. : WTF24F05107651W003
 Applicant..... : Mid Ocean Brands B.V.
 Address..... : 7/F., Kings Tower, 111 King Lam Street, Cheung Sha Wan, Kowloon, Hong Kong
 Manufacturer : 117486
 Address..... : ---
 Product Name..... : Wireless multi 4 in 1 speaker
 Model No..... : MO2378
 Test specification..... : EN IEC 62311:2020
 EN 50665:2017
 Date of Receipt sample : 2024-05-30
 Date of Test : 2024-06-28 to 2024-07-02
 Date of Issue..... : 2024-07-09
 Test Report Form No. : WEW-62311A-01B
 Test Result..... : **Pass**

Remarks:

The results shown in this test report refer only to the sample(s) tested, this test report cannot be reproduced, except in full, without prior written permission of the company. The report would be invalid without specific stamp of test institute and the signatures of approver.

Prepared By:

Waltek Testing Group (Foshan) Co., Ltd.

Address: 1/F., Building 19, Sunlink Machinery City, Xingye 4 Road,
 Guanglong Industrial Park, Chihua Neighborhood Committee, Chencun Town,
 Shunde District, Foshan, Guangdong, China

Tel:+86-757-23811398 Fax:+86-757-23811381 E-mail:info@waltek.com.cn

Tested by:

Approved by:

Roy Hong

Danny Zhou



1 Test Summary

HEALTH			
Test	Test Method	Class / Severity	Result
RF Exposure	EN IEC 62311:2020 EN 50665:2017	-	Pass

Remark:

Pass Test item meets the requirement

N/A Not Applicable

WALTEK



2 Contents

	Page
1 TEST SUMMARY	2
2 CONTENTS	3
3 GENERAL INFORMATION	4
3.1 GENERAL DESCRIPTION OF E.U.T.	4
3.2 TECHNICAL SPECIFICATION OF BT.....	4
3.3 TECHNICAL SPECIFICATION OF WPT.....	4
3.4 STANDARDS APPLICABLE.....	4
4 HEALTH REQUIREMENTS	5
4.1 RF EXPOSURE EVALUATIONS	6
4.2 RF EXPOSURE TEST PROCEDURE.....	6
4.3 TEST RESULT OF RF EXPOSURE EVALUATION.....	6
5 PHOTOGRAPHS – EUT CONSTRUCTIONAL DETAILS	7

WALTEK



3 General Information

3.1 General Description of E.U.T.

Product Name	: Wireless multi 4 in 1 speaker
Model No.	: MO2378
Remark	: ---
Rated Voltage.....	: Type-C Input: DC 5V, 3A or DC 9V, 3A Wireless output: 15W Max.
Battery Capacity	: 1200mAh
Adapter Model.....	: ---

3.2 Technical Specification of BT

Bluetooth Version	: Bluetooth V5.3 (BR+EDR)
Frequency Range	: 2402-2480MHz
Maximum RF Output Power	: -2.41 dBm (EIRP)
Type of Modulation	: GFSK, $\pi/4$ QPSK, 8DPSK
Data Rate	: 1Mbps, 2Mbps, 3Mbps
Quantity of Channels	: 79
Channel Separation.....	: 1MHz
Antenna Type.....	: PCB Antenna
Antenna Gain	: 0dBi

3.3 Technical Specification of WPT

Frequency Bands	: 110-205kHz
Radiated H-Field	: 24.45 dBuA/m(@3m)
Antenna installation	: Coil Antenna

3.4 Standards Applicable

The tests were performed according to following standards:

EN IEC 62311:2020	Assessment of electronic and electrical equipment related to human exposure restrictions for electromagnetic fields (0 Hz - 300 GHz)
EN 50665:2017	Generic standard for assessment of electronic and electrical equipment related to human exposure restrictions for electromagnetic fields (0 Hz - 300 GHz).



4 Health Requirements

According to Council Recommendation: the criteria listed in the following table shall be used to evaluate the environment impact of human exposure to radio frequency (RF) radiation.

Reference levels for electric, magnetic and electromagnetic fields (0Hz to 300GHz, unperturbed RMS values)

Frequency range	E-field strength (V/m)	H-field strength (A/m)	B-field (μT)	Equivalent plane wave power density Seq (W/m ²)
0-1 Hz	-	3.2×10^4	4×10^4	-
1-8 Hz	10000	$3.2 \times 10^4 / f^2$	$4 \times 10^4 / f^2$	-
8-25 Hz	10000	$4000 / f$	$5000 / f$	-
0.025-0.8 kHz	$250 / f$	$4 / f$	$5 / f$	-
0.8-3 kHz	$250 / f$	5	6.25	-
3-150 kHz	87	5	6.25	-
0.15-1 MHz	87	$0.73 / f$	$0.92 / f$	-
1-10 MHz	$87 / f^{1/2}$	$0.73 / f$	$0.92 / f$	-
10-400 MHz	28	0.073	0.095	2
400-2000 MHz	$1.375 f^{1/2}$	$0.0037 f^{1/2}$	$0.0046 f^{1/2}$	$f / 200$
2-300 GHz	61	0.16	0.2	10

Note:

1. f as indicated in the frequency range column.
2. For frequencies between 100 kHz and 10 GHz, Seq, E2, H2 and B2 are to be averaged over any six-minute period.
3. For frequencies exceeding 10 GHz, Seq, E2, H2 and B2 are to be averaged over any $68 / f^{1.05}$ minute period (f in GHz).
4. No E-field value is provided for frequencies < 1 Hz, which are effectively static electric fields. For most people the annoying perception of surface electric charges will not occur at field strengths less than 25 kV/m. Spark discharges causing stress or annoyance should be avoided.



4.1 RF Exposure Evaluations

$$E = \sqrt{30PG_{(\theta,\phi)}} / r$$

Antenna gain in numeric (G):

10[^] (Antenna gain in dBi /10)

Distance from EUT to Human (r):

0.20 m

4.2 RF Exposure test procedure

Software provided by client enabled the EUT to transmit and receive data at lowest, middle and highest channel individually.

4.3 Test Result of RF Exposure Evaluation

The antenna of the product, under normal use condition is at least 20 cm away from the body of the user. Warning statement to the user to keeping at least 20 cm separation distance and the prohibition of operating to a person has been printed on the user's manual. So, this product under normal use is located on electromagnetic far field between the human body.

RF Exposure For BT							
Test Mode	Antenna Gain (dBi)	Antenna Gain (Numeric)	Maximum Output Power (dBm)	Maximum Output Power (W)	E Field Strength (V/m)	E Field Strength Limit (V/m)	Result
BT	0	1.00	-2.41	0.0006	0.66	61	Pass
Remark: For details of output power please refer to report No. WTF24F05107651W001.							

Which is less than the limit, RF exposure assessment has been performed above to prove that this unit will not generate the harmful EM emission above the reference level as specified in EC Council Recommendation (1999/519/EC).

RF Exposure For WPT				
Frequency (kHz)	Radiated H-Field (dBμA/m)	Radiated H-Field (A/m)	Limit (A/m)	Result
172.8	25.37	0.00001856	5	Pass
Remark: For details of Radiated H-Field refer to report No. WTF24F05107651W002.				

Since average output power at worse case is: 0.00001856A/m which cannot exceed the exempt condition, 5A/m specified in EN IEC 62311. It is deemed to full fit the requirement of RF exposure basic restriction specified in EC Council Recommendation (1999/519/EC).



5 Photographs – EUT Constructional Details

Please refer to “ANNEX”.

=====End of Report=====

WALTEK