

TEST REPORT

Reference No. : SZ2024060068-1E

Date : Jun. 06, 2024

Page No.: 1 of 5

Client :

Address :

The following merchandise was (were) submitted and identified by the client as:

Name of Product : Battery

Test Model : 702040

Model May Cover : /

Main Material: /

Supplier: /

Buyer: /

Sample Received : Jun. 03, 2024

Test Period : Jun. 03, 2024 - Jun. 06, 2024

Test Specification and Conclusion:

Total Lead, Cadmium and Mercury content according to the Batteries Regulation-
Regulation (EU) 2023/1542

PASS

Prepared By :



David Chen
Testing Engineer

Reviewed By :

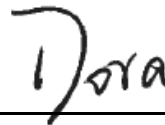

Dora Cheng
Reporter Supervisor

Issued By :



Ada Wang
Lab Manager



SZ2024060068-1E

STQ Testing Services Co., Ltd.

Add.: Building 1, 15 Yinzhu Road, High-new district, Suzhou, China 215129

Tel: +86/(0)512 67991866

Web: www.stq-cert.com

Technical service: TS@stq-cert.com

Customer service: CS@stq-cert.com

Report checking: Report@stq-cert.com

Complaint: QA@stq-cert.com

TEST REPORT

Reference No. : SZ2024060068-1E

Date : Jun. 06, 2024

Page No.: 2 of 5

TEST RESULTS:

Lead(Pb), Cadmium(Cd) and Mercury(Hg) Content

Test Method:

For Pb and Cd content: Analysis was performed by ICP-OES.

For Hg content: Analysis was performed by cold vapor atomic absorption spectrometry.

Test Item(s)	MDL (%)	Test Result(s) (%)	Labelling Requirement# (%)	Limited Value* (%)
		1#		
Pb	0.0005	N.D.	>0.004	0.01**
Cd	0.0005	N.D.	>0.002	0.002
Hg	0.0001	N.D.	---	0.0005

- Remark:**
- 1) #All batteries containing more than 0.002 % cadmium or more than 0.004 % lead, shall be marked with the chemical symbol for the metal concerned: Cd or Pb. The relevant chemical symbol indicating the heavy metal content shall be printed beneath the separate collection symbol as shown in Part B of Annex VI in Regulation (EU) 2023/1542 and shall cover an area of at least one-quarter the size of that symbol;
 - 2) --- = Not Regulated;
 - 3) *The limited value is based on Annex I of Regulation (EU) 2023/1542;
 - 4) **The limited value shall apply to portable batteries, whether or not incorporated into appliances from 18 August 2024 and not apply to portable zinc-air button cells until 18 August 2028.

- Note:**
- 1) MDL = Method Detection Limit;
 - 2) N.D. = Not detected, less than MDL.

Test Part Description:

1# Battery

***** To be continued *****

STQ Testing Services Co., Ltd.

Add.: Building 1, 15 Yinzhu Road, High-new district, Suzhou, China 215129

Tel: +86/(0)512 67991866

Web: www.stq-cert.com

Technical service: TS@stq-cert.com

Customer service: CS@stq-cert.com

Report checking: Report@stq-cert.com

Complaint: QA@stq-cert.com

TEST REPORT

Reference No. : SZ2024060068-1E

Date : Jun. 06, 2024

Page No.: 3 of 5

SAMPLE PHOTO******* END OF REPORT *******

STQ Testing Services Co., Ltd.

Add.: Building 1, 15 Yinzhu Road, High-new district, Suzhou, China 215129

Tel: +86/(0)512 67991866

Web: www.stq-cert.comTechnical service: TS@stq-cert.comCustomer service: CS@stq-cert.comReport checking: Report@stq-cert.comComplaint: QA@stq-cert.com



TEST REPORT

Reference No. : SZ2024060068-1E

Date : Jun. 06, 2024

Page No.: 4 of 5

GENERAL CONDITIONS OF SERVICES

STQ Testing Services Co.,Ltd. (hereinafter "STQ"), The testing or examining under the request of the customer should obey terms as follow, according to regulation of "Contract Law of the People's Republic of China" on processing and undertaking contract, our company have legal right of termination without any reason and have the right to accept or refuse testing or examining request:

1. STQ only acts for the person or body originating the instructions (the "Clients"). No other party is entitled to give instructions, particularly on the scope of testing or delivery of report or certificate, unless authorized by the Clients.
2. The delivery and return fee of the samples which need to do testing at STQ should be paid by the client. STQ will not bear the responsibility for the testing error that is caused by transporting, packaging and labelling.
3. Sample recycling: when the testing or examining is finished, the customer should recycle the sample. Within 30 days after issuing of testing report, if the customer could not recycle the sample or send notification of sample recycling in written (for example, if the sample belongs to consumables, toxic drugs, dangerous goods and other items that are not suitable for long-term storage, such as semi-finished products and fragile samples such as liquids and powders, the retention period will be shortened to 7 days). After the retention period, STQ has the right to dispose of the sample arbitrarily without paying compensation or compensation to the customer and take no responsibility for the consequences that damages the customer's trade secrets and intellectual property rights due to the loss of the sample.
4. The Clients shall always comply with the following before or during STQ providing its services:
 - a) provide sample(s) and relevant data, at the same time, guarantee the consistence of the sample(s)' name they declared with the sample(s) or the goods provided. Otherwise, STQ will not bear any relevant responsibilities;
 - b) giving timely instructions and adequate information to enable STQ to perform the services effectively;
 - c) supply, when requested by STQ, any equipment and personnel for the performance of the services;
 - d) take all necessary steps to eliminate or remedy any obstruction in the performance of the services;
 - e) inform STQ in advance of any hazards or dangers, actual or potential, associated with any order of samples or testing;
 - f) provide all necessary access for STQ's representative to enable the required services to be performed effectively;
 - g) ensure all essential steps are taken for safety of working conditions, sites and installations during the performance of services;
 - h) fully discharge all its liabilities under any contract like sales contract with a third party, whether or not a report or certificate has been issued by STQ, failing which STQ shall be under no obligation to the Clients.
5. Subject to STQ's accepting the Client's instructions, STQ will issue reports or certificates which reflect statements of opinion made with due care within the scope of instructions but STQ is not obliged to report upon any facts outside the instructions, if there were any dissidence about the report or certificate, the Client should provide the written declaration to STQ within 15 days after the date receiving the report or certificate, otherwise, STQ will not hear the case after the date limit.
6. STQ is irrevocably authorized by the Clients to deliver at its discretion the report or the certificate to any third party when instructed by the Clients or where it implicitly follows from circumstances, trade custom, usage or practice as determined by STQ.
7. A test report will be issued in confidence to the Clients and it will be strictly treated as such by STQ. It may not be reproduced either in its entirety or in part and it may not be used for advertising or other unauthorized purposes without the written consent of STQ. The Clients to whom the Report is issued may, however, show or send it, or a certified copy thereof prepared by STQ, to his customer, supplier or other persons directly concerned. STQ will not, without the consent of the Clients, enter into any discussion or correspondence with any third party concerning the contents of the report unless required by the relevant governmental authorities, laws or court orders.
8. Applicants wishing to use STQ's reports in court proceedings or arbitration shall inform STQ to that effect prior to submitting the sample for testing.
9. The report will refer only to the sample tested and will not apply to the bulk, unless the sampling has been carried out by STQ and is stated as such in the Report. Also, the report is only for reference.
10. Any documents containing engagements between the Clients and third parties like contracts of sale, letters of credit, bills of lading, etc. are regarded as information for STQ only and do not affect the scope of the services or the obligations accepted by STQ.
11. If the Clients do not specify the methods/standards to be applied, STQ will choose the appropriate ones and further information regarding the methods can be obtained by direct contact with STQ, for the in-house method, STQ will only provide the summary.
12. No liability shall be incurred by and no claim shall be made against STQ or its servants, agents, employees or independent contractors in respect of any loss or damage to any such materials, equipment and property occurring whilst at STQ or any work places in which the testing is carried out, or in the course of transit to or from STQ or the said work places, whether or not resulting from any acts, neglect or default on the part of any such servants, agents, employees or independent contractors of STQ.
13. STQ will not be liable, or accept responsibility for any loss or damage howsoever arising from the use of information contained in any of its reports or in any communication whatsoever about its said tests or investigations.
14. Except for term 11 and term 12, if the test sample is damaged due to the negligence of STQ, the total compensation for loss and damage to the sample or loss to the customer shall not exceed twice of the test service fee.
15. In the event of STQ prevented by any cause outside STQ's control from performing any service for which an order has been given or an agreement made, the Clients shall pay to STQ:
 - a) the amount of all abortive expenditure actually made or incurred;

STQ Testing Services Co., Ltd.

Add.: Building 1, 15 Yinzhu Road, High-new district, Suzhou, China 215129

Tel: +86/(0)512 67991866

Web: www.stq-cert.com

Technical service: TS@stq-cert.com

Customer service: CS@stq-cert.com

Report checking: Report@stq-cert.com

Complaint: QA@stq-cert.com



TEST REPORT

Reference No. : SZ2024060068-1E

Date : Jun. 06, 2024

Page No.: 5 of 5

- b) a proportion of the agreed fee or commission equal to the proportion (if any) of the service actually carried out by STQ, and STQ shall be relieved of all responsibility whatsoever for the partial or total non-performance of the required service.
16. STQ shall be discharged from all liabilities for all claims for loss, damage or expense unless suit is brought within one calendar year after the date of the performance by STQ of the service relating to the claim or in the event of any alleged non-performance within one year of the date when such service should have been completed.
17. The Clients acknowledge that STQ does not, either by entering into a contract or by performing service, assume or undertake to discharge any duty of the Clients to any other persons. STQ is neither an insurer nor a guarantor and disclaims all liability in such capacity.
18. The Clients shall hold harmless and indemnify STQ and its officers, employees, agents or independent contractors against all claims made by any third party for loss, damage or expense of whatsoever nature including reasonable legal expenses relating to the performance or non-performance of any services to the extent that the aggregate of any such claims relating to any one service exceed the limits mentioned in Clause 13.
19. Any unauthorized alteration, forgery or falsification of the content or appearance of the report/certificate is unlawful and offenders may be prosecuted to the fullest extent of the law; in the event of improper use of the report, STQ reserves the right to withdraw it, and to adopt any other measures which may be appropriate.
20. Samples are deposited with and accepted by STQ on the basis that either they are insured by the Clients or the Clients assumes entire responsibility for loss through fire, theft, burglary or for damages arising in the course of analysis or handling, without recourse whatsoever to STQ or its servants, agent, employees or independent contractors.
21. If the requirements of the Clients require the analysis of samples by the Clients' or any third party's laboratory, STQ will only convey the result of the analysis without responsibility for its accuracy. If STQ is only able to witness an analysis by the Clients' or any third Party's laboratory STQ will only confirm that the correct sample has been analyzed without responsibility for the accuracy of any analysis or results.
22. In the event of any unforeseen additional time or costs being incurred in the course of carrying out any of its services, STQ shall be entitled to charge the Clients additional fees to reflect the additional time and costs incurred.
23. All rights (including but not limited to copyright) in any reports, certificates or other materials produced by STQ in the course of providing its services shall remain vested in STQ.
24. Unless otherwise agreed in written, payment should be arranged within 10 days after the invoice date or the debit note date. If the payment is overdue, the overdue penalty shall be calculated at 1% per day of the unpaid part till the actual payment date. All expenses, costs and losses incurred by STQ as a result of collecting or claiming the fees owed shall be borne by the customer, including but not limited to attorney fees, litigation fees, preservation fees, preservation guarantee fees, travel expenses, etc.
25. Test results may be transmitted by electronic means at the Client's request. However, it should be noted that electronic transmission cannot guarantee the information contained will not be lost, delayed or intercepted by third party. STQ is not liable for any disclosure, error or omission in the content of such messages as a result of electronic transmission.
26. If necessary, STQ may subcontract part of or all tests to competent subcontractors. If no objection is raised at the time of the Clients submitting the application, STQ shall assume the Client's approval.
27. This report/certificate does not relieve sellers/suppliers from their contractual responsibility with regards to the quality/quantity of this delivery nor does it prejudice the Client's right to claim towards sellers/suppliers for compensation for any apparent and/or hidden defects not detected during STQ's random inspection or testing or audit.
28. The testing data and result(s) in this reportis(are) just for scientific research, education, internal quality control and product development etc.
29. STQ reserves the right to include Special Conditions in addition to the foregoing General Conditions if warranted by the particular circumstances of the required test or investigation [this clause is only effective when the other party has been informed].
30. The foregoing General Conditions shall in all respects be governed, construed, interpreted and operated in accordance with the relevant Chinese laws and regulations. Unless otherwise agreed, the arbitration shall take place in P. R. C
31. These General Condition have been drafted in Chinese and may be translated into other languages. In the event of any discrepancy, the Chinese version shall prevail.
32. In general sample will be stored for 30 days. But for liquid, powder, etc semi-product & fragile product, it will be stored for 15 days after the report is issued.

STQ Testing Services Co., Ltd.

Add.: Building 1, 15 Yinzhu Road, High-new district, Suzhou, China 215129

Tel: +86/(0)512 67991866

Web: www.stq-cert.com

Technical service: TS@stq-cert.com

Customer service: CS@stq-cert.com

Report checking: Report@stq-cert.com

Complaint: QA@stq-cert.com

TEST REPORT IEC 62133-2 Secondary cells and batteries containing alkaline or other non-acid electrolytes – Safety requirements for portable sealed secondary cells, and for batteries made from them, for use in portable applications –Part 2: Lithium systems	
Report Number.....:	TSZ22070015-P01-R01
Date of issue.....:	2023-07-21
Total number of pages.....:	22
Name of Testing Laboratory preparing the Report.....:	Shenzhen Tiansu Calibration and Testing Co., Ltd.
Applicant's name.....:	
Address.....:	
Test specification:	
Standard.....:	IEC 62133-2:2017
General disclaimer:	
The test results presented in this report relate only to the object tested. This report shall not be reproduced, except in full, without the written approval of the Issuing Laboratory.	
Test item description.....:	Polymer Li-ion Rechargeable Battery
Trade Mark.....:	N/A
Manufacturer.....:	Same as applicant
Model/Type reference.....:	702040
Ratings.....:	3.7V, 500mAh, 1.85Wh
Responsible Testing Laboratory and testing location(s):	
<input checked="" type="checkbox"/> Testing Laboratory:	Shenzhen Tiansu Calibration and Testing Co., Ltd.
Testing location/ address.....:	Building 4, No.2, Jinlong Road, Longgang District, Shenzhen, Guangdong, China.
Tested by (name, function, signature).....:	Dragon Xu Test Engineer
Approved by (name, function, signature)...:	Duan jiang tao Technology supervisor



List of Attachments (including a total number of pages in each attachment):	
Attachment 1 (1 Page): Circuit diagram Attachment 2 (3 Pages): Product Photos	
Summary of testing:	
<p>Tests performed (name of test and test clause):</p> <p>Testing for cell: 702040</p> <p>7.2.1 Continuous charging at constant voltage (cells)</p> <p>7.3.1 External short-circuit (cell)</p> <p>7.3.3 Free fall</p> <p>7.3.4 Thermal abuse (cells)</p> <p>7.3.5 Crush (cells)</p> <p>7.3.7 Forced discharge (cells)</p> <p>7.3.9"※" Design evaluation – Forced internal short-circuit (cells)</p> <p>Testing for Battery: 702040</p> <p>7.2.2 Case stress at high ambient temperature (battery)</p> <p>7.3.2 External short-circuit (battery)</p> <p>7.3.3 Free fall</p> <p>7.3.6 Over-charging of battery</p> <p>7.3.8 Mechanical tests (batteries)</p> <p>7.3.8.1 Vibration</p> <p>7.3.8.2 Mechanical shock</p> <p>Tests are made with the number of in IEC 62133-2: 2017 Table 1.</p>	<p>Testing location:</p> <p>Shenzhen Tiansu Calibration and Testing Co., Ltd. Building 4, No.2, Jinlong Road, Longgang District, Shenzhen, Guangdong, China.</p>

Parameter with asterisk "※" is not within the accreditation by CNAS.

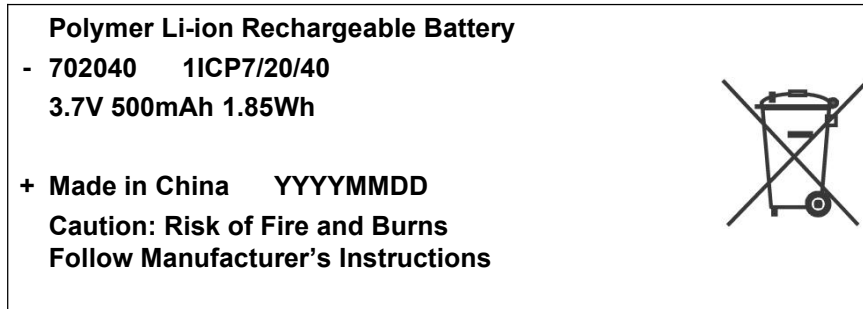
Copy of marking plate:**The artwork below may be only a draft.**

The sample is a small battery according to IEC 62133-2: 2017

cl. 8.2, the relevant requirements of the label will be described in the specification, including the product name, battery designation, manufacturer name and related warning "Keep small cells which are considered swallowable out of the reach of children. Swallowing may lead to burns, perforation of soft tissue, and death. Severe burns can occur within 2 h of ingestion. In case of ingestion of a cell or battery, seek medical assistance promptly.", "caution for batteries which are considered swallowable".

Remark:

1. Above plate will be printed on the surface of the battery.
2. The date code "YYMMDD" represents the date of production.
3. By agreement between the cell manufacturer and the battery manufacturer, component cells used in the manufacture of a battery need not be marked.

Test item particulars.....	: --
Classification of installation and use.....	: --
Supply Connection.....	: DC lead wire
Recommend charging method declared by the manufacturer.....	: CC/CV
Discharge current (0,2 It A).....	: 100mA(Cell), 100mA(Battery)
Specified final voltage.....	: 3.0V(Cell), 3.0V(Battery)
Upper limit charging voltage per cell.....	: 4.2V
Maximum charging current.....	: 500mA(Cell), 500mA(Battery)
Charging temperature upper limit.....	: 45°C
Charging temperature lower limit.....	: 0°C
Polymer cell electrolyte type.....	: <input type="checkbox"/> gel polymer <input type="checkbox"/> solid polymer <input checked="" type="checkbox"/> N/A
Possible test case verdicts:	
- test case does not apply to the test object.....	: N/A
- test object does meet the requirement.....	: P (Pass)
- test object does not meet the requirement.....	: F (Fail)
Testing.....	
Date of receipt of test item.....	: 2023-07-05
Date (s) of performance of tests.....	: 2023-07-05 to 2023-07-12
General remarks:	
"(See Enclosure #)" refers to additional information appended to the report. "(See appended table)" refers to a table appended to the report.	
Throughout this report a <input type="checkbox"/> comma / <input checked="" type="checkbox"/> point is used as the decimal separator.	
Name and address of factory (ies).....	: Same as applicant

General product information and other remarks:

The product covered by this report is Polymer Li-ion Rechargeable Battery(model: 702040) consists of Polymer Li-ion Rechargeable Cell (model: 702040) in 1S1P which tested with appliance as per IEC 62133-2:2017 in the report.

The main features of the battery are shown as below (clause 7.1.1):

Model	Nominal capacity	Nominal voltage	Nominal Charge Current	Nominal Discharge Current	Maximum Charge Current	Maximum Discharge Current	Maximum Charge Voltage	Final Voltage
702040	500mAh	3.7V	100mA	100mA	500mA	500mA	4.2V	3.0V

The main features of the cell in the battery pack are shown as below (clause 7.1.1):

Model	Nominal capacity	Nominal voltage	Nominal Charge Current	Nominal Discharge Current	Maximum Charge Current	Maximum Discharge Current	Maximum Charge Voltage	Cut-off Voltage
702040	500mAh	3.7V	100mA	100mA	500mA	500mA	4.2V	3.0V

The main features of the cell are shown as below (clause 7.1.2):

Model	Upper limit charge voltage	Taper-off current	Lower charge temperature	Upper charge temperature
702040	4.2V	25mA	0°C	45°C

IEC 62133-2			
Clause	Requirement + Test	Result - Remark	Verdict
4	PARAMETER MEASUREMENT TOLERANCES		P
	Parameter measurement tolerances		P
5	GENERAL SAFETY CONSIDERATIONS		P
5.1	General		P
	Cells and batteries so designed and constructed that they are safe under conditions of both intended use and reasonably foreseeable misuse		P
5.2	Insulation and wiring		P
	The insulation resistance between the positive terminal and externally exposed metal surfaces of the battery (excluding electrical contact surfaces) is not less than 5 MΩ	No metal case exists.	N/A
	Insulation resistance (MΩ)..... :		—
	Internal wiring and insulation are sufficient to withstand maximum anticipated current, voltage and temperature requirements		P
	Orientation of wiring maintains adequate clearance and creepage distances between conductors		P
	Mechanical integrity of internal connections accommodates reasonably foreseeable misuse		P
5.3	Venting		P
	Battery cases and cells incorporate a pressure relief mechanism or are constructed so that they relieve excessive internal pressure at a value and rate that will preclude rupture, explosion and self-ignition	Venting mechanism exists on the narrow side of pouch cell.	P
	Encapsulation used to support cells within an outer casing does not cause the battery to overheat during normal operation nor inhibit pressure relief		N/A
5.4	Temperature, voltage and current management		P
	Batteries are designed such that abnormal temperature rise conditions are prevented		P
	Batteries are designed to be within temperature, voltage and current limits specified by the cell manufacturer	Cell specification and battery specification have been provided. The design of the battery refers to the parameters of the cell	P
	Batteries are provided with specifications and charging instructions for equipment manufacturers so that specified chargers are designed to maintain charging within the temperature, voltage and current limits specified	Battery specifications have been provided.	P
5.5	Terminal contacts		P

IEC 62133-2			
Clause	Requirement + Test	Result - Remark	Verdict
	The size and shape of the terminal contacts ensure that they can carry the maximum anticipated current		P
	External terminal contact surfaces are formed from conductive materials with good mechanical strength and corrosion resistance		P
	Terminal contacts are arranged to minimize the risk of short-circuit		P
5.6	Assembly of cells into batteries		P
5.6.1	General		P
	Each battery have an independent control and protection for current, voltage, temperature and any other parameter required for safety and to maintain the cells within their operating region		P
	This protection may be provided external to the battery such as within the charger or the end devices		N/A
	If protection is external to the battery, the manufacturer of the battery provide this safety relevant information to the external device manufacturer for implementation		N/A
	If there is more than one battery housed in a single battery case, each battery have protective circuitry that can maintain the cells within their operating regions		N/A
	Manufacturers of cells specify current, voltage and temperature limits so that the battery manufacturer/designer may ensure proper design and assembly	Current, voltage and temperature limits specified by cell manufacturer.	P
	Batteries that are designed for the selective discharge of a portion of their series connected cells incorporate circuitry to prevent operation of cells outside the limits specified by the cell manufacturer	Battery without selective discharge function.	N/A
	Protective circuit components added as appropriate and consideration given to the end-device application		P
	The manufacturer of the battery provide a safety analysis of the battery safety circuitry with a test report including a fault analysis of the protection circuit under both charging and discharging conditions confirming the compliance		N/A
5.6.2	Design recommendation		P
	For the battery consisting of a single cell or a single cellblock, it is recommended that the charging voltage of the cell does not exceed the upper limit of the charging voltage specified in Table 2	Cell upper limit of the charging voltage: 4.2V	P

IEC 62133-2			
Clause	Requirement + Test	Result - Remark	Verdict
	For the battery consisting of series-connected plural single cells or series-connected plural cellblocks, it is recommended that the voltages of any one of the single cells or single cellblocks does not exceed the upper limit of the charging voltage, specified in Table 2, by monitoring the voltage of every single cell or the single cellblocks		N/A
	For the battery consisting of series-connected plural single cells or series-connected plural cellblocks, it is recommended that charging is stopped when the upper limit of the charging voltage is exceeded for any one of the single cells or single cellblocks by measuring the voltage of every single cell or the single cellblocks		N/A
	For batteries consisting of series-connected cells or cell blocks, nominal charge voltage not be counted as an overcharge protection		N/A
	For batteries consisting of series-connected cells or cell blocks, cells have closely matched capacities, be of the same design, be of the same chemistry and be from the same manufacturer		N/A
	It is recommended that the cells and cell blocks not discharged beyond the cell manufacturer's specified final voltage		P
	For batteries consisting of series-connected cells or cell blocks, cell balancing circuitry incorporated into the battery management system		N/A
5.6.3	Mechanical protection for cells and components of batteries	Shall be evaluate in end product.	N/A
	Mechanical protection for cells, cell connections and control circuits within the battery provided to prevent damage as a result of intended use and reasonably foreseeable misuse		N/A
	The mechanical protection can be provided by the battery case or it can be provided by the end product enclosure for those batteries intended for building into an end product		N/A
	The battery case and compartments housing cells designed to accommodate cell dimensional tolerances during charging and discharging as recommended by the cell manufacturer		N/A
	For batteries intended for building into a portable end product, testing with the battery installed within the end product considered when conducting mechanical tests		N/A
5.7	Quality plan		N/A

IEC 62133-2			
Clause	Requirement + Test	Result - Remark	Verdict
	The manufacturer prepares and implements a quality plan that defines procedures for the inspection of materials, components, cells and batteries and which covers the whole process of producing each type of cell or battery		N/A
5.8	Battery safety components		N/A
	According annex F		N/A
6	TYPE TEST AND SAMPLE SIZE		P
	Tests are made with the number of cells or batteries specified in Table 1 using cells or batteries that are not more than six months old		P
	Coin cells with resistance $\leq 3 \Omega$ (measured according annex D) are tested according table 1	Not coin cell.	N/A
	Unless otherwise specified, tests are carried out in an ambient temperature of $20 \text{ }^\circ\text{C} \pm 5 \text{ }^\circ\text{C}$		P
	The safety analysis of 5.6.1 identify those components of the protection circuit that are critical for short-circuit, overcharge and overdischarge protection		N/A
	When conducting the short-circuit test, consideration given to the simulation of any single fault condition that is likely to occur in the protecting circuit that would affect the short-circuit test		P
7	SPECIFIC REQUIREMENTS AND TESTS		P
7.1	Charging procedure for test purposes		P
7.1.1	First procedure		P
	This charging procedure applies to subclauses other than those specified in 7.1.2		P
	Unless otherwise stated in this document, the charging procedure for test purposes is carried out in an ambient temperature of $20 \text{ }^\circ\text{C} \pm 5 \text{ }^\circ\text{C}$, using the method declared by the manufacturer		P
	Prior to charging, the battery have been discharged at $20 \text{ }^\circ\text{C} \pm 5 \text{ }^\circ\text{C}$ at a constant current of 0,2 It A down to a specified final voltage		P
7.1.2	Second procedure		P
	This charging procedure applies only to 7.3.1, 7.3.4, 7.3.5, and 7.3.9		P

IEC 62133-2			
Clause	Requirement + Test	Result - Remark	Verdict
	After stabilization for 1 h and 4 h, respectively, at ambient temperature of highest test temperature and lowest test temperature, as specified in Table 2, cells are charged by using the upper limit charging voltage and maximum charging current, until the charging current is reduced to 0,05 It A, using a constant voltage charging method	Highest test temperature: 45°C Lowest test temperature: 0°C	P
7.2	Intended use		P
7.2.1	Continuous charging at constant voltage (cells)	Tested complied.	P
	Fully charged cells are subjected for 7 days to a charge using the charging method for current and standard voltage specified by the cell manufacturer		P
	Results: No fire. No explosion. No leakage..... :	(See appended table 7.2.1)	P
7.2.2	Case stress at high ambient temperature (battery)	Tested as client requested.	P
	Oven temperature (°C)..... :	70	—
	Results: No physical distortion of the battery case resulting in exposure of internal protective components and cells		P
7.3	Reasonably foreseeable misuse		P
7.3.1	External short-circuit (cell)	Tested complied.	P
	The cells were tested until one of the following occurred:		P
	- 24 hours elapsed; or		N/A
	- The case temperature declined by 20 % of the maximum temperature rise		P
	Results: No fire. No explosion..... :	(See appended table 7.3.1)	P
7.3.2	External short-circuit (battery)	Test complied.	P
	The batteries were tested until one of the following occurred:		P
	- 24 hours elapsed; or		N/A
	- The case temperature declined by 20 % of the maximum temperature rise		N/A
	In case of rapid decline in short circuit current, the battery pack remained on test for an additional one hour after the current reached a low end steady state condition		P
	A single fault in the discharge protection circuit conducted on one to four (depending upon the protection circuit) of the five samples before conducting the short-circuit test	Single fault conducted on four samples.	P

IEC 62133-2			
Clause	Requirement + Test	Result - Remark	Verdict
	A single fault applies to protective component parts such as MOSFET, fuse, thermostat or positive temperature coefficient (PTC) thermistor	Single fault applies on MOSFET U2	P
	Results: No fire. No explosion..... :	(See appended table 7.3.2)	P
7.3.3	Free fall	Tested complied.	P
	Results: No fire. No explosion		P
7.3.4	Thermal abuse (cells)	Tested complied.	P
	Oven temperature (°C)..... :	130	—
	Results: No fire. No explosion		P
7.3.5	Crush (cells)	Tested complied.	P
	The crushing force was released upon:		P
	- The maximum force of 13 kN ± 0,78 kN has been applied; or		P
	- An abrupt voltage drop of one-third of the original voltage has been obtained		N/A
	Results: No fire. No explosion..... :	(See appended table 7.3.5)	P
7.3.6	Over-charging of battery	Tested complied.	P
	The supply voltage which is:		P
	- 1,4 times the upper limit charging voltage presented in Table A.1 (but not to exceed 6,0 V) for single cell/cell block batteries or	5.88V applied.	P
	- 1,2 times the upper limit charging voltage presented in Table A.1 per cell for series connected multi-cell batteries, and		N/A
	- Sufficient to maintain a current of 2,0 It A throughout the duration of the test or until the supply voltage is reached		P
	Test was continued until the temperature of the outer casing:		P
	- Reached steady state conditions (less than 10 °C change in 30-minute period); or		P
	- Returned to ambient		N/A
	Results: No fire. No explosion..... :	(See appended table 7.3.6)	P
7.3.7	Forced discharge (cells)	Tested complied.	P
	If the discharge voltage reaches the negative value of upper limit charging voltage within the testing duration, the voltage is maintained at the negative value of the upper limit charging voltage by reducing the current for the remainder of the testing duration		N/A

IEC 62133-2			
Clause	Requirement + Test	Result - Remark	Verdict
	If the discharge voltage does not reach the negative value of upper limit charging voltage within the testing duration, the test is terminated at the end of the testing duration		P
	Results: No fire. No explosion..... :	(See appended table 7.3.7)	P
7.3.8	Mechanical tests (batteries)	Tested complied.	P
7.3.8.1	Vibration		P
	Results: No fire, no explosion, no rupture, no leakage or venting..... :	(See appended table 7.3.8.1)	P
7.3.8.2	Mechanical shock	Tested complied.	P
	Results: No leakage, no venting, no rupture, no explosion and no fire..... :	(See appended table 7.3.8.2)	P
7.3.9	Design evaluation – Forced internal short-circuit (cells)	Tested complied.	P
	The cells complied with national requirement for..... :	France, Japan, Republic of Korea, Switzerland	—
	The pressing was stopped upon:		P
	- A voltage drop of 50 mV has been detected; or		N/A
	- The pressing force of 800 N (cylindrical cells) or 400 N (prismatic cells) has been reached	400N for prismatic cells	P
	Results: No fire..... :	(See appended table 7.3.9)	P
8	INFORMATION FOR SAFETY		P
8.1	General		P
	Manufacturers of secondary cells ensure that information is provided about current, voltage and temperature limits of their products	Information for safety mentioned in manufacturer's specifications	P
	Manufacturers of batteries ensure that equipment manufacturers and, in the case of direct sales, end-users are provided with information to minimize and mitigate hazards	Information for safety mentioned in manufacturer's specifications	P
	Systems analyses performed by device manufacturers to ensure that a particular battery design prevents hazards from occurring during use of a product	Considered in end product.	N/A
	As appropriate, any information relating to hazard avoidance resulting from a system analysis provided to the end user	Considered in end product.	N/A
8.2	Small cell and battery safety information		P
	The following warning language is to be provided with the information packaged with the small cells and batteries or equipment using them:		P

IEC 62133-2			
Clause	Requirement + Test	Result - Remark	Verdict
	- Keep small cells and batteries which are considered swallowable out of the reach of children		P
	- Swallowing may lead to burns, perforation of soft tissue, and death. Severe burns can occur within 2 h of ingestion		P
	- In case of ingestion of a cell or battery, seek medical assistance promptly		P
9	MARKING		P
9.1	Cell marking		P
	Cells marked as specified in IEC 61960, except coin cells		N/A
	Coin cells whose external surface area is too small to accommodate the markings on the cells show the designation and polarity		N/A
	By agreement between the cell manufacturer and the battery and/or end product manufacturer, component cells used in the manufacture of a battery need not be marked		P
9.2	Battery marking		P
	Batteries marked as specified in IEC 61960, except for coin batteries	IEC Designation: 1ICP7/20/40	P
	Coin batteries whose external surface area is too small to accommodate the markings on the batteries show the designation and polarity. Batteries also marked with an appropriate caution statement	Not coin battery.	N/A
	Terminals have clear polarity marking on the external surface of the battery		P
	Batteries with keyed external connectors designed for connection to specific end products need not be marked with polarity markings if the design of the external connector prevents reverse polarity connections		N/A
9.3	Caution for ingestion of small cells and batteries		P
	Coin cells and batteries identified as small batteries according to 8.2 include a caution statement regarding the hazards of ingestion in accordance with 8.2	Not coin cells and batteries.	N/A
	When small cells and batteries are intended for direct sale in consumer-replaceable applications, caution for ingestion given on the immediate package		P
9.4	Other information		P

IEC 62133-2			
Clause	Requirement + Test	Result - Remark	Verdict
	Storage and disposal instructions		P
	Recommended charging instructions		P

10	PACKAGING AND TRANSPORT		P
	Packaging for coin cells not small enough to fit within the limits of the ingestion gauge of Figure 3	Not coin cells	N/A
	The materials and packaging design are chosen so as to prevent the development of unintentional electrical conduction, corrosion of the terminals and ingress of environmental contaminants		P

ANNEX A	CHARGING AND DISCHARGING RANGE OF SECONDARY LITHIUM ION CELLS FOR SAFE USE		P
A.1	General		P
A.2	Safety of lithium ion secondary battery		P
A.3	Consideration on charging voltage		P
A.3.1	General		P
A.3.2	Upper limit charging voltage	Upper limit charging voltage of cell is 4.2V.	P
A.3.2.1	General		P
A.3.2.2	Explanation of safety viewpoint		N/A
A.3.2.3	Safety requirements, when different upper limit charging voltage is applied		N/A
A.4	Consideration of temperature and charging current		P
A.4.1	General		P
A.4.2	Recommended temperature range	Charging temperature range declared by client is 0-45°C.	P
A.4.2.1	General		P
A.4.2.2	Safety consideration when a different recommended temperature range is applied		P
A.4.3	High temperature range		N/A
A.4.3.1	General		N/A
A.4.3.2	Explanation of safety viewpoint		N/A
A.4.3.3	Safety considerations when specifying charging conditions in the high temperature range		N/A
A.4.3.4	Safety considerations when specifying a new upper limit in the high temperature range		N/A
A.4.4	Low temperature range		N/A

IEC 62133-2			
Clause	Requirement + Test	Result - Remark	Verdict
A.4.4.1	General		N/A
A.4.4.2	Explanation of safety viewpoint		N/A
A.4.4.3	Safety considerations, when specifying charging conditions in the low temperature range		N/A
A.4.4.4	Safety considerations when specifying a new lower limit in the low temperature range		N/A
A.4.5	Scope of the application of charging current		P
A.4.6	Consideration of discharge		P
A.4.6.1	General		P
A.4.6.2	Final discharge voltage and explanation of safety viewpoint		P
A.4.6.3	Discharge current and temperature range		P
A.4.6.4	Scope of application of the discharging current		P
A.5	Sample preparation		P
A.5.1	General		P
A.5.2	Insertion procedure for nickel particle to generate internal short		P
A.5.3	Disassembly of charged cell		P
A.5.4	Shape of nickel particle		P
A.5.5	Insertion of nickel particle in cylindrical cell		N/A
A.5.5.1	Insertion of nickel particle in winding core		N/A
A.5.5.2	Marking the position of the nickel particle on both ends of the winding core of the separator		N/A
A.5.6	Insertion of nickel particle in prismatic cell		P
A.6	Experimental procedure of the forced internal short-circuit test		P
A.6.1	Material and tools for preparation of nickel particle		P
A.6.2	Example of a nickel particle preparation procedure		P
A.6.3	Positioning (or placement) of a nickel particle		P
A.6.4	Damaged separator precaution		P
A.6.5	Caution for rewinding separator and electrode		P
A.6.6	Insulation film for preventing short-circuit		P
A.6.7	Caution when disassembling a cell		P
A.6.8	Protective equipment for safety		P
A.6.9	Caution in the case of fire during disassembling		P
A.6.10	Caution for the disassembling process and pressing the electrode core		P

IEC 62133-2			
Clause	Requirement + Test	Result - Remark	Verdict
A.6.11	Recommended specifications for the pressing device		P
ANNEX B	RECOMMENDATIONS TO EQUIPMENT MANUFACTURERS AND BATTERY ASSEMBLERS		P
ANNEX C	RECOMMENDATIONS TO THE END-USERS		P
ANNEX D	MEASUREMENT OF THE INTERNAL AC RESISTANCE FOR COIN CELLS		N/A
D.1	General		N/A
D.2	Method		N/A
	A sample size of three coin cells is required for this measurement.....:	(See appended table D.2)	N/A
	Coin cells with an internal resistance of less than or equal to 3 Ω are subjected to the testing according to Clause 6 and Table 1		N/A
	Coin cells with an internal resistance greater than 3 Ω require no further testing		N/A
ANNEX E	PACKAGING AND TRANSPORT		N/A
ANNEX F	COMPONENT STANDARDS REFERENCES		N/A

IEC 62133-2			
Clause	Requirement + Test	Result - Remark	Verdict

TABLE: Critical components information					
Object / part No.	Manufacturer / trademark	Type / model	Technical data	Standard	Mark(s) of conformity ¹⁾
Cell		702040	3.7V, 500mAh, 1.85Wh	IEC 62133-2:2017	Tested with appliance
Supplementary information: ¹⁾ Provided evidence ensures the agreed level of compliance. See OD-CB2039. Client did not provided relevant information.					

IEC 62133-2			
Clause	Requirement + Test	Result - Remark	Verdict

7.2.1	TABLE: Continuous charging at constant voltage (cells)				P
Sample no.	Recommended charging voltage Vc (Vdc)	Recommended charging current I _{rec} (A)	OCV before test (Vdc)	Results	
C01#	4.2	0.1	4.191	P	
C02#	4.2	0.1	4.190	P	
C03#	4.2	0.1	4.188	P	
C04#	4.2	0.1	4.192	P	
C05#	4.2	0.1	4.189	P	
Supplementary information:					
- No fire or explosion					
- No leakage					
- The ambient temperature is 22.9°C					

7.3.1	TABLE: External short-circuit (cell)					P
Sample no.	Ambient T (°C)	OCV before test (Vdc)	Resistance of circuit (mΩ)	Maximum case temperature rise ΔT (K)	Results	
Samples charged at charging temperature upper limit¹⁾						
C06#	54.2	4.179	73	64.0	P	
C07#	54.2	4.179	74	62.1	P	
C08#	54.2	4.170	82	59.3	P	
C09#	54.2	4.179	79	63.6	P	
C10#	54.2	4.173	86	61.1	P	
Samples charged at charging temperature lower limit²⁾						
C11#	54.5	4.097	77	60.5	P	
C12#	54.5	4.102	72	59.5	P	
C13#	54.5	4.102	80	60.9	P	
C14#	54.5	4.109	78	62.8	P	
C15#	54.5	4.099	73	58.7	P	
Supplementary information:						
- No fire or explosion						
1) Cells charged at 45°C						
2) Cells charged at 0°C						

IEC 62133-2						
Clause	Requirement + Test				Result - Remark	Verdict
7.3.2	TABLE: External short-circuit (battery)					P
Sample no.	Ambient T (°C)	OCV before test (Vdc)	Resistance of circuit (mΩ)	Maximum case temperature rise ΔT (K)	Component single fault condition	Results
B04#	22.6	4.180	83	91.8	SC MOSFET(U2)	P
B05#	22.6	4.182	79	91.5	SC MOSFET(U2)	P
B06#	22.6	4.191	76	90.0	SC MOSFET(U2)	P
B07#	22.6	4.180	83	91.8	SC MOSFET(U2)	P
B08#	22.6	4.191	86	1.5	Normal	P
Supplementary information:						
- No fire or explosion						
- SC means short-circuit						

7.3.5	TABLE: Crush (cells)				P
Sample no.	OCV before test (Vdc)	OCV at removal of crushing force (Vdc)	Maximum force applied to the cell during crush (kN)	Results	
Samples charged at charging temperature upper limit¹⁾					
C29#	4.173	4.172	12.98	P	
C30#	4.191	4.189	12.99	P	
C31#	4.190	4.187	13.03	P	
C32#	4.168	4.166	12.94	P	
C33#	4.189	4.186	12.92	P	
Samples charged at charging temperature lower limit²⁾					
C34#	4.099	4.098	12.91	P	
C35#	4.110	4.110	13.01	P	
C36#	4.111	4.110	12.99	P	
C37#	4.114	4.111	12.93	P	
C38#	4.118	4.115	12.89	P	
Supplementary information:					
- No fire or explosion					
1) Cells charged at 45°C					
2) Cells charged at 0°C					
- The ambient temperature is 23.5°C					

IEC 62133-2			
Clause	Requirement + Test	Result - Remark	Verdict

7.3.6	TABLE: Over-charging of battery			P
Constant charging current (A).....:		1		—
Supply voltage (Vdc).....:		5.88		—
Sample no.	OCV before charging (Vdc)	Total charging time (minute)	Maximum outer case temperature (°C)	Results
B12#	3.312	120	36.0	P
B13#	3.289	120	35.4	P
B14#	3.311	120	35.2	P
B15#	3.295	120	37.6	P
B16#	3.310	120	35.0	P
Supplementary information:				
- No fire or explosion				
- The ambient temperature is 23.5°C				

7.3.7	TABLE: Forced discharge (cells)			P
Sample no.	OCV before application of reverse charge (Vdc)	Measured reverse charge I_t (A)	Lower limit discharge voltage (Vdc)	Results
C39#	3.324	0.5	3.0	P
C40#	3.322	0.5	3.0	P
C41#	3.327	0.5	3.0	P
C42#	3.319	0.5	3.0	P
C43#	3.326	0.5	3.0	P
Supplementary information:				
- No fire or explosion				
- The ambient temperature is 23.9°C				

7.3.8.1	TABLE: Vibration				P
Sample no.	OCV before test (Vdc)	OCV after test (Vdc)	Mass before test (g)	Mass after test (g)	Results
B17#	4.191	4.189	10.109	10.106	P
B18#	4.180	4.180	10.189	10.187	P
B19#	4.190	4.189	10.129	10.128	P
Supplementary information:					
- No fire or explosion					
- No rupture					
- No leakage					
- No venting					
- The ambient temperature is 24.5°C					

IEC 62133-2			
Clause	Requirement + Test	Result - Remark	Verdict

7.3.8.2	TABLE: Mechanical shock					P
Sample no.	OCV before test (Vdc)	OCV after test (Vdc)	Mass before test (g)	Mass after test (g)	Results	
B20#	4.182	4.181	10.117	10.115	P	
B21#	4.178	4.178	10.044	10.044	P	
B22#	4.180	4.179	10.008	10.007	P	

Supplementary information:

- No fire or explosion
- No rupture
- No leakage
- No venting
- The ambient temperature is 23.9°C

7.3.9	TABLE: Forced internal short circuit (cells)					P
Sample no.	Chamber ambient T (°C)	OCV before test (Vdc)	Particle location ¹⁾	Maximum applied pressure (N)	Results	
Samples charged at charging temperature upper limit²⁾						
C44#	45	4.172	1	400	P	
C45#	45	4.189	1	400	P	
C46#	45	4.166	1	400	P	
C47#	45	4.189	1	400	P	
C48#	45	4.184	1	400	P	
Samples charged at charging temperature lower limit³⁾						
C49#	0	4.106	1	400	P	
C50#	0	4.108	1	400	P	
C51#	0	4.107	1	400	P	
C52#	0	4.114	1	400	P	
C53#	0	4.101	1	400	P	

Supplementary information:

¹⁾ Identify one of the following:
1: Nickel particle inserted between positive and negative (active material) coated area.
2: Nickel particle inserted between positive aluminium foil and negative active material coated area.

²⁾ Cells charged at 45°C
³⁾ Cells charged at 0°C

IEC 62133-2			
Clause	Requirement + Test	Result - Remark	Verdict

D.2	TABLE: Internal AC resistance for coin cells			N/A
Sample no.	Ambient T (°C)	Store time (h)	Resistance Rac (Ω)	Results ¹⁾

Supplementary information:

¹⁾ Coin cells with internal resistance less than or equal to 3 Ω, see test result on corresponding tables

Circuit diagram

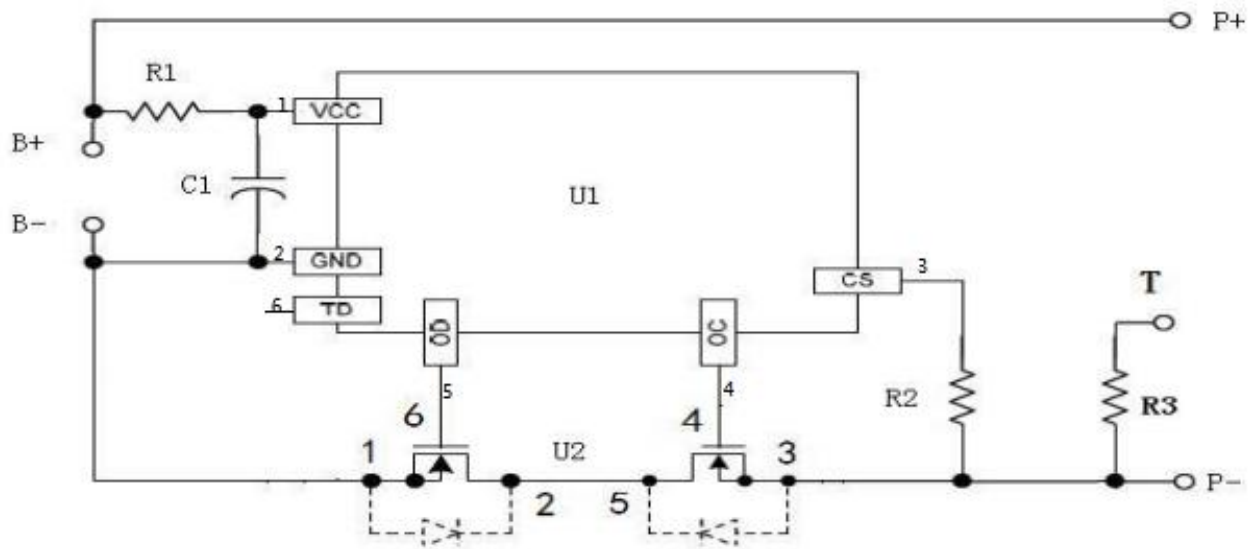

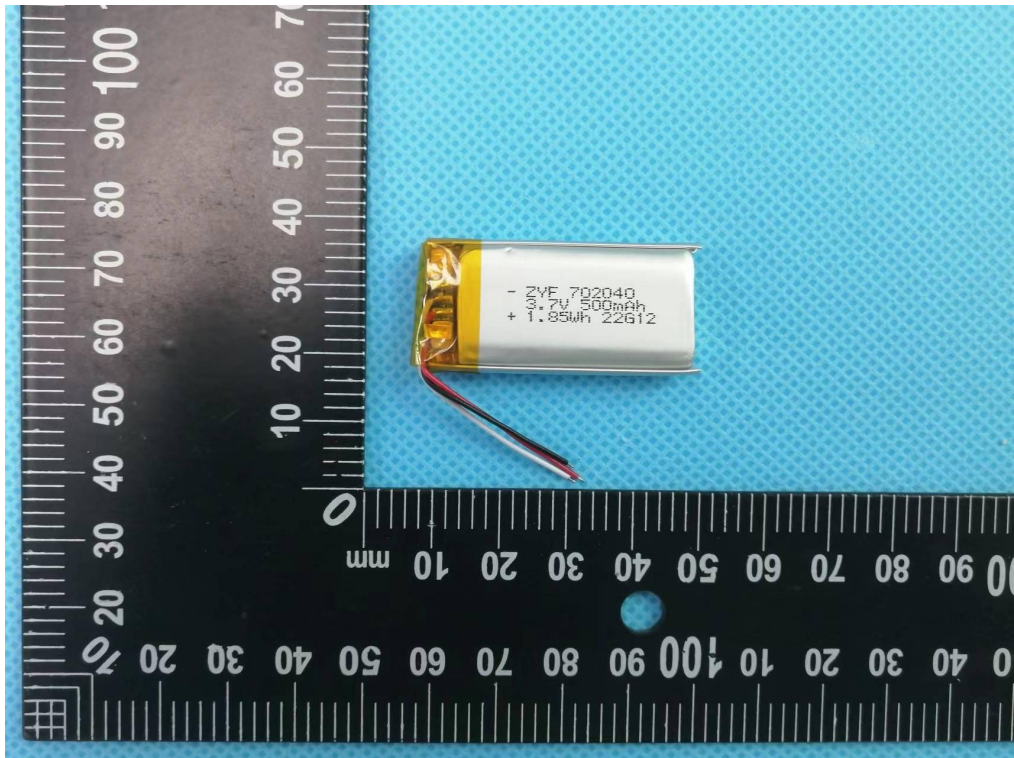

Front view of battery

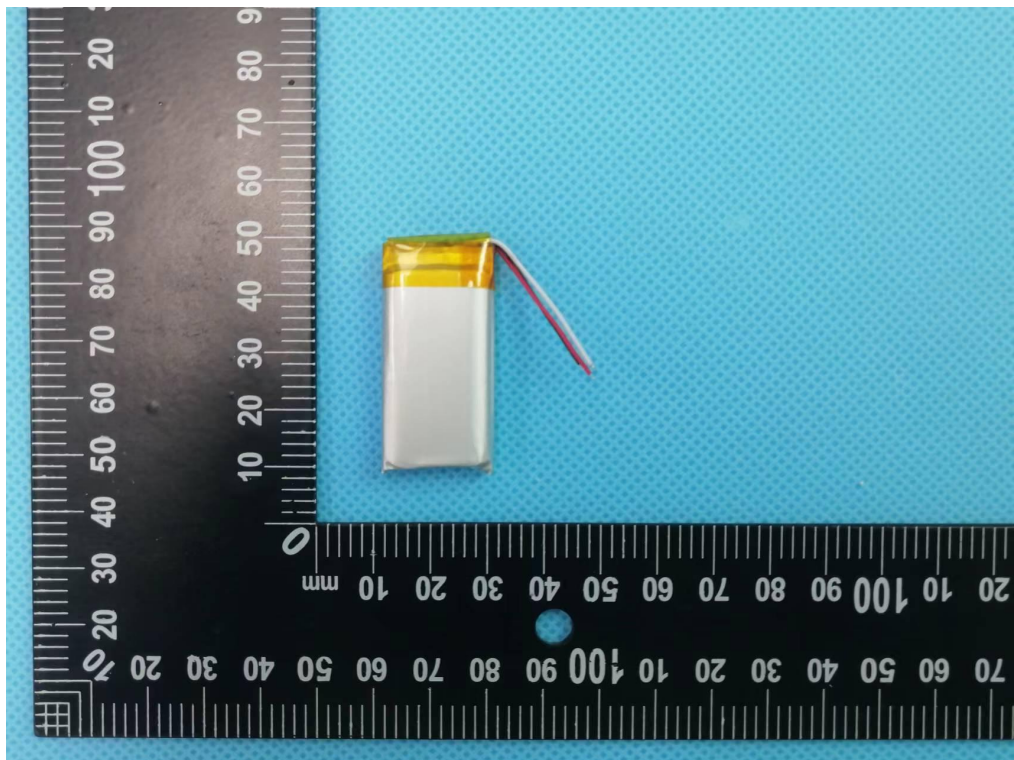

Back view of battery

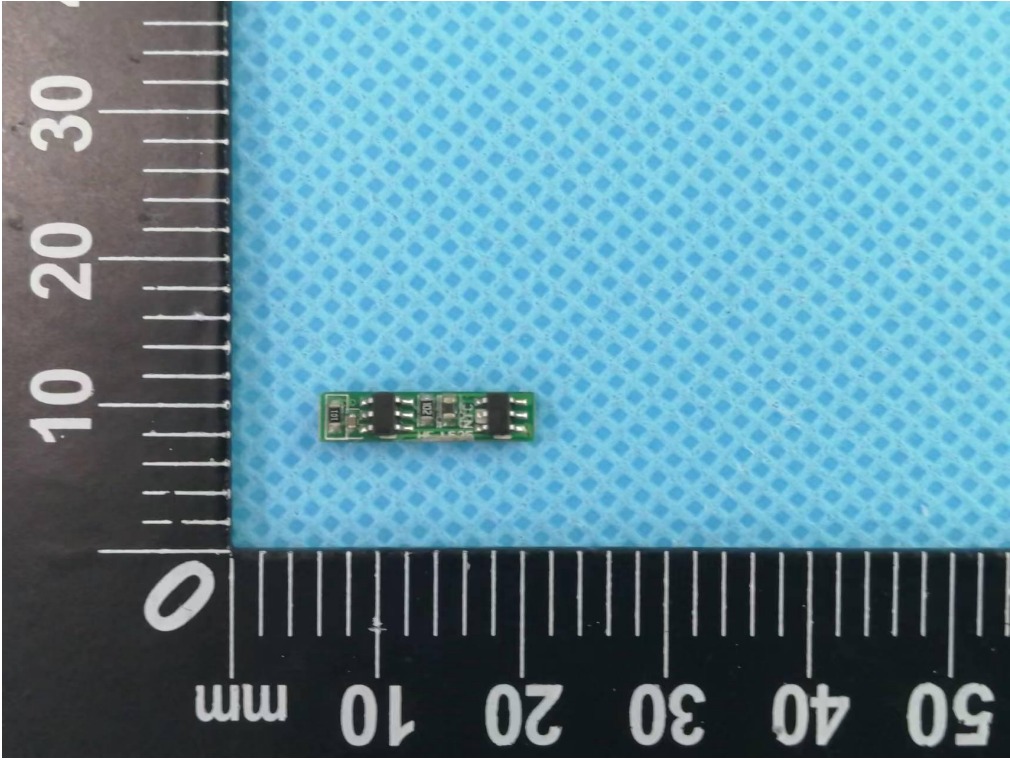

Front view of PCM

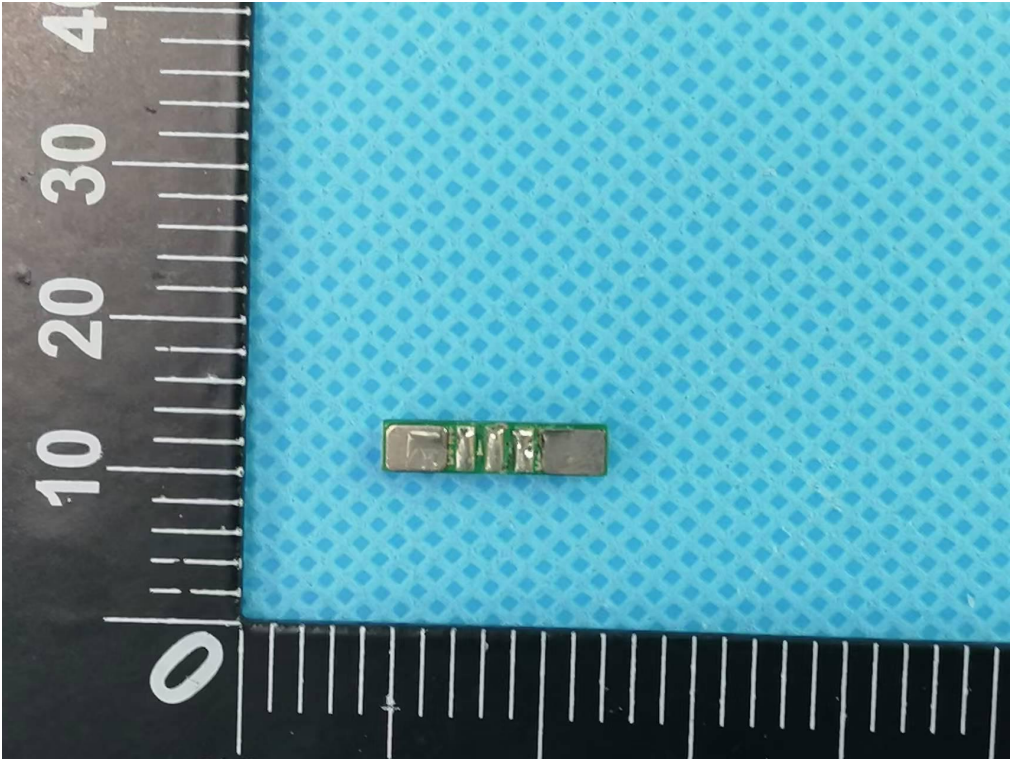

Back view of PCM

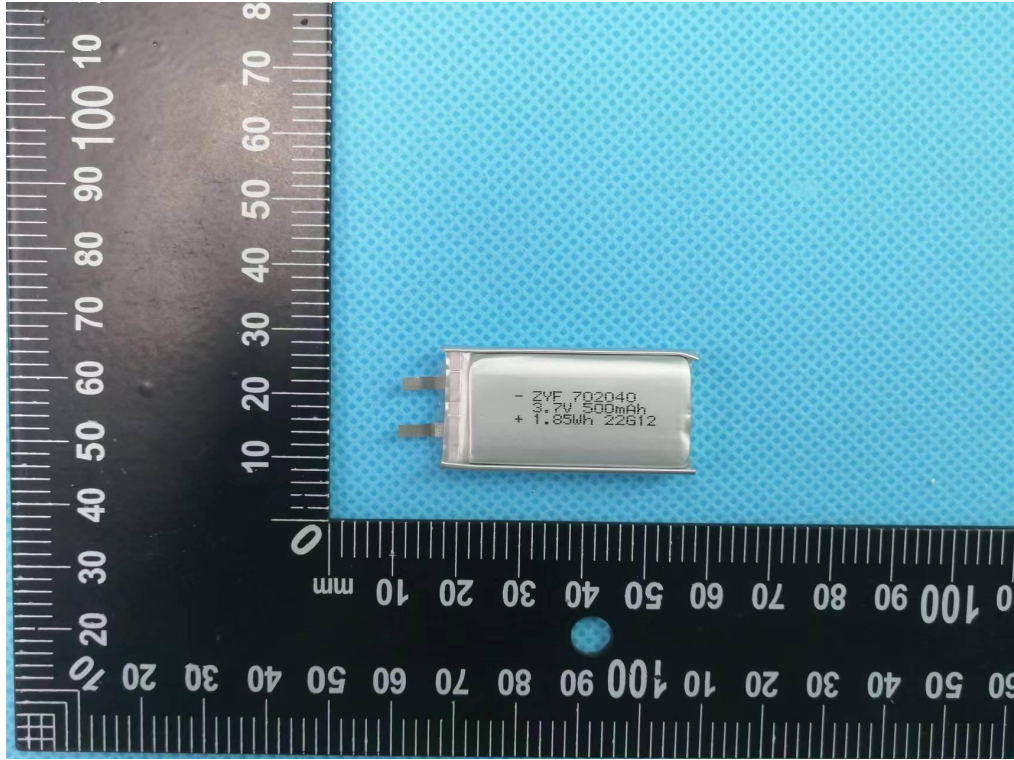

View of cell-1

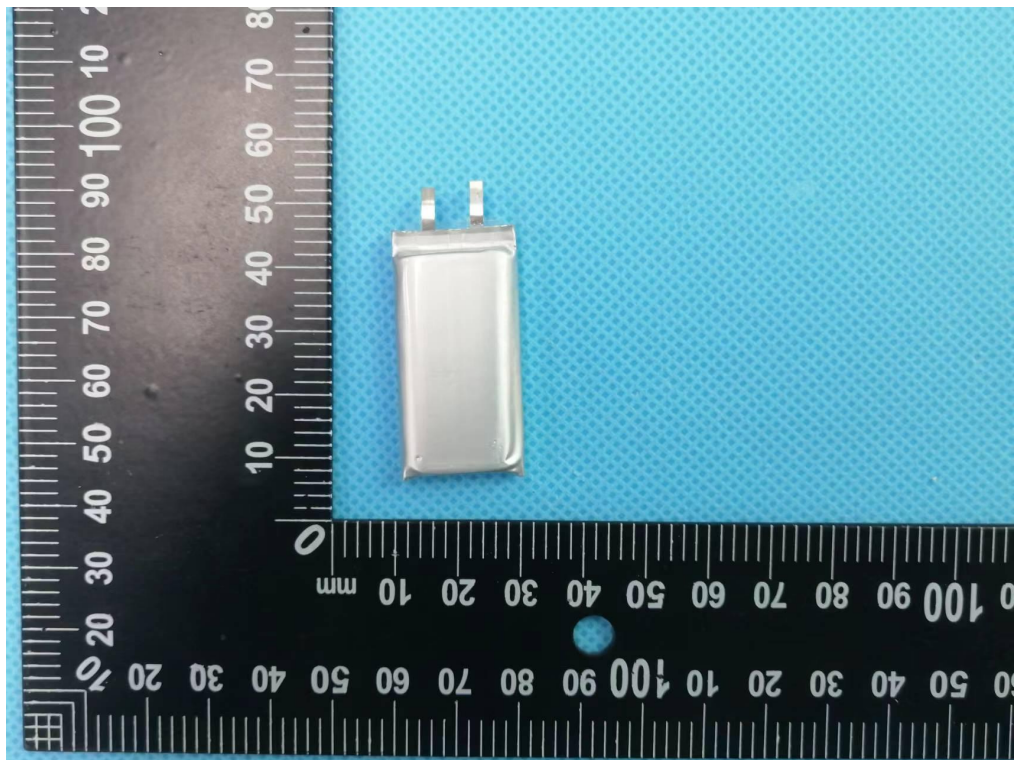

View of cell-2