



# RF TEST REPORT

Report No: FCS202312148W01

Issued for

Applicant:	Mid Ocean Brands B.V.
Address:	7/F, Kings Tower, 111 King Lam Street, Cheung Sha Wan, Kowloon, Hong Kong.
Product Name:	Wireless speaker
Brand Name:	N/A
Model Name:	MO2210
Series Model:	N/A
Test Standards:	ETSI EN 300 328 V2.2.2 (2019-07)
Issued By: Dongguan Funas Testing Technology Co., Ltd. Add: Room 105, 1/F.. Baohao Technology Building 1, No.15, Gongye West Road.Songshan Lake Hi-Tech Industrial Area, Dongguan, Guangdong, China Tel: 769-27280901 Fax:769-27280901 <a href="http://www.fcs-lab.com">http://www.fcs-lab.com</a>	



### TEST REPORT CERTIFICATION

**Applicant's name**.....: Mid Ocean Brands B.V.  
 Address.....: 7/F, Kings Tower, 111 King Lam Street, Cheung Sha Wan, Kowloon, Hong Kong.  
**Manufacture's Name**.....: Mid Ocean Brands B.V.  
 Address.....: 7/F, Kings Tower, 111 King Lam Street, Cheung Sha Wan, Kowloon, Hong Kong.

#### Product description

Product Name.....: Wireless speaker  
 Brand Name .....: N/A  
 Model Name.....: MO2210  
 Series Model.....: N/A

**Test Standards**.....: ETSI EN 300 328 V2.2.2 (2019-07)

This device described above has been tested by FCS, the test results show that the equipment under test (EUT) is in compliance with the 2014/53/EU RE Directive Art.3.2 requirements. And it is applicable only to the tested sample identified in the report.

This report shall not be reproduced except in full, without the written approval of FCS, this document only be altered or revised by FCS, personal only and shall be noted in the revision of the document

**Date of Test**.....:   
 Date (s) of performance of tests.....: Dec 10, 2023 ~ Dec 15, 2023  
 Date of Issue.....: Dec 15, 2023  
 Test Result.....: **Pass**

Tested by : Scott Shen  
 (Scott Shen)  
 Reviewed by : Scott Shen  
 (Scott Shen)  
 Approved by : Jack Wang  
 (Jack Wang)





Table of Contents

- 1. SUMMARY OF TEST RESULTS ..... 6**
  - 1.1 TEST FACTORY ..... 7
  - 1.2 MEASUREMENT UNCERTAINTY ..... 7
- 2. GENERAL INFORMATION ..... 8**
  - 2.1 GENERAL DESCRIPTION OF THE EUT ..... 8
  - 2.2 ENVIRONMENTAL CONDITIONS FOR TESTING ..... 13
  - 2.3 TEST MODE ..... 13
  - 2.4 DESCRIPTION OF NECESSARY ACCESSORIES AND SUPPORT UNITS ..... 14
  - 2.5 EQUIPMENTS LIST ..... 15
- 3. RF OUTPUT POWER ..... 16**
  - 3.1 LIMIT ..... 16
  - 3.2 TEST PROCEDURES ..... 16
  - 3.3 TEST SETUP ..... 16
  - 3.4 TEST RESULT ..... 17
- 4. ACCUMULATED TRANSMIT TIME, FREQUENCY OCCUPATION ..... 20**
  - & HOPPING SEQUENCE ..... 20**
    - 4.1 LIMIT ..... 20
    - 4.2 TEST PROCEDURE ..... 21
    - 4.3 TEST SETUP ..... 21
    - 4.4 TEST RESULT ..... 22
- 5. HOPPING FREQUENCY SEPARATION ..... 30**
  - 5.1 LIMIT ..... 30
  - 5.2 TEST PROCEDURE ..... 30
  - 5.3 TEST SETUP ..... 30
  - 5.4 TEST RESULT ..... 31
- 6. OCCUPIED CHANNEL BANDWIDT ..... 33**
  - 6.1 LIMIT ..... 33
  - 6.2 TEST PROCEDURES ..... 33
  - 6.3 TEST SETUP ..... 33
  - 6.4 TEST RESULT ..... 34
- 7. TRANSMITTER UNWANTED EMISSIONS INTHE OOB DOMAIN ..... 36**
  - 7.1 LIMIT ..... 36
  - 7.2 TEST PROCEDURES ..... 36
  - 7.3 TEST SETUP ..... 36
  - 7.4 TEST RESULT ..... 37
- 8. SPURIOUS EMISSIONS TRANSMITTER ..... 39**



8.1 LIMIT .....39

8.2 TEST PROCEDURES .....39

8.3 TEST SETUP .....40

8.4 EUT OPERATION DURING TEST .....41

8.5 TEST RESULT .....42

**9. SPURIOUS EMISSIONS – RECEIVER .....44**

9.1 LIMIT .....44

9.2 TEST PROCEDURES .....44

9.3 EUT OPERATION DURING TEST .....45

9.4 TEST SETUP .....45

9.5 TEST RESULT .....46

**10. RECEIVER BLOCKING .....47**

10.1 LIMIT .....47

10.2 TEST PROCEDURES .....48

10.3 TEST SETUP .....49

10.4 TEST RESULT .....50

**11. ADAPTIVE (CHANNEL ACCESS MECHANISM) .....52**

11.1 LIMIT .....52

11.2 TEST PROCEDURES .....52

11.3 TEST SETUP .....53

11.4 TEST RESULTS .....53





### Revision History

Rev.	Issue Date	Report No.	Effect Page	Contents
00	Dec 15. 2023	FCS202312148W01	N/A	Initial Issue

### 1. SUMMARY OF TEST RESULTS

Test procedures according to the technical standards:

ETSI EN 300 328 V2.2.2			
Test Item	Limit	Frequency Range (MHz)	Applicable (Yes/No)
<b>TRANSMITTER PARAMETERS</b>			
RF output power	Clause 4.3.1.2.3	2400-2483.5	Y
Duty Cycle, Tx-sequence, Tx-gap	Clause 4.3.1.3.3		N
Accumulated Transmit time, Frequency Occupation & Hopping Sequence	Clause 4.3.1.4.3		Y
Hopping Frequency Separation	Clause 4.3.1.5.3		Y
Medium Utilisation	Clause 4.3.1.6.3		N
Adaptivity(Adaptive Frequency Hopping)	Clause 4.3.1.7		N
Occupied Channel Bandwidth	Clause 4.3.1.8.3		Y
Transmitter unwanted emissions in the OOB domain	Clause 4.3.1.9.3	FL=2400-2BW FH=2483.5+2BW	Y
Transmitter unwanted emissions in the spurious domain(Conducted)	Clause 4.3.1.10.3	30-12750	N
Transmitter unwanted emissions in the spurious domain(Radiated)			Y
<b>RECEIVER PARAMETERS</b>			
Spurious emissions (Conducted)	Clause 4.3.1.11.3	30-12750	N
Spurious emissions (Radiated)			Y
Receiver Blocking	Clause 4.3.1.12.3	2400-2483.5	Y
Geo-location capability	Clause 4.3.1.13.3	--	N



## 1.1 TEST FACTORY

Company Name:	Dongguan Funas Testing Technology Co., Ltd.
Address:	Room 105, 1/F.. Baohao Technology Building 1, No.15, Gongye West Road.Songshan Lake Hi-Tech Industrial Area, Dongguan, Guangdong, China
Telephone:	+86-769-27280901
Fax:	+86-769-27280901
Laboray Accreditations	
FCC Test Firm Registration Number: 514908 CNAS Number: L15566 Designation number: CN0127 A2LA accreditation number: 5545.01 ISED Number: 25801	

## 1.2 MEASUREMENT UNCERTAINTY

The reported uncertainty of measurement  $y \pm U$ , where expended uncertainty  $U$  is based on a standard uncertainty multiplied by a coverage factor of  $k=2$ , providing a level of confidence of approximately **95** %.

No.	Item	Uncertainty
1	RF power,conducted	$\pm 0.71$ dB
2	Spurious emissions,conducted	$\pm 0.63$ dB
3	Spurious emissions,radiated(>1G)	$\pm 2.25$ dB
4	Spurious emissions,radiated(<1G)	$\pm 2.21$ dB

## 2. GENERAL INFORMATION

### 2.1 GENERAL DESCRIPTION OF THE EUT

Product Name	Wireless speaker	
Brand Name	N/A	
Model Name	MO2210	
Series Model	N/A	
Model Difference	N/a	
Product Description	The EUT is a Wireless speaker	
	Operation Frequency	2402~2480 MHz
	Modulation Type	BT(1Mbps): GFSK BT EDR(2Mbps): $\pi/4$ -DQPSK BT EDR(3Mbps): 8DPSK
	Number Of Channel	79CH
	Bit Rate of Transmitter	1Mbps/2Mbps/3Mbps
	Antenna Designation	PCB Antenna
	Antenna Gain(Peak)	1.0dBi
	Based on the application, features, or specification exhibited in User's Manual, the EUT is considered as an ITE/Computing Device. More details of EUT technical specification, please refer to the User's Manual.	
Channel List	Refer to below	
Power Supply	INPUT:DC 5V 1A	
Battery	DC 3.7V	

**Note:**

1.For a more detailed features description, please refer to the manufacturer's specifications or the User's Manual.



2.	Channel	Frequency (MHz)
	00	2402
	01	2403
	02	2404
	.....	.....
	39	2441
	40	2442
	41	2443
	.....	.....
	77	2479
	78	2480

a) The type of modulation used by the equipment:

- FHSS
- other forms of modulation

b) In case of FHSS modulation:

- In case of non-Adaptive Frequency Hopping equipment:  
The number of Hopping Frequencies:
- In case of Adaptive Frequency Hopping Equipment:  
The maximum number of Hopping Frequencies: 79  
The minimum number of Hopping Frequencies: 79  
The (average) Dwell Time:

c) Adaptive / non-adaptive equipment:

- non-adaptive Equipment
- adaptive Equipment without the possibility to switch to a non-adaptive mode
- adaptive Equipment which can also operate in a non-adaptive mode

d) In case of adaptive equipment:

- The Channel Occupancy Time implemented by the equipment:
- The equipment has implemented an LBT based DAA mechanism
  - In case of equipment using modulation different from FHSS:
    - The equipment is Frame Based equipment
    - The equipment is Load Based equipment
    - The equipment can switch dynamically between Frame Based and Load Based equipment
- The CCA time implemented by the equipment: .....  $\mu$ s
- The value q as referred to in clause 4.3.2.5.2.2.2 .....
- The equipment has implemented an non-LBT based DAA mechanism
- The equipment can operate in more than one adaptive mode

e) In case of non-adaptive Equipment:

- The maximum RF Output Power (e.i.r.p.):.....dBm
- The maximum (corresponding) Duty Cycle: .....%
- Equipment with dynamic behavior, that behavior is described here. (e.g. the different combinations of duty cycle and corresponding power levels to be declared):

f) The worst case operational mode for each of the following tests:



- RF Output Power  
GFSK
  - Accumulated Transmit Time, Frequency Occupation & Hopping Sequence
  - GFSK  
Hopping Frequency Separation (only for FHSS equipment)  
GFSK
  - Occupied Channel Bandwidth  
GFSK
  - Transmitter unwanted emissions in the OOB domain  
GFSK
  - Transmitter unwanted emissions in the spurious domain  
GFSK
  - Receiver spurious emissions  
GFSK
    - Receiver Blocking  
GFSK
- g) The different transmit operating modes (tick all that apply):
- Operating mode 1: Single Antenna Equipment
    - Equipment with only 1 antenna
      - Equipment with 2 diversity antennas but only 1 antenna active at any moment in time
      - Smart Antenna Systems with 2 or more antennas, but operating in a (legacy) mode where only 1 antenna is used. (BT mode in smart antenna systems)
    - Operating mode 2: Smart Antenna Systems - Multiple Antennas without beam forming
      - Single spatial stream / Standard throughput / (BT mode)
      - High Throughput (> 1 spatial stream) using Occupied Channel Bandwidth 1
      - High Throughput (> 1 spatial stream) using Occupied Channel Bandwidth 2
      - NOTE: Add more lines if more channel bandwidths are supported.
    - Operating mode 3: Smart Antenna Systems - Multiple Antennas with beam forming
      - Single spatial stream / Standard throughput (BT mode)
      - High Throughput (> 1 spatial stream) using Occupied Channel Bandwidth 1
      - High Throughput (> 1 spatial stream) using Occupied Channel Bandwidth 2
      - NOTE: Add more lines if more channel bandwidths are supported.
- h) In case of Smart Antenna Systems:
- The number of Receive chains: .....
  - The number of Transmit chains: .....
    - symmetrical power distribution
    - asymmetrical power distribution
- In case of beam forming, the maximum beam forming gain: .....
- NOTE: Beam forming gain does not include the basic gain of a single antenna.
- i) Operating Frequency Range(s) of the equipment:
- Operating Frequency Range 1: 2402 MHz to 2480 MHz
  - Operating Frequency Range 2:  
NOTE: Add more lines if more Frequency Ranges are supported.
- j) Occupied Channel Bandwidth(s):
- Occupied Channel Bandwidth : 0.767 MHz  
Occupied Channel Bandwidth : 1.246 MHz  
NOTE: Add more lines if more channel bandwidths are supported.



- k) Type of Equipment (stand-alone, combined, plug-in radio device, etc.):
  - Stand-alone
  - Combined Equipment (Equipment where the radio part is fully integrated within another type of equipment)
  - Plug-in radio device (Equipment intended for a variety of host systems)
  - Other .....

l) The extreme operating conditions that apply to the equipment:

Operating temperature range:-10° C to 55° C

Operating voltage range: Power Supply or AC/DC adapter: DC 5V  
(Normal: DC 3.7V)

- Details provided are for the:
  - stand-alone equipment
  - combined (or host) equipment
  - test jig

m) The intended combination(s) of the radio equipment power settings and one or more antenna assemblies and their corresponding e.i.r.p levels:

• Antenna Type

PCB

Antenna Gain: 1.0dBi

If applicable, additional beamforming gain (excluding basic antenna gain): ..... dB

- Temporary RF connector provided
- No temporary RF connector provided
- Dedicated Antennas (equipment with antenna connector)
- Single power level with corresponding antenna(s)
- Multiple power settings and corresponding antenna(s)
  - Number of different Power Levels: .....
  - Power Level 1: ..... dBm
  - Power Level 2: ..... dBm
  - Power Level 3: ..... dBm

NOTE 1: Add more lines in case the equipment has more power levels.

NOTE 2: These power levels are conducted power levels (at antenna connector).

•For each of the Power Levels, provide the intended antenna assemblies, their, corresponding gains (G) and the resulting e.i.r.p. levels also taking into account the beamforming gain (Y) if applicable

**Power Level 1:** ..... dBm

Number of antenna assemblies provided for this power level: .....

Assembly #	Gain (dBi)	e.i.r.p.(dBm)	Part number or model name
1			
2			
3			
4			

NOTE: Add more rows in case more antenna assemblies are supported for this power level.



Power Level 2: ..... dBm

Number of antenna assemblies provided for this power level: .....

Assembly #	Gain (dBi)	e.i.r.p.(dBm)	Part number or model name
1			
2			
3			
4			

NOTE: Add more rows in case more antenna assemblies are supported for this power level.

Power Level 3: ..... dBm

Number of antenna assemblies provided for this power level: .....

Assembly #	Gain (dBi)	e.i.r.p.(dBm)	Part number or model name
1			
2			
3			
4			

NOTE: Add more rows in case more antenna assemblies are supported for this power level.

n) The nominal voltages of the stand-alone radio equipment or the nominal voltages of the combined (host) equipment or test jig in case of plug-in devices:

Details provided are for the: stand-alone equipment

combined (or host) equipment

test jig Supply Voltage

AC mains State AC voltage 100-240 V

DC State DC voltage :5V

In case of DC, indicate the type of power source

Internal Power Supply

External Power Supply or AC/DC adapter

Battery: 3.7V

Other: .....

o) Describe the test modes available which can facilitate testing:

The EUT can entering Engineering Command by Enter **###3646633###**

p) The equipment type (e.g. Bluetooth®, IEEE 802.11™ [i.3], proprietary, etc.):

BT

q) If applicable, the statistical analysis referred to in clause 5.4.1 q)

(to be provided as separate attachment)

r) If applicable, the statistical analysis referred to in clause 5.4.1 r)

(to be provided as separate attachment)

s) Geo-location capability supported by the equipment:

Yes

The geographical location determined by the equipment as defined in clause 4.3.1.13.2 or clause 4.3.2.12.2 is not accessible to the user

No

t) Describe the minimum performance criteria that apply to the equipment (see clause 4.3.1.12.3 or clause 4.3.2.11.3):



## 2.2 ENVIRONMENTAL CONDITIONS FOR TESTING

Test Condition	Temperature(°C)	Voltage(V)	Relative Humidity (%)
NT/NV	24.2	5V	37
LT/NV	-10	5V	/
HT/NV	55	5V	/

Note:

- (1) The HT 55°C and LT -10°C was declare by manufacturer, The EUT couldn't be operate normally with higher or lower temperature.
- (2) NV: Normal Voltage; NT: Normal Temperature.
- (3) LT: Low Extreme Test Temperature; HT: High Extreme Test Temperature.

## 2.3 TEST MODE

The EUT has been tested as an independent unit together with other necessary accessories or support units. The following support units or accessories were used to form a representative test configuration during the tests.

E-1 EUT
------------

The EUT was programmed to be in continuously transmitting mode.

Test Channel	EUT Channel	Test Frequency (MHz)
lowest	CH00	2402
middle	CH39	2441
highest	CH78	2480

## 2.4 DESCRIPTION OF NECESSARY ACCESSORIES AND SUPPORT UNITS

The EUT has been tested as an independent unit together with other necessary accessories or support units. The following support units or accessories were used to form a representative test configuration during the tests.

### Necessary accessories

Item	Equipment	Mfr/Brand	Model/Type No.	Serial No.	Note
1	laptop	Lenovo	E495	N/A	N/A

### Support units

Item	Equipment	Mfr/Brand	Model/Type No.	Serial No.	Note
N/A	N/A	N/A	N/A	N/A	N/A

#### Note:

- (1) The support equipment was authorized by Declaration of Confirmation.
- (2) For detachable type I/O cable should be specified the length in cm in 『Length』 column.



## 2.5 EQUIPMENTS LIST

Kind of Equipment	Manufacturer	Type No.	Serial No.	Last Calibration	Calibrated Until
Bilog Antenna	TESEQ	CBL6111D	34678	2023.08.29	2024.08.28
Horn Antenna	SCHWARZBECK	BBHA 9120D	9120D-1343	2023.08.29	2024.08.28
Pre-Amplifier(0.1M-3GHz)	EM	EM330	060665	2023.08.29	2024.08.28
Pre-Amplifier(1G-18GHz)	SKET	LNPA-01018G-45	SK2018080901	2023.08.29	2024.08.28
Wireless Communications Test Set	R&S	CMW 500	133884	2023.08.29	2024.08.28
Signal Analyzer	Agilent	N9020A	MY51110105	2023.08.29	2024.08.28
Temperature & Humidity	HH660	Mieo	N/A	2023.08.29	2024.08.28
turn table	EM	SC100_1	60531	N/A	N/A
Antenna mast	EM	SC100	N/A	N/A	N/A
AC Power Source	APC	KDF-11010G	F214050035	N.C.R	N.C.R

## RF Connected Test equipment

Kind of Equipment	Manufacturer	Type No.	Serial No.	Last Calibration	Calibrated Until
USB RF power sensor	DARE	RPR3006W	15I00041SNO03	2023.08.29	2024.08.28
MIMO Power measurement test Set	Keysight	U2021XA	MY55520005	2023.08.29	2024.08.28
			MY55520006	2023.08.29	2024.08.28
			MY56120038	2023.08.29	2024.08.28
			MY56280002	2023.08.29	2024.08.28
Signal Generator	Agilent	N5182A	MY46240556	2023.08.29	2024.08.28
Signal Analyzer	Agilent	N9020A	MY49100060	2023.08.29	2024.08.28
Universal Radio communication tester	R&S	CMU200	11764	2023.08.29	2024.08.28
Wireless Communications Test Set	R&S	CMW 500	133884	2023.08.29	2024.08.28
Temperature & Humidity	HH660	Mieo	N/A	2023.08.29	2024.08.28
Temperature& Humidity test chamber	Safety test	GDS-250	171200018	2023.08.29	2024.08.28
programmable power supply	Agilent	E3642A	MY40002025	2023.08.29	2024.08.28
Attenuator	HP	8494B	DC-18G	2023.08.29	2024.08.28
AC Power Source	APC	KDF-11010G	F214050035	N.C.R	N.C.R
Router	WAVLINK	WL-WN575A2	WL1512260336	N.C.R	N.C.R

### 3. RF OUTPUT POWER

#### 3.1 LIMIT

##### FHSS:

The maximum RF output power for adaptive Frequency Hopping equipment shall be equal to or less than 20 dBm. The maximum RF output power for non-adaptive Frequency Hopping equipment shall be declared by the manufacturer. See clause 5.4.1 m). The maximum RF output power for this equipment shall be equal to or less than the value declared by the manufacturer. This declared value shall be equal to or less than 20 dBm.

##### Other than FHSS:

For adaptive equipment using wide band modulations other than FHSS, the maximum RF output power shall be 20 dBm. The maximum RF output power for non-adaptive equipment shall be declared by the supplier and shall not exceed 20 dBm. See clause 5.4.1 m). For non-adaptive equipment using wide band modulations other than FHSS, the maximum RF output power shall be equal to or less than the value declared by the supplier.

This limit shall apply for any combination of power level and intended antenna assembly.

Limit
20 dBm

Between the start and stop times of each individual burst calculate the RMS power over the burst using the formula below. Save these  $P_{burst}$  values, as well as the start and stop times for each burst.

$$P_{burst} = \frac{1}{k} \sum_{n=1}^k P_{sample}(n)$$

with 'k' being the total number of samples and 'n' the actual sample number

#### 3.2 TEST PROCEDURES

1. Please refer to ETSI EN 300 328 (V2.2.2) clause 5.4.2.1 for the test conditions.
2. Please refer to ETSI EN 300 328 (V2.2.2) clause 5.4.2.2 for the measurement method.
  - a) Use a fast power sensor suitable for 2.4 GHz and capable of 1 MS/s.
 

Use the following settings:

    - Sample speed 1 MS/s or faster.
    - The samples must represent the power of the signal.
    - Measurement duration: For non-adaptive equipment: equal to the observation period defined in b)
  - b) Clause 4.3.1.3.2 or clause 4.3.2.4.2. For adaptive equipment, the measurement duration shall be long enough to ensure a minimum number of bursts (at least 10) is captured
  - c) Print the plots from power sensor by used power sensor on PC, select the max result and record it.

#### 3.3 TEST SETUP

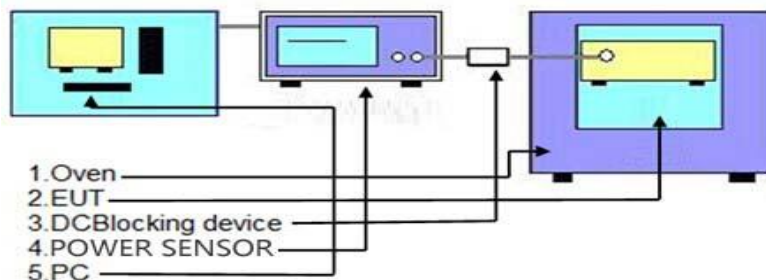

### 3.4 TEST RESULT

Modulation		GFSK		
Test conditions		Normal	Extreme	
			LTNV	HTNV
EIRP (dBm)	Hopping	1.78	1.78	1.77
	Max. E.I.R.P	1.78		
Limit		20dBm (-10dBW)		
Burst plot		> 10		
Result		Complies		

Note: Average EIRP Power = Burst power + the antenna gain value

#### GFSK HOPPING

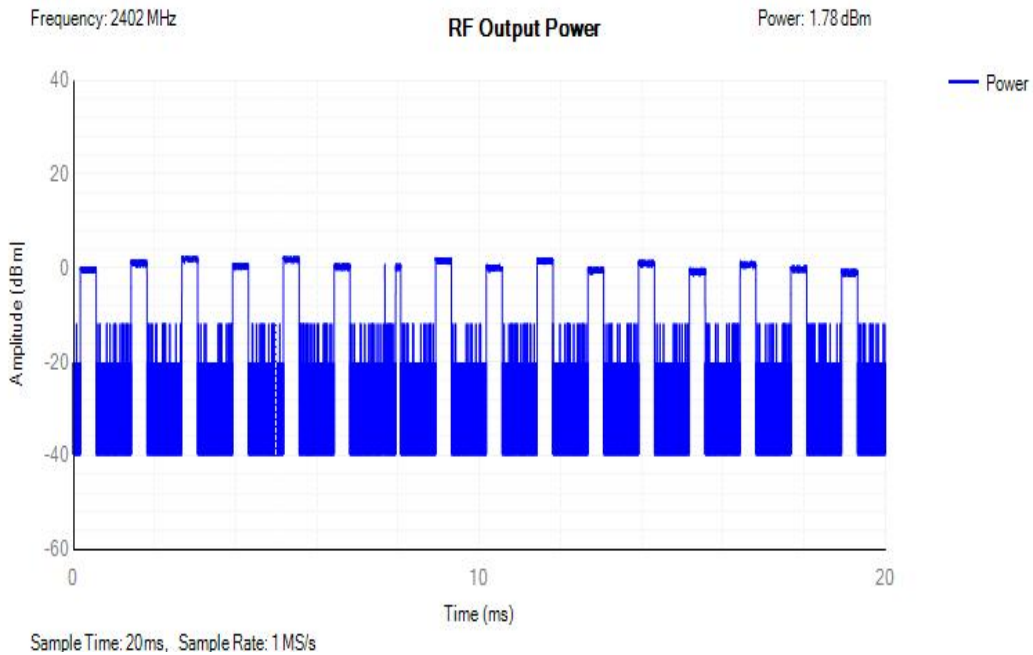

Modulation		$\pi/4$ DQPSK		
Test conditions		Normal	Extreme	
			LTVN	HTNV
EIRP (dBm)	Hopping	1.71	1.71	1.70
	Max. E.I.R.P	1.71		
Limit		20dBm (-10dBW)		
Burst plot		> 10		
Result		Complies		

Note: Average EIRP Power = Burst power + the antenna gain value

### $\pi/4$ -DQPSK HOPPING

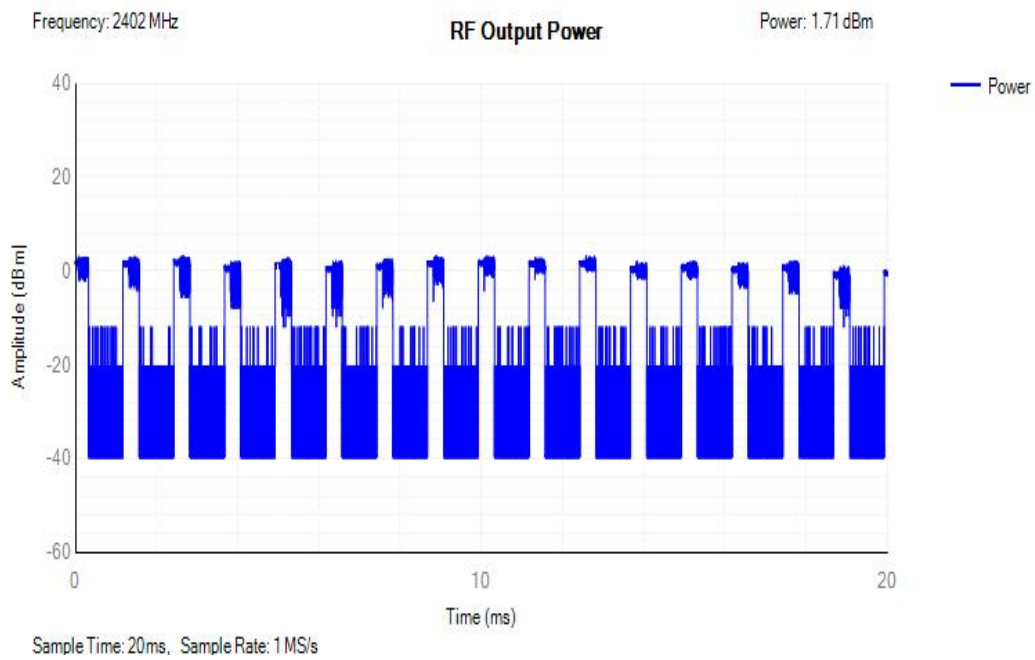

Modulation		8DPSK		
Test conditions		Normal	Extreme	
			LTVN	HTNV
EIRP (dBm)	Hopping	3.39	3.38	3.38
	Max. E.I.R.P	3.39		
Limit		20dBm (-10dBW)		
Burst plot		> 10		
Result		Complies		

Note: Average EIRP Power = Burst power + the antenna gain value

### 8DPSK HOPPING

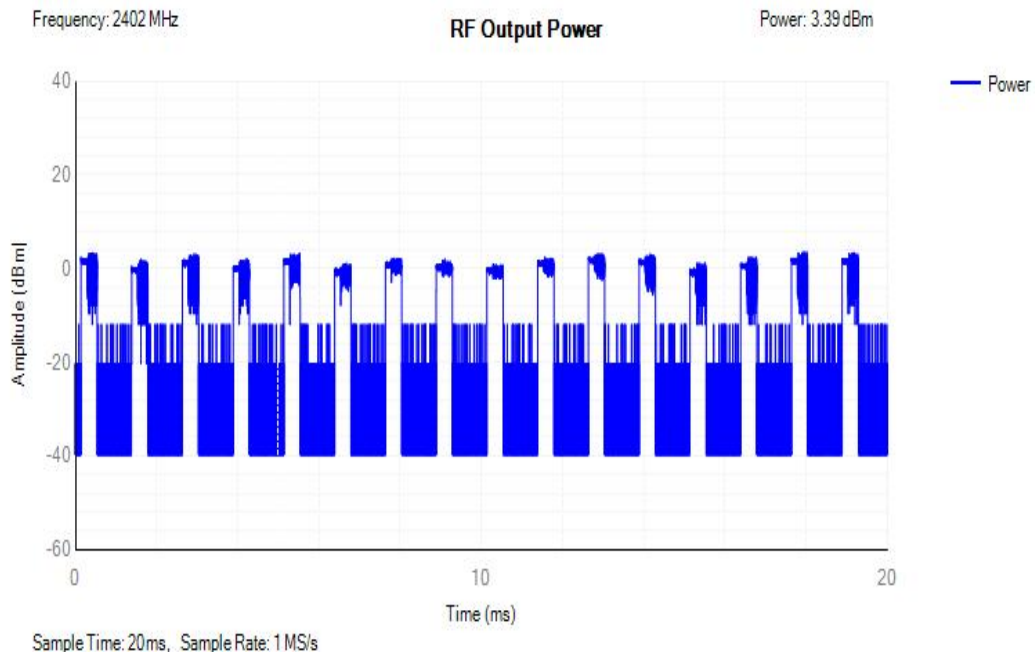

## 4. ACCUMULATED TRANSMIT TIME, FREQUENCY OCCUPATION & HOPPING SEQUENCE

### 4.1 LIMIT

#### Non-adaptive frequency hopping systems

The Accumulated Transmit Time on any hopping frequency shall not be greater than 15 ms within any observation period of 15 ms multiplied by the minimum number of hopping frequencies (N) that have to be used.

Non-adaptive medical devices requiring reverse compatibility with other medical devices placed on the market that are compliant with version 2.0.2 or earlier versions of ETSI EN 300 328, are allowed to have an operating mode in which the maximum Accumulated Transmit Time is 400 ms within any observation period of 400 ms multiplied by the minimum number of hopping frequencies (N) that have to be used, only when communicating to these legacy devices already placed on the market. In order for the equipment to comply with the Frequency Occupation requirement, it shall meet either of the following two options:

Option 1: Each hopping frequency of the hopping sequence shall be occupied at least once within a period not exceeding four times the product of the dwell time and the number of hopping frequencies in use.

Option 2: The occupation probability for each frequency shall be between  $((1 / U) \times 25 \%)$  and 77 % where U is the number of hopping frequencies in use.

The hopping sequence(s) shall contain at least N hopping frequencies where N is 15 or 15 divided by the minimum Hopping Frequency Separation in MHz, whichever is the greater.

#### Adaptive frequency hopping equipment

Adaptive Frequency Hopping equipment shall be capable of operating over a minimum of 70 % of the band specified in clause 1.

The Accumulated Transmit Time on any hopping frequency shall not be greater than 400 ms within any observation period of 400 ms multiplied by the minimum number of hopping frequencies (N) that have to be used. In order for the equipment to comply with the Frequency Occupation requirement, it shall meet either of the following two options:

Option 1: Each hopping frequency of the hopping sequence shall be occupied at least once within a period not exceeding four times the product of the dwell time and the number of hopping frequencies in use.

Option 2: The occupation probability for each frequency shall be between  $((1 / U) \times 25 \%)$  and 77 % where U is the number of hopping frequencies in use.

The hopping sequence(s) shall contain at least N hopping frequencies at all times, where N is 15 or 15 divided by the minimum Hopping Frequency Separation in MHz, whichever is the greater.



### Other Requirements

For non-Adaptive Frequency Hopping equipment, from the N hopping frequencies defined in clause 4.3.1.4.3.1 above, the equipment shall transmit on at least one hopping frequency while other hopping frequencies are blacklisted. For equipment that blacklists one or more hopping frequencies, these blacklisted frequencies are considered as active transmitting for the calculation of the MU factor of the equipment. See also clause 5.4.2.2.1.3 step 4, second bullet item and clause 5.4.2.2.1.4 step 3, note 2. For Adaptive Frequency Hopping equipment, from the N hopping frequencies defined in clause 4.3.1.4.3.2 above, the equipment shall consider at least one hopping frequency for its transmissions. Providing that there is no interference present on this frequency with a level above the detection threshold defined in clause 4.3.1.7.2.2 point 5 or clause 4.3.1.7.3.2 point 5, then the equipment shall have transmissions on this frequency. For non-Adaptive Frequency Hopping equipment, when not transmitting on a hopping frequency, the equipment has to occupy that frequency for the duration of the typical dwell time (see also definition for blacklisted frequency in clause 3.1). For Adaptive Frequency Hopping equipment using LBT based DAA, if a signal is detected during the CCA, the equipment may jump immediately to the next frequency in the hopping sequence (see clause 4.3.1.7.2.2 point 2) provided the limit for maximum dwell is respected.

### 4.2 TEST PROCEDURE

1. Please refer to ETSI EN 300 328 (V2.2.2) clause 5.4.4.1 for the test conditions.
2. Please refer to ETSI EN 300 328 (V2.2.2) clause 5.4.4.2 for the measurement method.
  - a) Set EUT work in hopping mode;
  - b) Centre Frequency: Equal to the hopping frequency being investigated
  - c) Frequency Span: 0 Hz
  - d) RBW: ~ 50 % of the Occupied Channel Bandwidth (383.5K for 1M, 623K for 3M)
  - e) VBW: ≥ RBW (383.5KHz for 1M, 623KHz for 3M)
  - f) Detector Mode: RMS
  - g) Sweep time: Equal to the applicable observation period (see clause 4.3.1.4.3.1 or clause 4.3.1.4.3.2)
  - h) Number of sweep points: 30000
  - j) Trace mode: Clear / Write
  - k) Trigger: Free Run

### 4.3 TEST SETUP

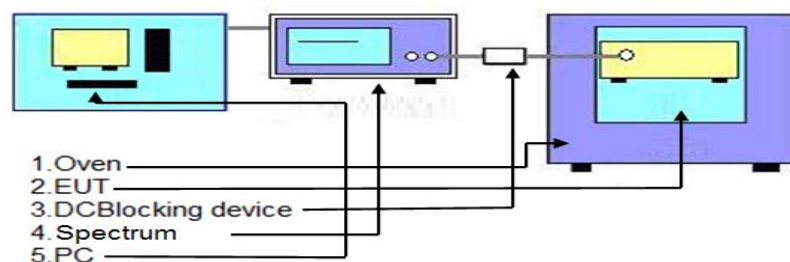



### 4.4 TEST RESULT

#### Accumulated Transmit Time

Condition	Mode	Frequency(MHz)	Pulse Time(ms)	Accumulated Transmit Time(ms)	Limit(ms)	Sweep Time(ms)	Burst Number	Results
NVNT	1DH5	2402	1.645	251.685	400	31600	153	Pass
NVNT	1DH5	2441	1.645	240.170	400	31600	146	Pass
NVNT	1DH5	2480	1.645	238.525	400	31600	145	Pass
NVNT	2DH5	2402	3.692	369.200	400	31600	100	Pass
NVNT	2DH5	2441	2.9	298.700	400	31600	103	Pass
NVNT	2DH5	2480	2.908	316.972	400	31600	109	Pass
NVNT	3DH5	2402	0.904	90.400	400	31600	100	Pass
NVNT	3DH5	2441	0.904	91.304	400	31600	101	Pass
NVNT	3DH5	2480	0.904	98.536	400	31600	109	Pass

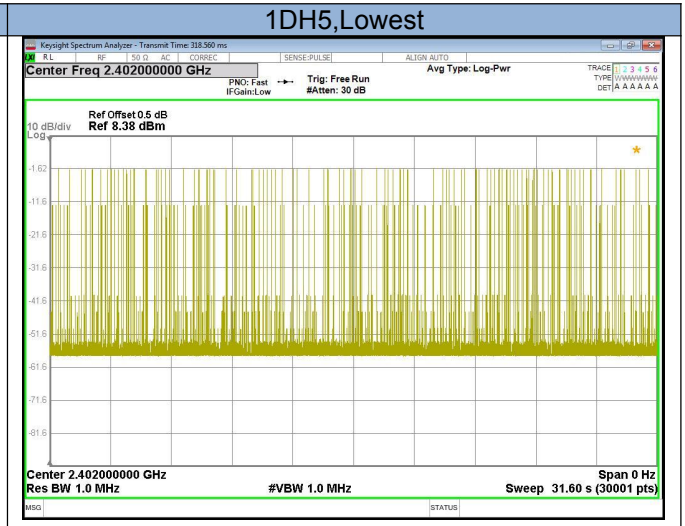
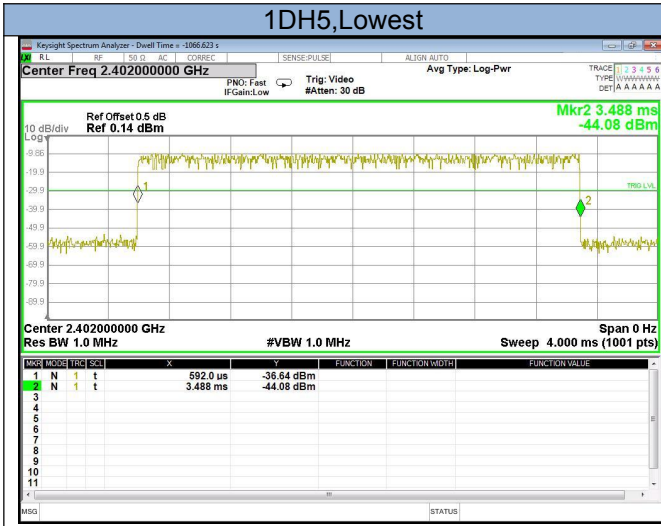

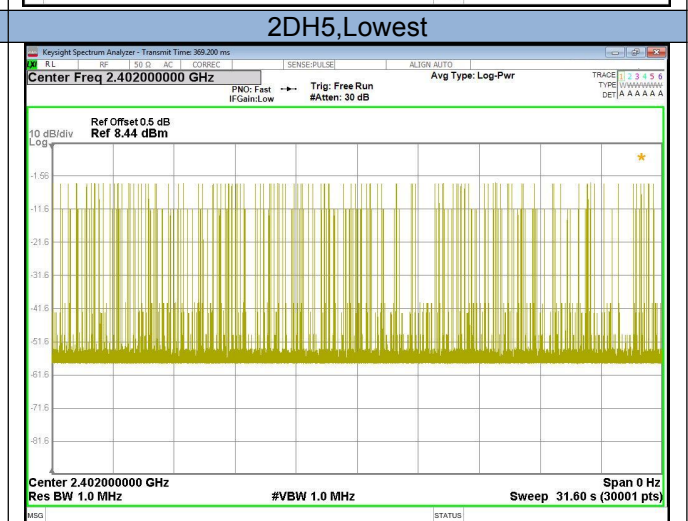
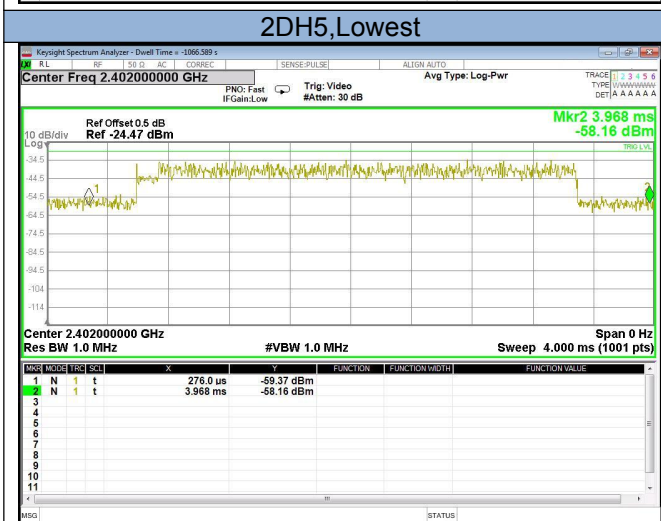
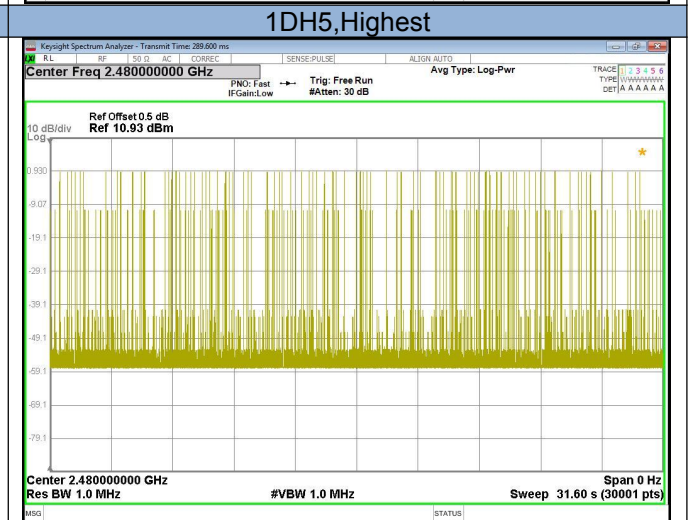
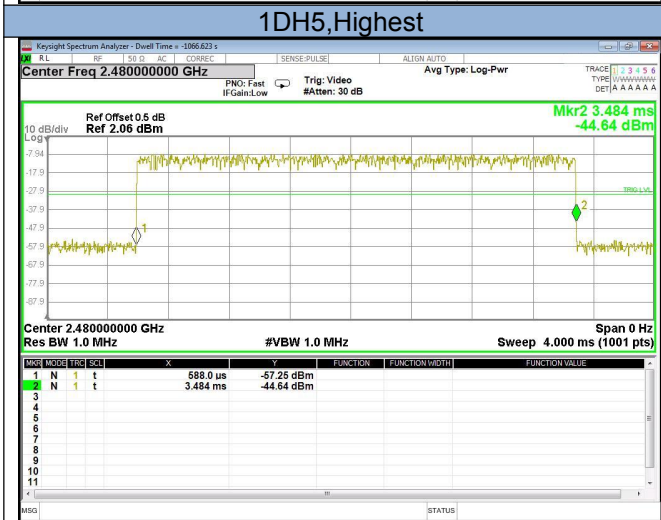
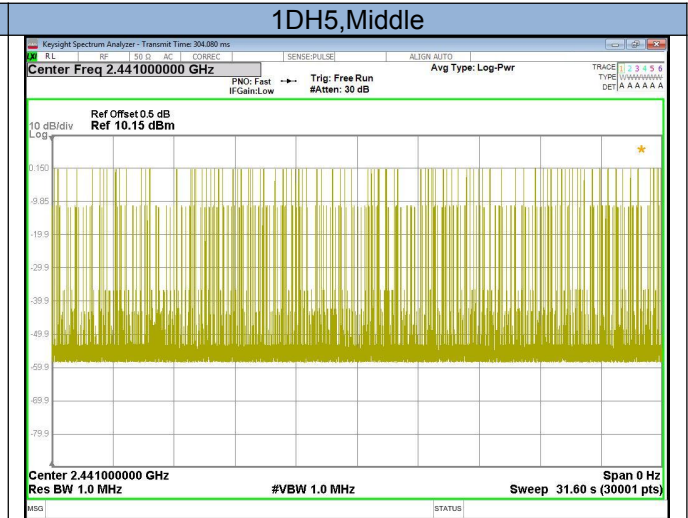
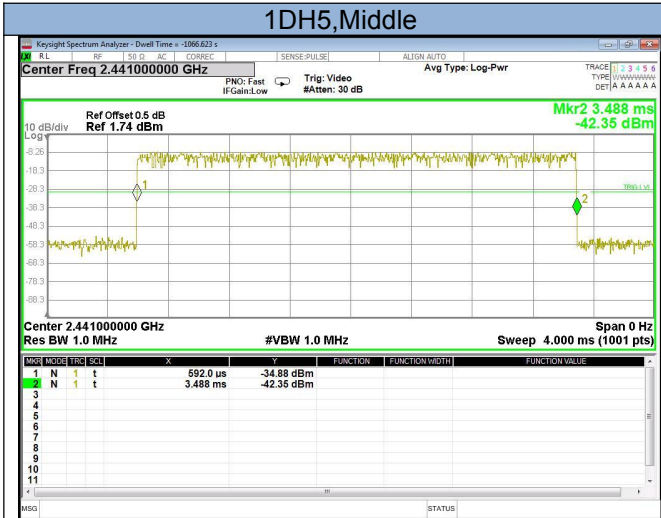

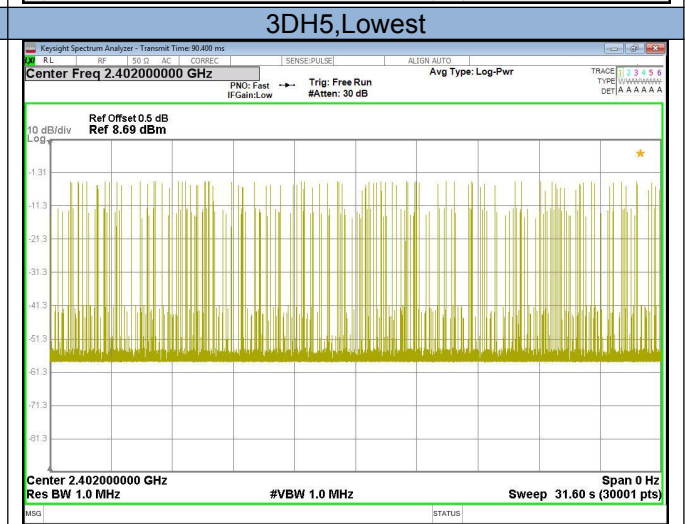
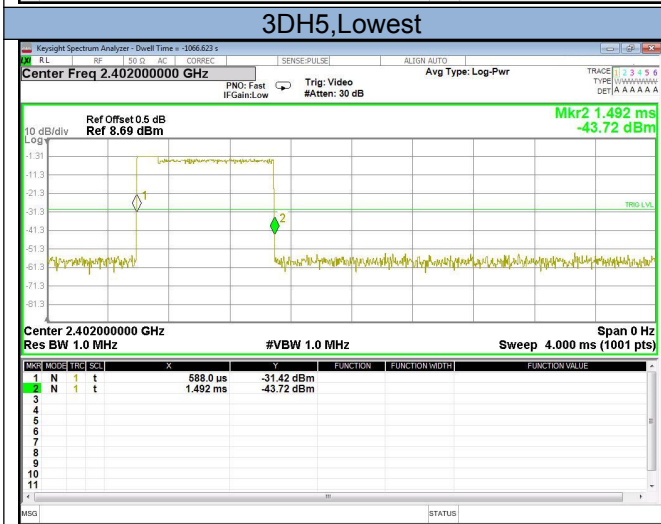
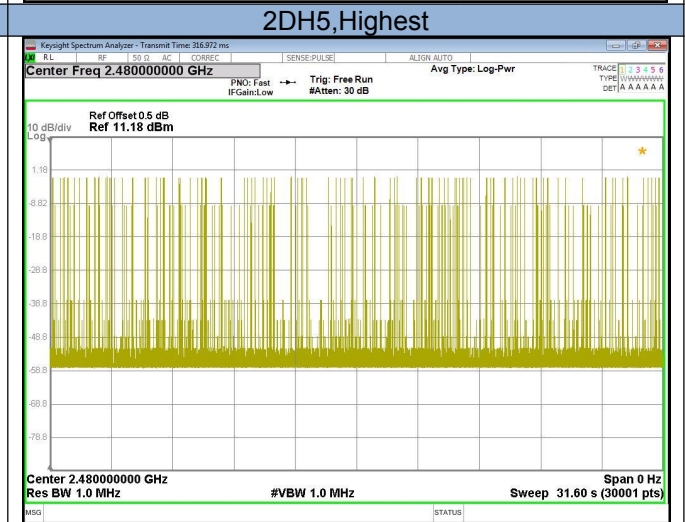
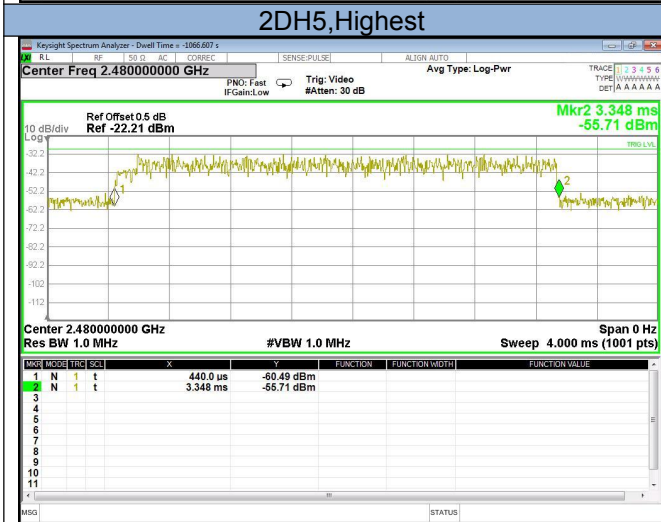
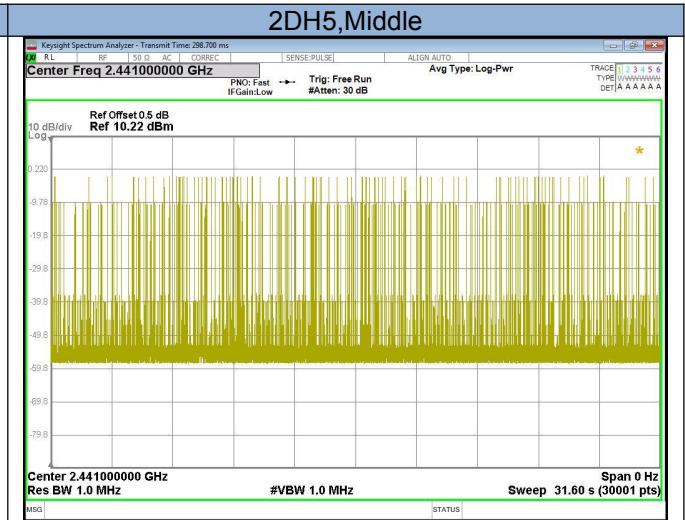
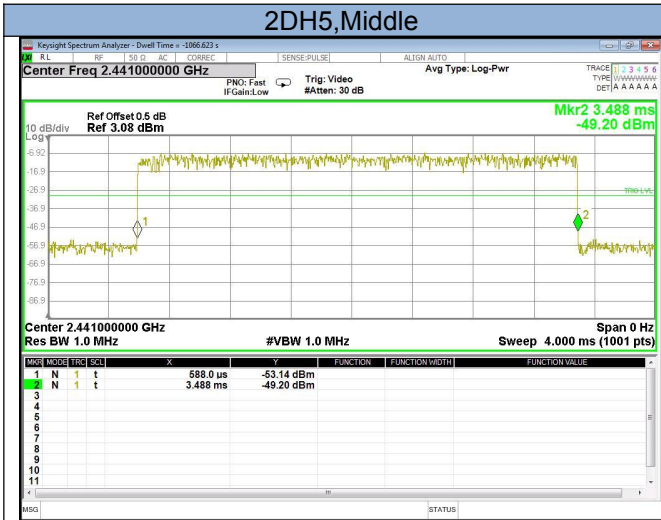



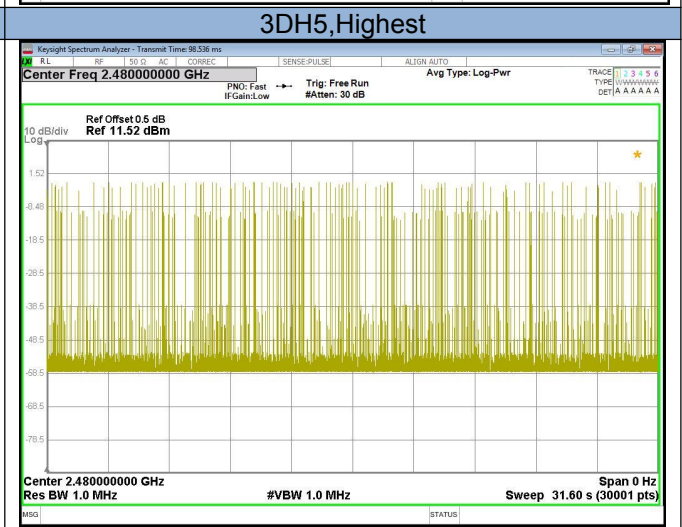
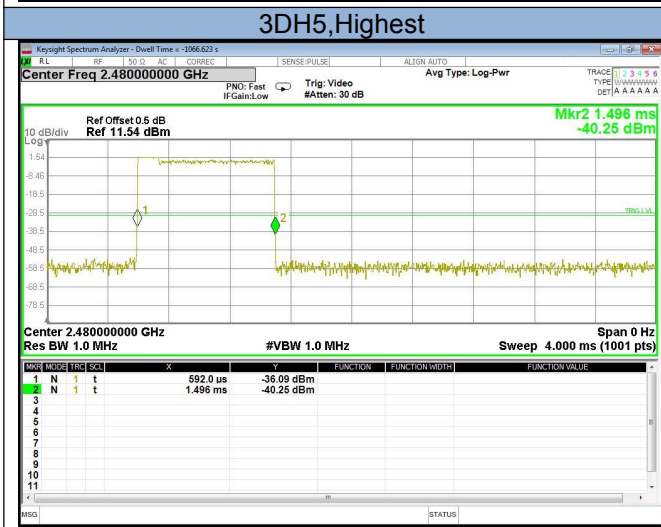
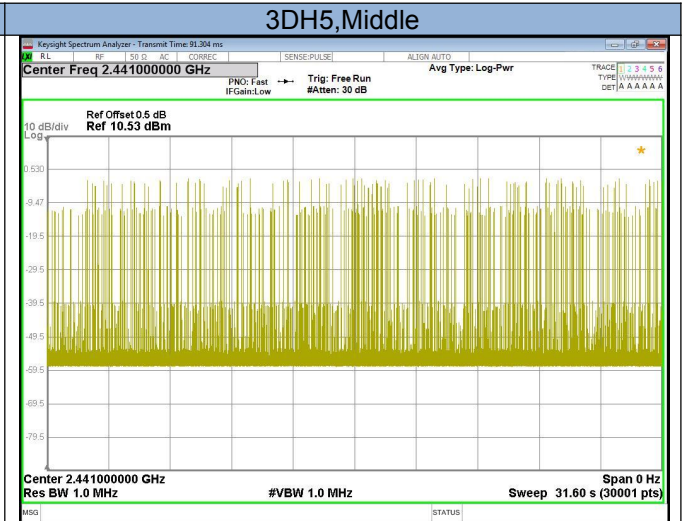
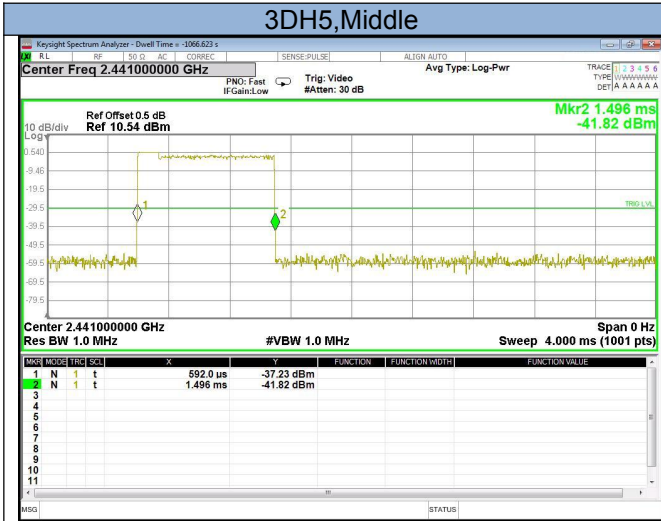



Frequency Occupation

Frequency Occupation							
Condition	Mode	Frequency(MHz)	Frequency Occupation(ms)	Limit(ms)	Sweep Time(ms)	Burst Number	Results
NVNT	1DH5	2402	2.896	>0	915.136	1	Pass
NVNT	1DH5	2441	2.896	>0	915.136	8	Pass
NVNT	1DH5	2480	2.896	>0	915.136	3	Pass
NVNT	2DH5	2402	3.692	>0	1166.672	7	Pass
NVNT	2DH5	2441	2.9	>0	916.400	8	Pass
NVNT	2DH5	2480	2.908	>0	918.928	11	Pass
NVNT	3DH5	2402	0.904	>0	285.664	3	Pass
NVNT	3DH5	2441	0.904	>0	285.664	3	Pass
NVNT	3DH5	2480	0.904	>0	285.664	2	Pass

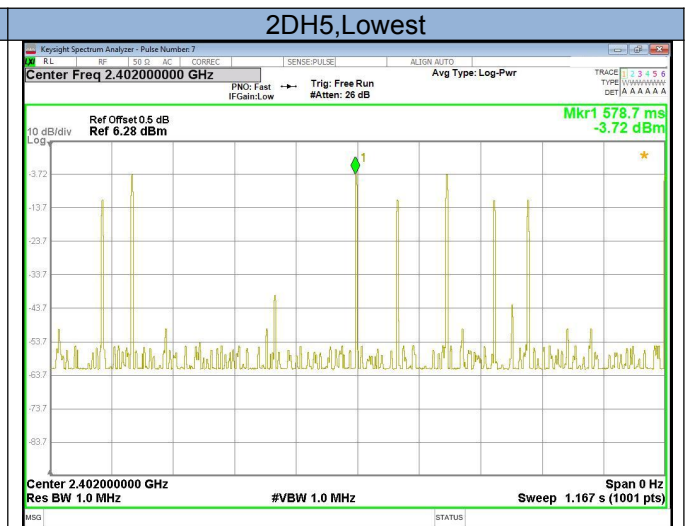
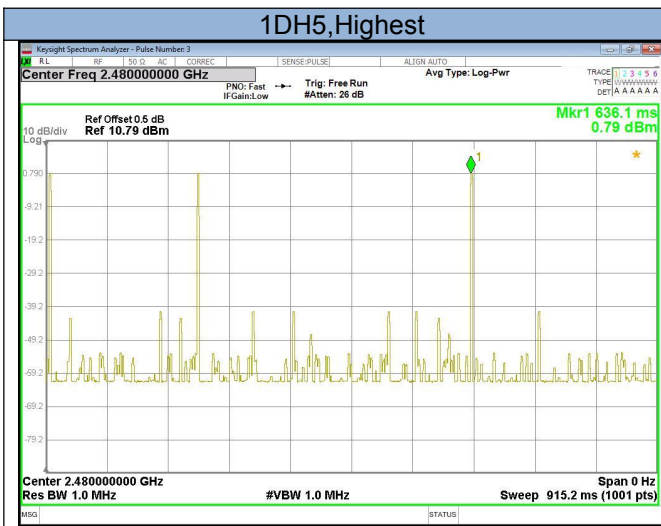
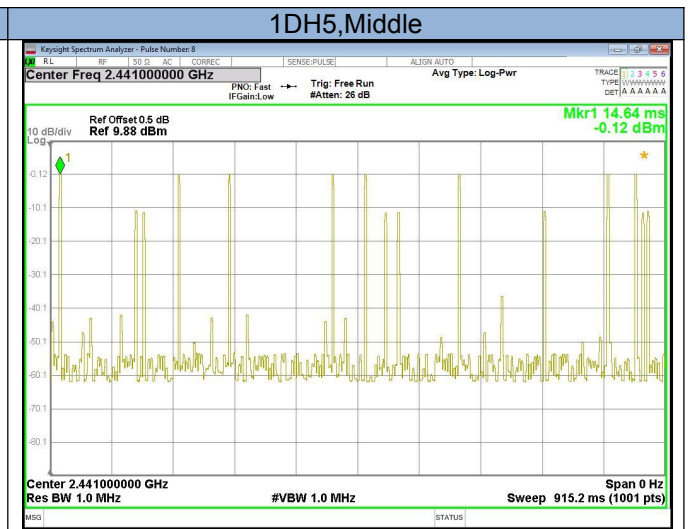
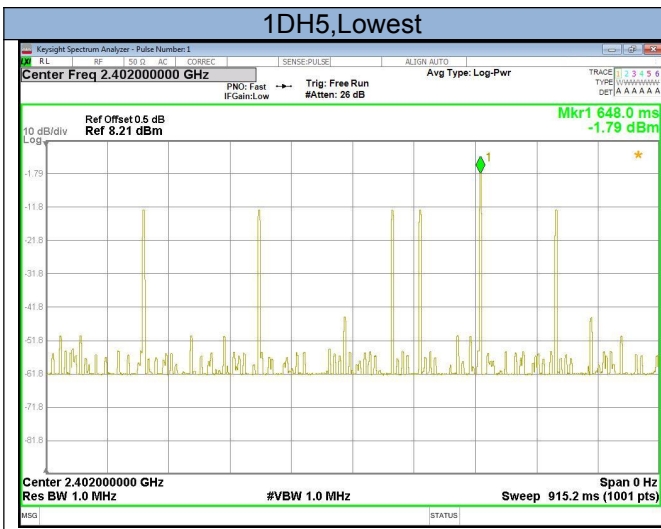

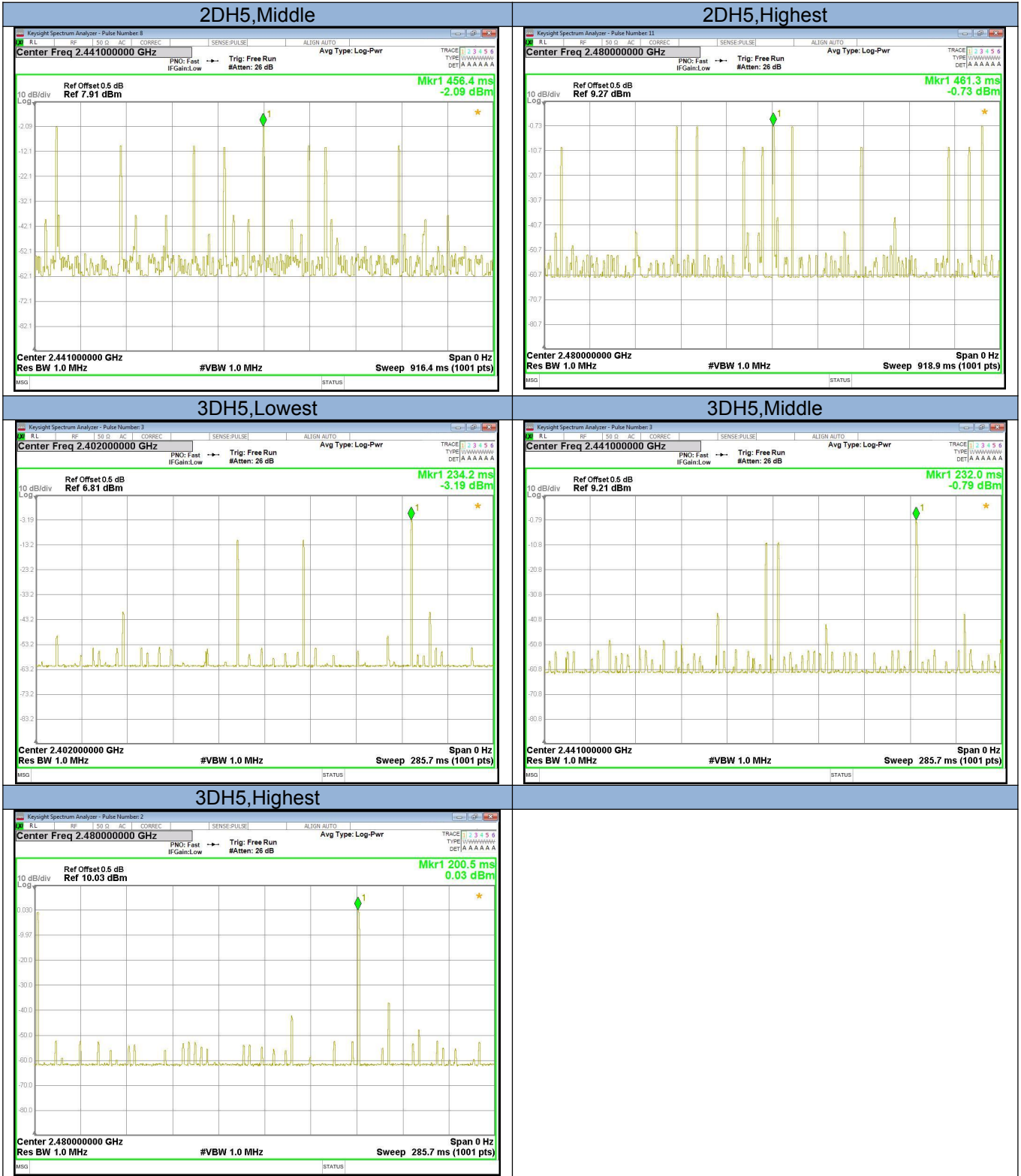



Hopping Sequence

Condition	Mode	Band Width(MHz)	Hopping Number	Limit	Sequence(%)	Limit Hopping Sequence(%)	Results
NVNT	1DH3	80.745	79	15	96.700	70	Pass
NVNT	2DH3	81.079	79	15	97.100	70	Pass
NVNT	1DH5	80.745	79	15	96.700	70	Pass
NVNT	2DH5	81.079	79	15	97.100	70	Pass
NVNT	1DH1	80.745	79	15	96.700	70	Pass
NVNT	2DH1	81.079	79	15	97.100	70	Pass

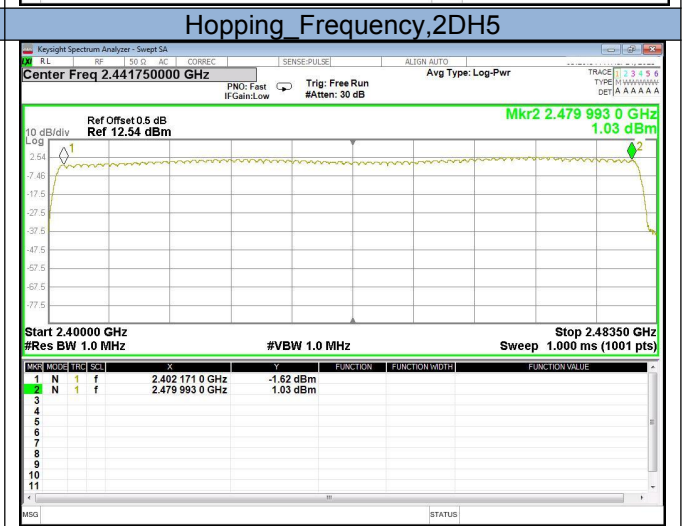
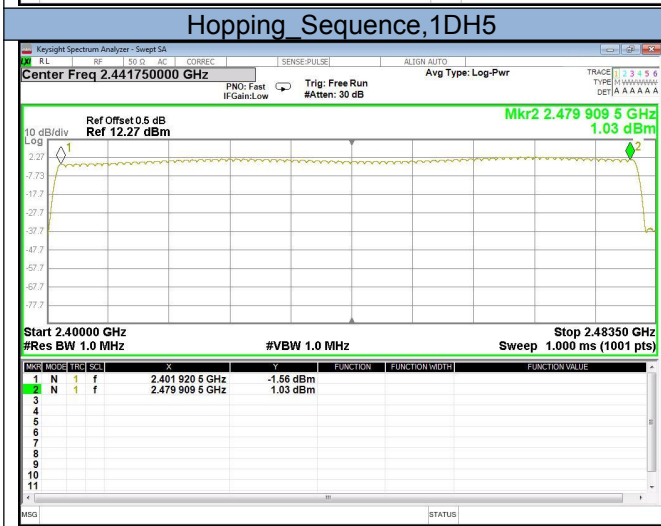
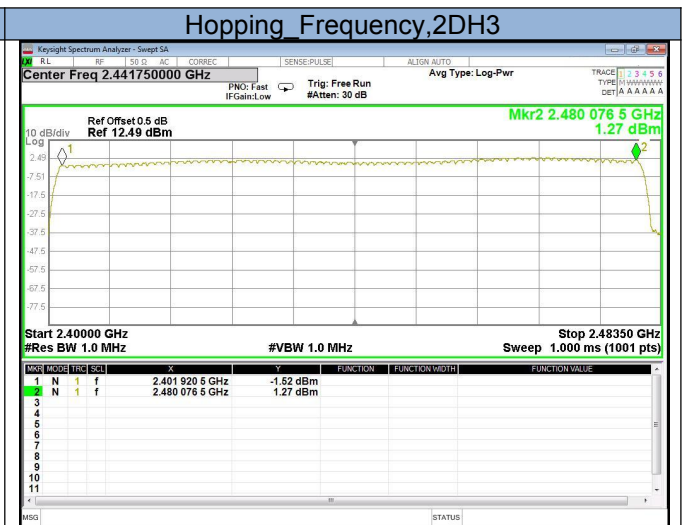
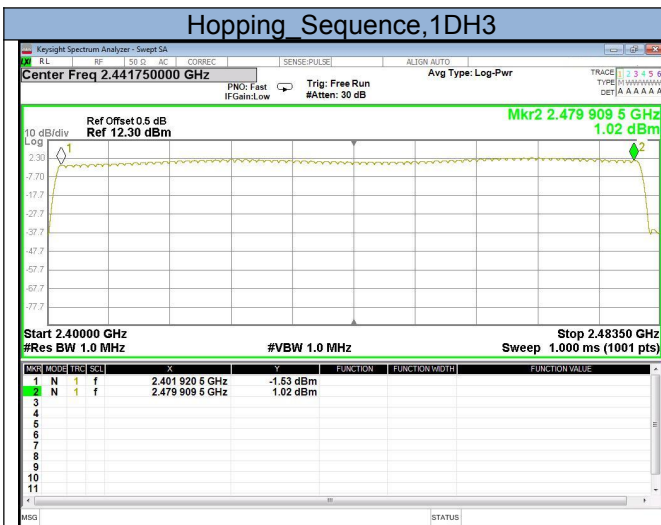



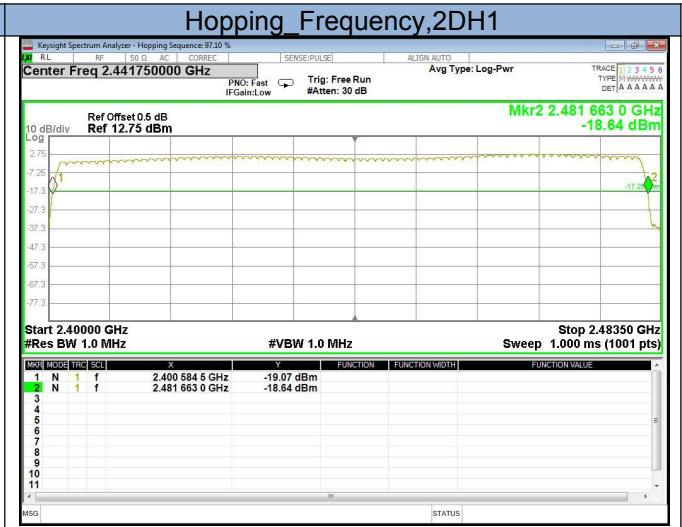
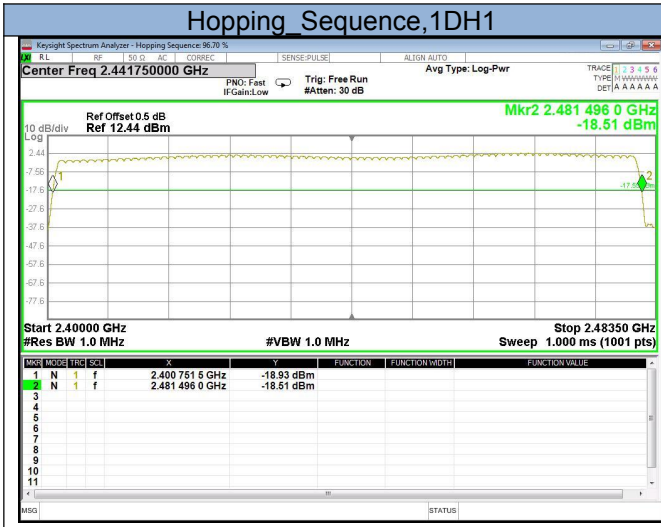

## 5. HOPPING FREQUENCY SEPARATION

### 5.1 LIMIT

#### a. Non-adaptive frequency hopping systems

For non-adaptive Frequency Hopping equipment, the Hopping Frequency Separation shall be equal to or greater than the Occupied Channel Bandwidth (see clause 4.3.1.8), with a minimum separation of 100 kHz.

For equipment with a maximum declared RF Output power level of less than 10 dBm e.i.r.p. or for non-adaptive Frequency Hopping equipment operating in a mode where the RF Output power is less than 10 dBm e.i.r.p. only the minimum Hopping Frequency Separation of 100 kHz applies.

#### b. Adaptive frequency hopping systems

For adaptive Frequency Hopping equipment, the minimum Hopping Frequency Separation shall be 100 kHz.

Adaptive Frequency Hopping equipment that switched to a non-adaptive mode for one or more hopping frequencies because interference was detected on these hopping frequencies with a level above the threshold level defined in clause 4.3.1.7.2.2, point 5 or clause 4.3.1.7.3.2, point 5, is allowed to continue to operate with a minimum Hopping Frequency Separation of 100 kHz as long as the interference remains present on these hopping frequencies. The equipment shall continue to operate in an adaptive mode on other hopping frequencies.

Adaptive Frequency Hopping equipment which decided to operate in a non-adaptive mode on one or more hopping frequencies without the presence of interference, shall comply with the limit in clause 4.3.1.5.3.1 for these hopping frequencies as well as with all other requirements applicable to non-adaptive frequency hopping equipment.

### 5.2 TEST PROCEDURE

a. Please refer to ETSI EN 300 328 (V2.1.1) clause 5.4.5.1 for the test conditions.

b. Please refer to ETSI EN 300 328 (V2.1.1) clause 5.4.5.2 for the measurement method.

- Centre Frequency: Centre of the two adjacent hopping frequencies
- Frequency Span: Sufficient to see the complete power envelope of both hopping frequencies
- RBW: 1 % of the Span
- RBW: 30K
- VBW: 100K
- Detector Mode: RMS
- Trace Mode: Max Hold
- Sweep time: 1S

### 5.3 TEST SETUP

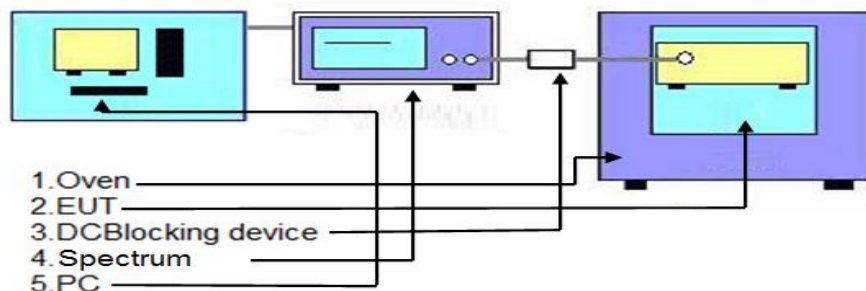

5.4 TEST RESULT

Hopping Frequency Separation					
Condition	Mode	Frequency(MHz)	Ch Separation(kHz)	Limit(kHz)	Result
NVNT	1DH1	2402	1000.0000	>100	Pass
NVNT	1DH1	2441	1002.0000	>100	Pass
NVNT	1DH1	2480	994.0000	>100	Pass
NVNT	2DH1	2402	1154.0000	>100	Pass
NVNT	2DH1	2441	1002.0000	>100	Pass
NVNT	2DH1	2480	1000.0000	>100	Pass
NVNT	3DH1	2402	1012.0000	>100	Pass
NVNT	3DH1	2441	1008.0000	>100	Pass
NVNT	3DH1	2480	1016.0000	>100	Pass

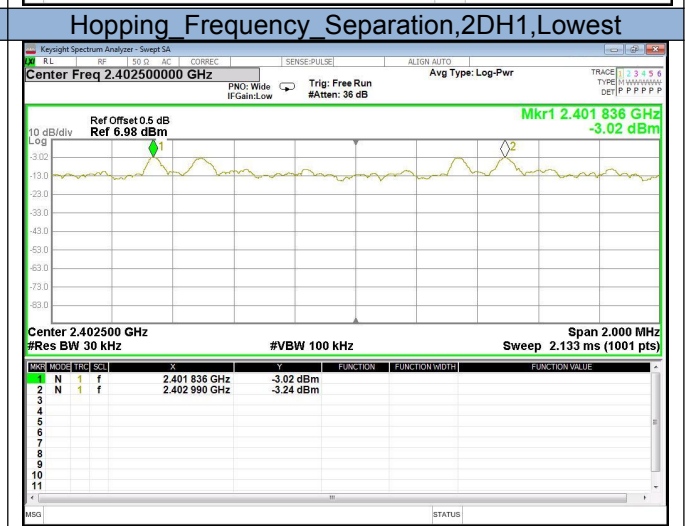
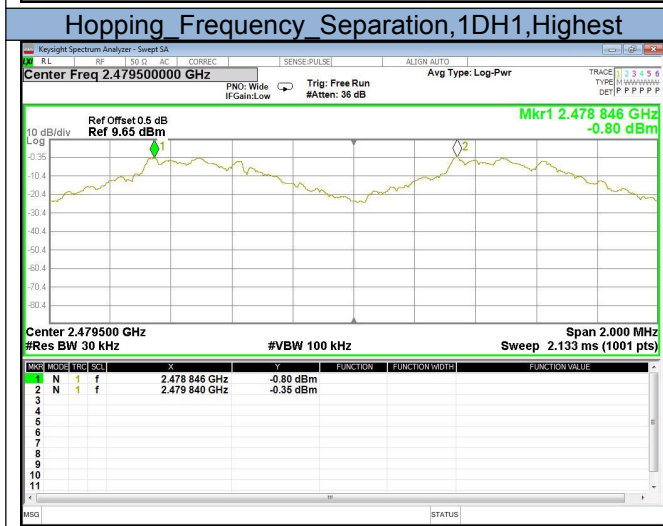
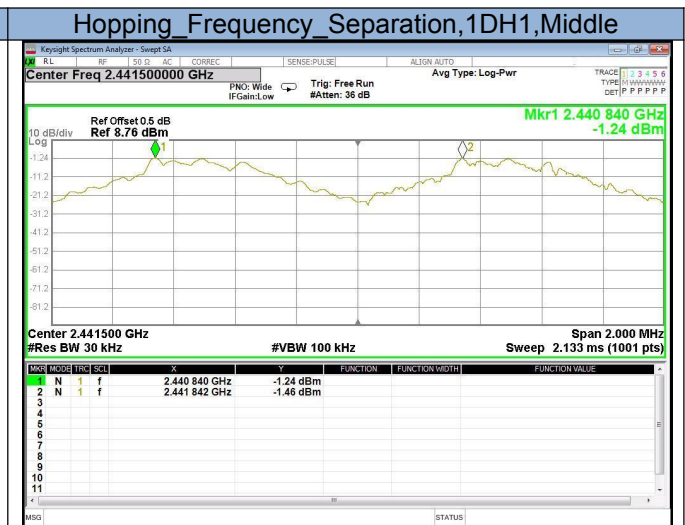
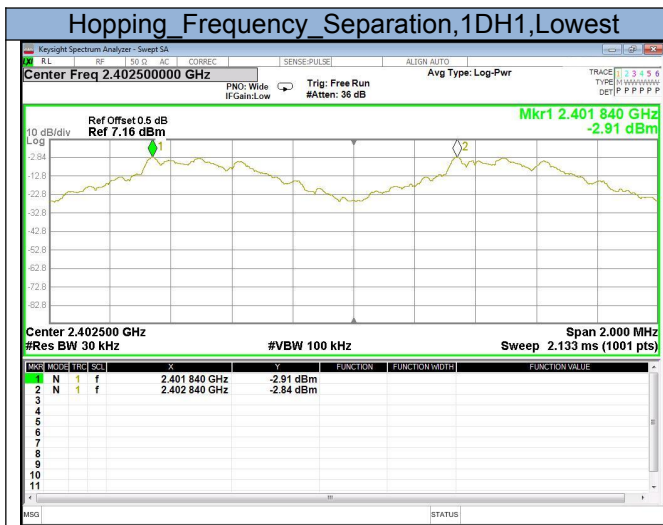

### Hopping Frequency Separation,2DH1,Middle



### Hopping Frequency Separation,2DH1,Highest

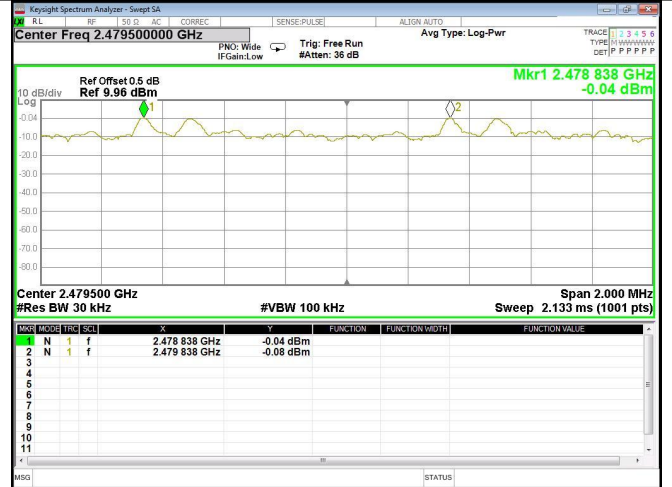

### Hopping Frequency Separation,3DH1,Lowest

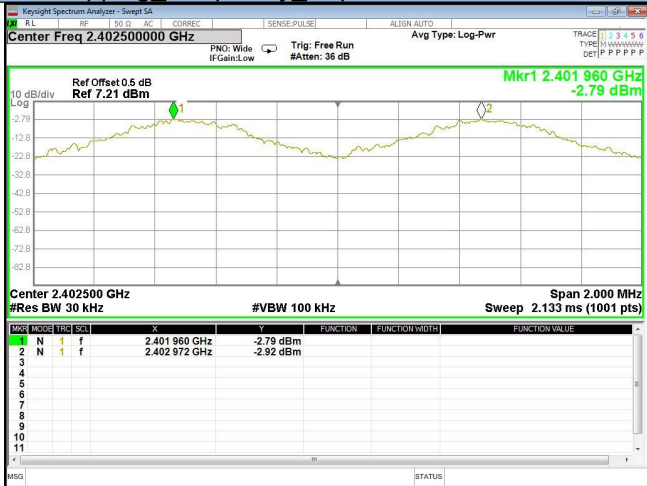

### Hopping Frequency Separation,3DH1,Middle

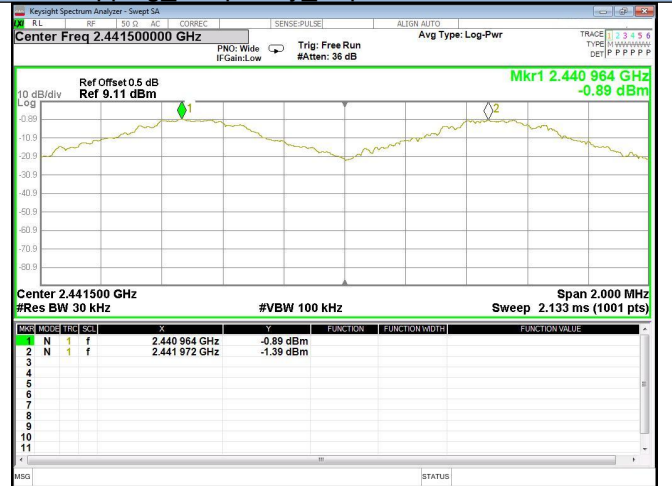

### Hopping Frequency Separation,3DH1,Highest

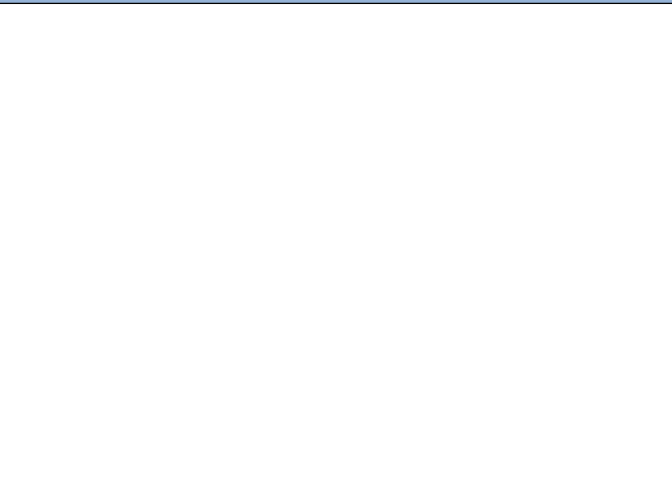
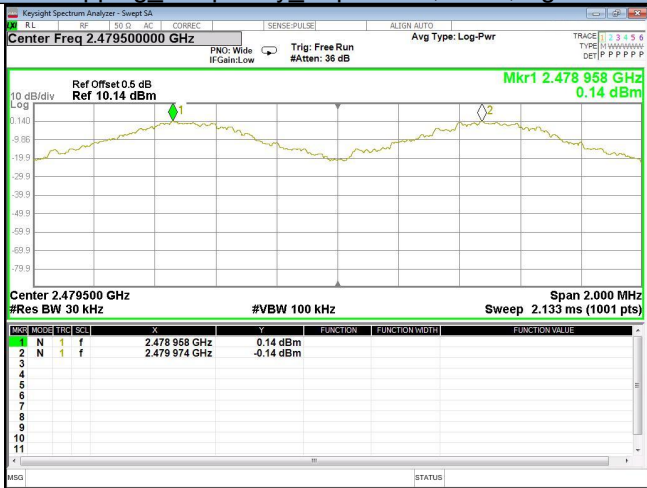

## 6. OCCUPIED CHANNEL BANDWIDTH

### 6.1 LIMIT

The Occupied Channel Bandwidth for each hopping frequency shall fall completely within the band given in table 1.

For non-adaptive Frequency Hopping equipment with e.i.r.p. greater than 10 dBm, the Occupied Channel Bandwidth for every occupied hopping frequency shall be equal to or less than the Nominal Channel Bandwidth declared by the manufacturer. See clause 5.4.1 j). This declared value shall not be greater than 5 MHz.

### 6.2 TEST PROCEDURES

1. Please refer to ETSI EN 300 328 (V2.1.1) clause 5.4.7.1 for the test conditions.
2. Please refer to ETSI EN 300 328 (V2.1.1) clause 5.4.7.2 for the measurement method.
  - Centre Frequency: The centre frequency of the channel under test
  - Resolution BW: ~ 1 % of the span without going below 1 %
  - Frequency Span for frequency hopping equipment: Lowest frequency separation that is used within the hopping sequence)
  - Frequency Span for other types of equipment:2 × Nominal Channel Bandwidth (e.g. 2 MHz for a 1 MHz channel)
  - Detector Mode: RMS
  - Trace Mode: Max Hold
  - Sweep time:1S

### 6.3 TEST SETUP

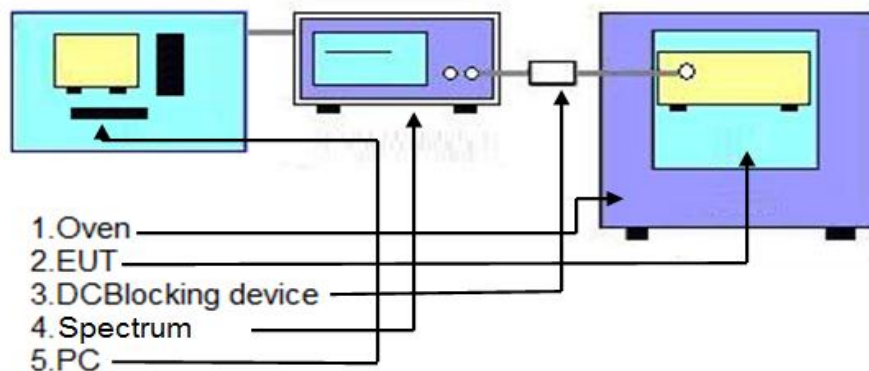



6.4 TEST RESULT

Occupied Channel Bandwidth								
Condition	Mode	Frequency(MHz)	OBW(MHz)	Lower Edge(MHz)	Upper Edge(MHz)	Limit Edge(MHz)	Results	Remark
NVNT	1DH1	2402	0.844	2401.575	-	2400-2483.5MHz	Pass	
NVNT	1DH1	2441	0.843	2440.574	-	2400-2483.5MHz	Pass	
NVNT	1DH1	2480	0.844	-	2480.418	2400-2483.5MHz	Pass	
NVNT	2DH1	2402	1.155	2401.407	-	2400-2483.5MHz	Pass	
NVNT	2DH1	2441	1.156	2440.405	-	2400-2483.5MHz	Pass	
NVNT	2DH1	2480	1.158	-	2480.561	2400-2483.5MHz	Pass	
NVNT	3DH1	2402	0.865	2401.560	-	2400-2483.5MHz	Pass	
NVNT	3DH1	2441	0.863	2440.560	2480.561	2400-2483.5MHz	Pass	
NVNT	3DH1	2480	0.865	-	2480.424	2400-2483.5MHz	Pass	

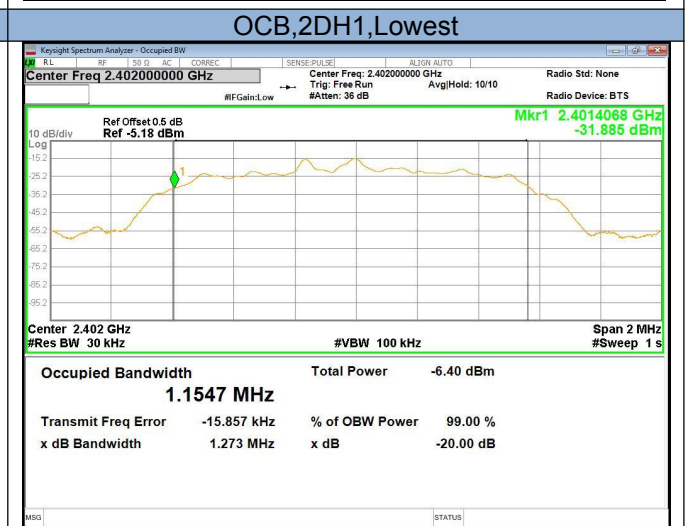
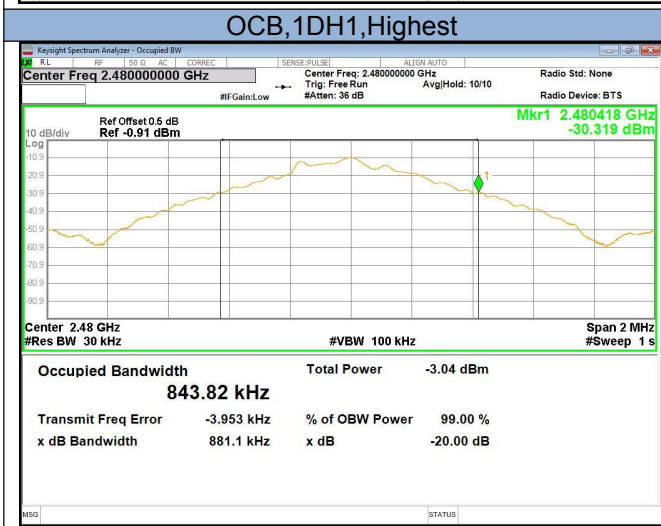
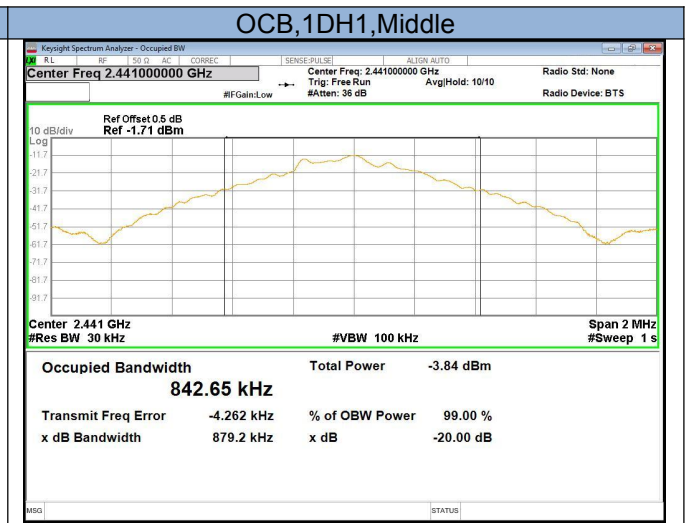
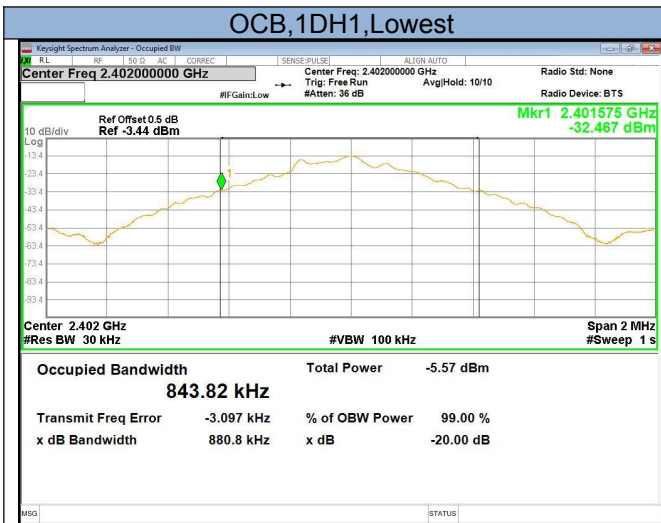





### OCB,2DH1,Middle

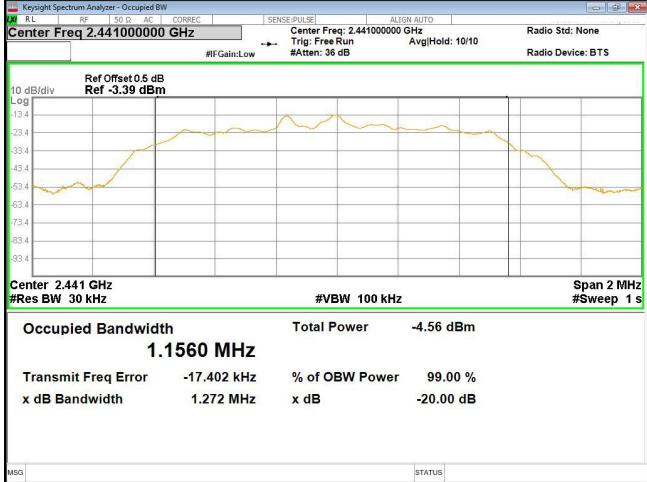

### OCB,2DH1,Highest

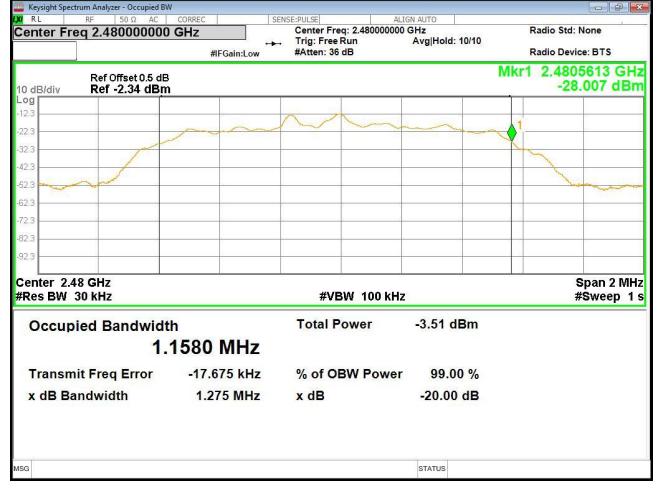

### OCB,3DH1,Lowest

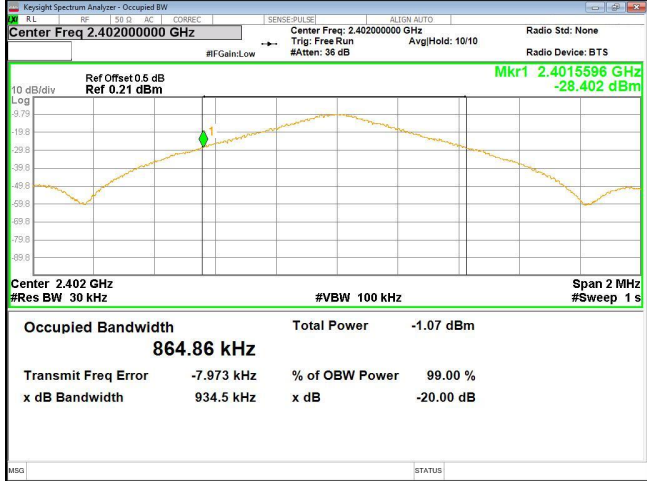

### OCB,3DH1,Middle

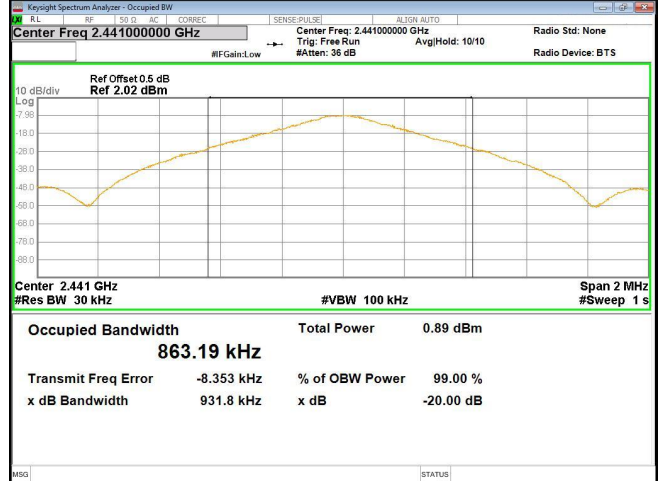

### OCB,3DH1,Highest

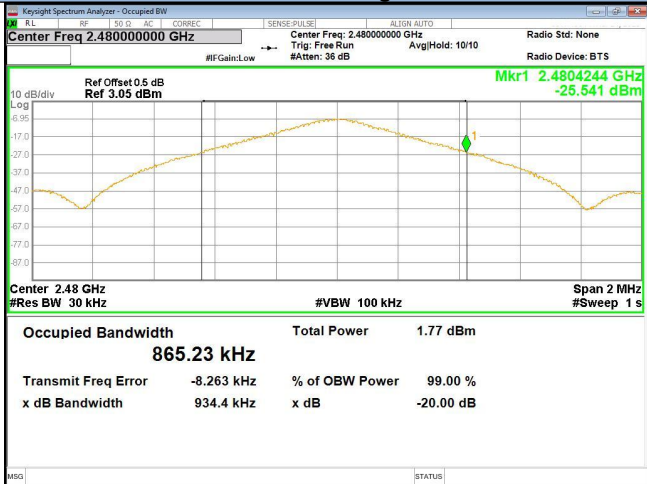

## 7. TRANSMITTER UNWANTED EMISSIONS IN THE OOB DOMAIN

### 7.1 LIMIT

Clause	Frequency	Limit
4.3.1.9.3	2400-BW~2400 2483.5~2483.5+BW	-10dBm/MHz
	2400-2BW~2400-BW 2483.5+BW~2483.5+2BW	-20dBm/MHz
	<2400-2BW >2483.5+2BW	-30dBm/MHz

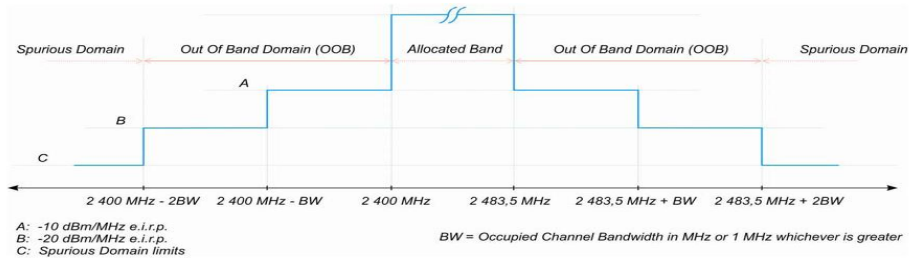

Figure 1: Transmit mask

### 7.2 TEST PROCEDURES

1. Please refer to ETSI EN 300 328 (V2.2.2) clause 5.4.8.1 for the test conditions.
2. Please refer to ETSI EN 300 328 (V2.2.2) clause 5.4.8.2 for the measurement method.

For systems using FHSS modulation, the measurements shall be performed during normal operation (hopping).

•Connect the UUT to the spectrum analyser and use the following settings:

- Centre Frequency: 2 484 MHz
- Span: 0 Hz
- Resolution BW: 1 MHz
- Filter mode: Channel filter
- Video BW: 3 MHz
- Detector Mode: RMS
- Trace Mode: Max Hold
- Sweep Mode: Continuous
- Sweep Points: Sweep Time [s] / (1 μs) or 5 000 whichever is greater
- Trigger Mode: Video trigger; in case video triggering is not possible, an external trigger source maybe used
- Sweep Time: > 120 % of the duration of the longest burst detected during the measurement of the RF Output Power

### 7.3 TEST SETUP

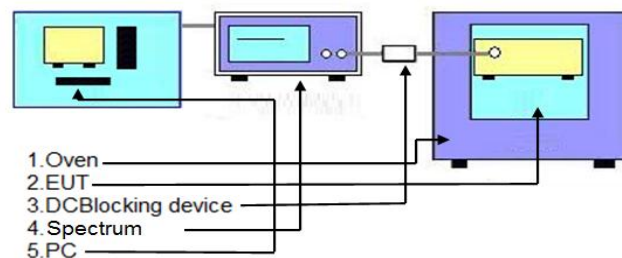





7.4 TEST RESULT

Transmitter_unwanted_emissions_in_the_OOB									
Condition	Mode	CF (MHz)	M F (MHz)	Level (dBm/MHz)	Segment A Limit(dBm/MHz)	M F(MHz)	Level(dBm /MHz)	Segment B Limit(dBm /MHz)	Results
NVNT	1DH1	2402	2399.500	-41.11	-10	2398.500	-42.61	-20	Pass
NVNT	1DH1	2480	2484.000	-42.82	-10	2485.000	-53.94	-20	Pass
NVNT	2DH1	2402	2399.345	-39.86	-10	2398.191	-45.72	-20	Pass
NVNT	2DH1	2402	2399.500	-40.80	-10	2398.345	-44.03	-20	Pass
NVNT	2DH1	2480	2484.000	-44.29	-10	2485.158	-53.89	-20	Pass
NVNT	2DH1	2480	2484.158	-45.53	-10	2485.316	-54.01	-20	Pass
NVNT	3DH1	2402	2399.500	-41.08	-10	2398.500	-41.97	-20	Pass
NVNT	3DH1	2480	2484.000	-43.04	-10	2485.000	-54.28	-20	Pass

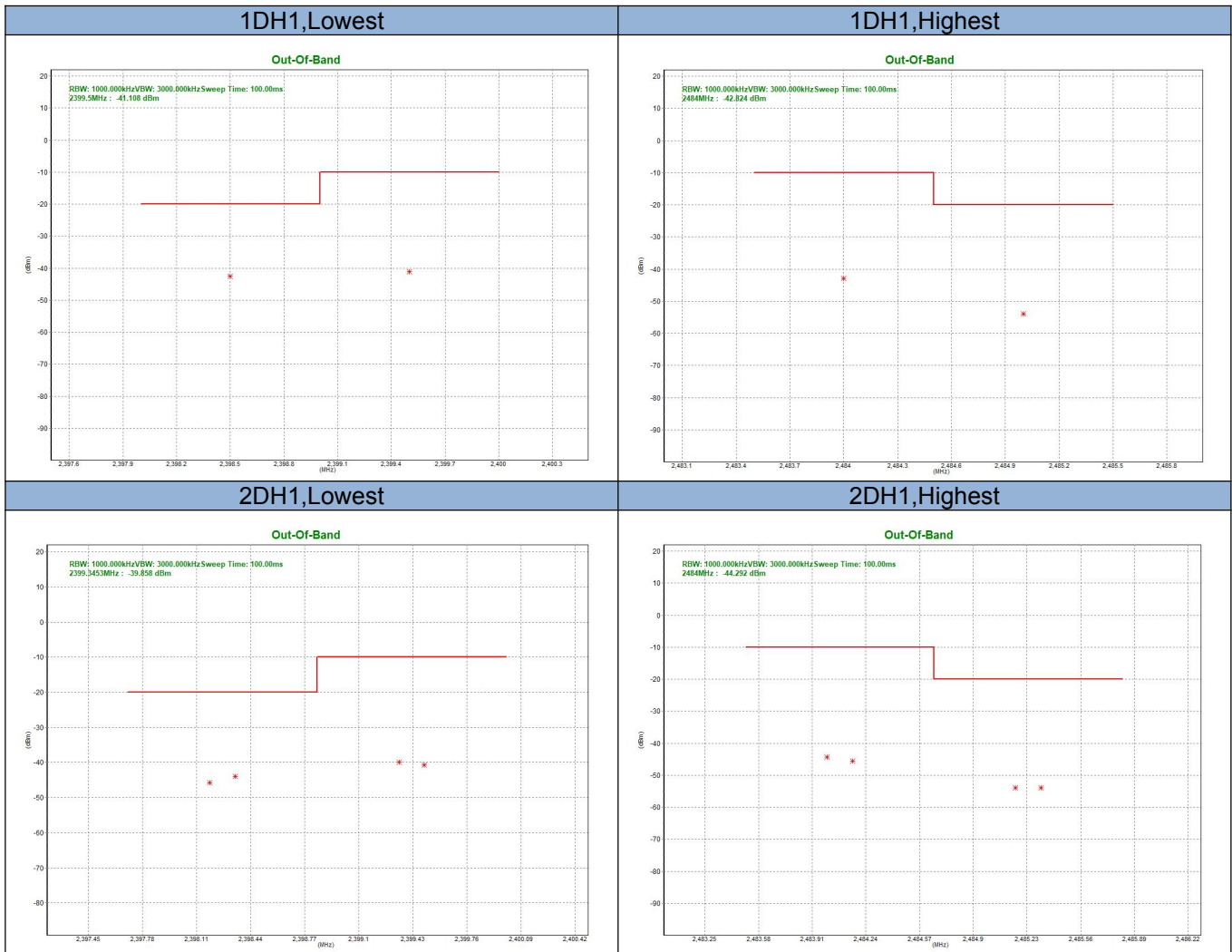

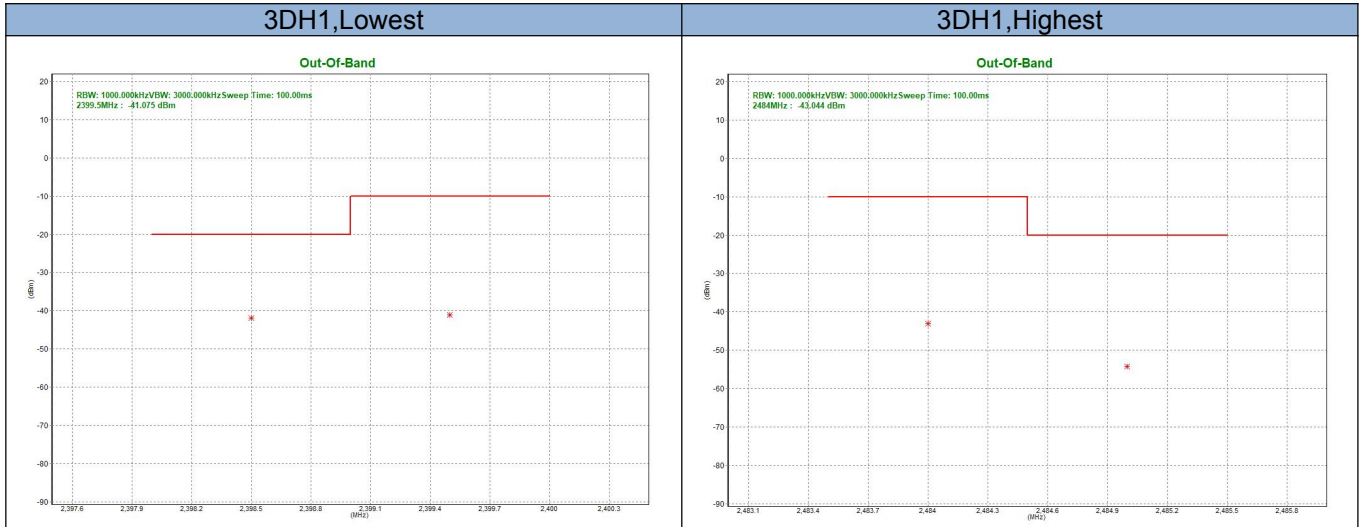

## 8. SPURIOUS EMISSIONS – TRANSMITTER

### 8.1 LIMIT

Frequency range	Maximum power, e.r.p( ≤1 GHz) e.i.r.p(> 1 GHz)	Bandwidth
30 MHz to 47 MHz	-36 dBm	100 KHz
47 MHz to 74 MHz	-54 dBm	100 KHz
74 MHz to 87.5 MHz	-36 dBm	100 KHz
87.5 MHz to 118 MHz	-54 dBm	100 KHz
118 MHz to 174 MHz	-36 dBm	100 KHz
174 MHz to 230 MHz	-54 dBm	100 KHz
230 MHz to 470 MHz	-36 dBm	100 KHz
470 MHz to 862 MHz	-54 dBm	100 KHz
862 MHz to 1 GHz	-36 dBm	100 KHz
1 GHz to 12.75 GHz	-30 dBm	1 MHz

### 8.2 TEST PROCEDURES

1. Please refer to ETSI EN 300 328 (V2.2.2) clause 5.4.9.1 for the test conditions.
2. Please refer to ETSI EN 300 328 (V2.2.2) clause 5.4.9.2 for the measurement method.

Spectrum Analyzer	Setting	
Frequency Start to Stop	30 MHz to 1000 MHz	1000 MHz to 12750MHz
Resolution bandwidth	100 kHz	1 MHz
Video bandwidth	300 kHz	3 MHz
Filter type	3 dB (Gaussian)	
Detector mode	Peak	
Trace Mode	Max Hold	
Sweep Points	≥ 19 400 (Set as 20000)	≥ 23 500 (Set as 24000)
Sweep Time	For non continuous transmissions (duty cycle less than 100 %), the sweep time shall be sufficiently long, Below 1GHz such that for each 100 kHz frequency step, Above 1GHz such that for each 1MHz frequency step the measurement time is greater than two transmissions of the UUT, on any channel	

- a. The EUT was placed on the top of the turntable in Semi Anechoic Room.
- b. The test shall be made in the transmitting mode. The turntable was rotated by 360 degrees to determine the position of the highest radiation.
- c. This measurement shall be repeated with the transmitter in standby mode where applicable.
- d. For 30~1000MHz spurious emissions measurement, the broad band bi-log receiving antenna was placed 3 meters far away from the turntable.
- e. The broadband receiving antenna was fixed on the same height with the EUT to find each suspected emissions of both horizontal and vertical polarization. Each recorded suspected value is indicated as Read Level (Raw).
- f. Replace the EUT by standard antenna and feed the RF port by signal generator.
- g. Adjust the frequency of the signal generator to the suspected emission and slightly rotate the turntable to locate the position with maximum reading.
- h. Adjust the power level of the signal generator to reach the same reading with Read Level (Raw).
- i. The level of the spurious emission is the power level of (8) plus the gain of the standard antenna in dBi and minus the loss of the cable used between the signal generator and the standard antenna.
- j. If the level calculated in (9) is higher than limit by more than 6dB, then lower the RBW of the spectrum analyzer to 30KHz. If the level of this emission does not change by more than 2dB, then it is taken as narrowband emission, otherwise, wideband emission.
- k. The measurement shall be repeated at the lowest and the highest channel of the stated frequency range.
- l. EUT Orthogonal Axis:  
 "X" - denotes Laid on Table; "Y" - denotes Vertical Stand; "Z" - denotes Side Stand.

### 8.3 TEST SETUP

(A) Radiated Emission Test Set-Up, Frequency Below 1000MHz

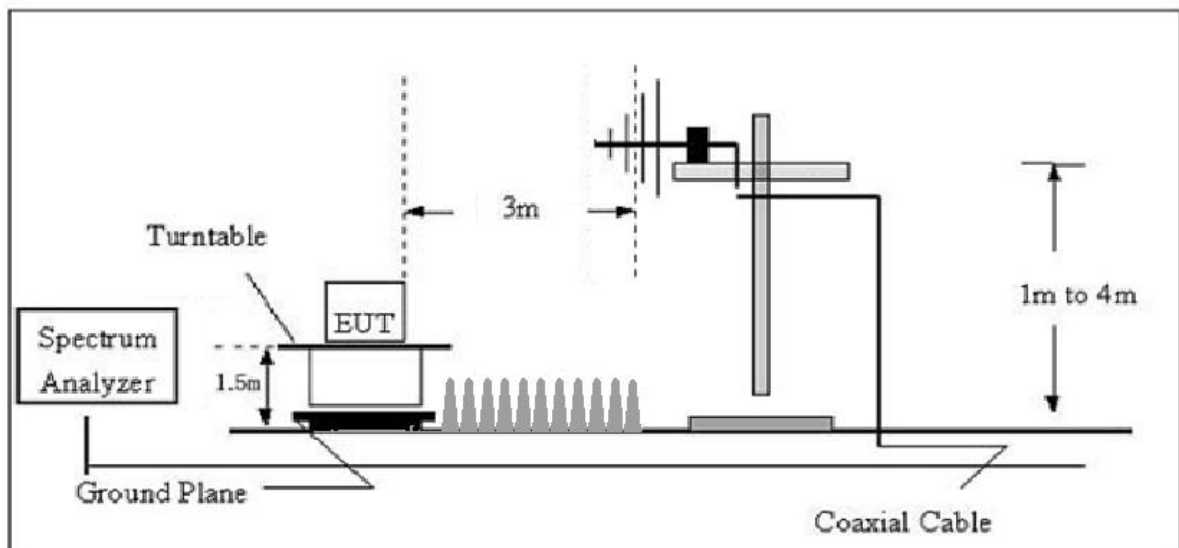

(B) Radiated Emission Test Set-Up Frequency Above 1 GHz

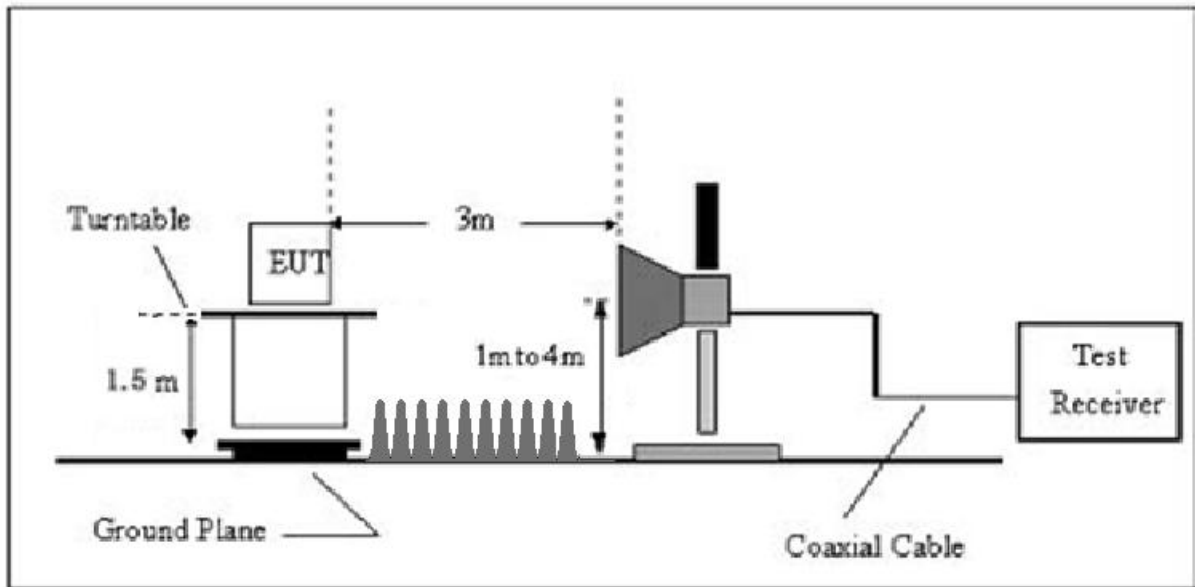

8.4 EUT OPERATION DURING TEST

1. The EUT was programmed to be in continuous transmitting mode.
2. For the initial investigation on the highest, lowest frequency, no significant differences in spurious emissions were observed between these 2 channels. The worst test data was shown
3. There is a filter used during the test, the fundamental signals will be not shown in the plot.
4. The EUT is connected with the GSM base station when the BT is transmitting.



### 8.5 TEST RESULT

Remark: The all data rate modes had been test, but only worse test data was recorded in the test report.

TX 8DPSK/2402MHz

30MHz-1GHz

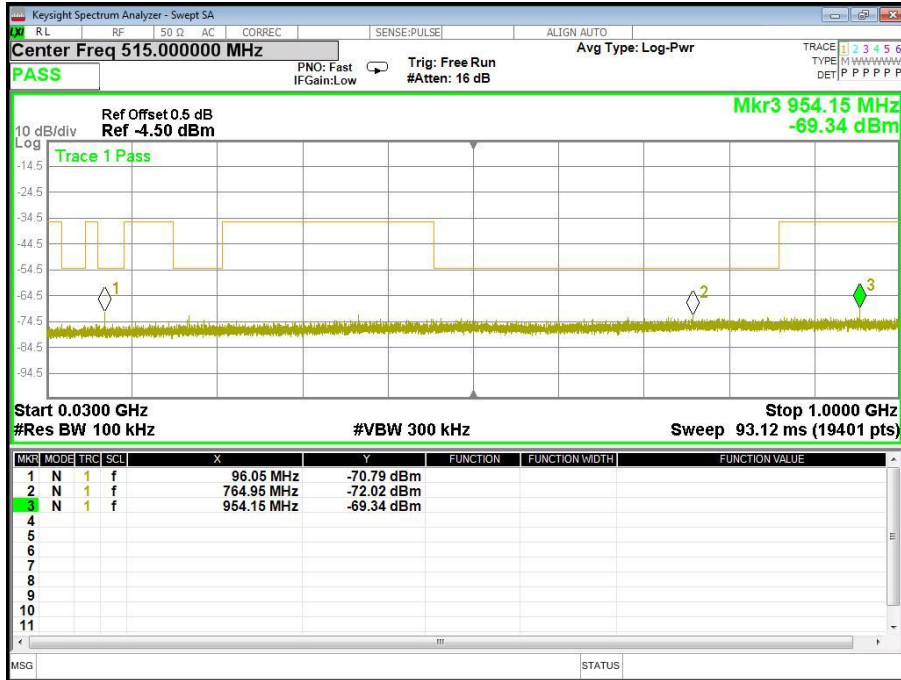

1GHz-12.75GHz





TX 8DPSK/2480MHz  
30MHz-1GHz



1GHz-12.75GHz

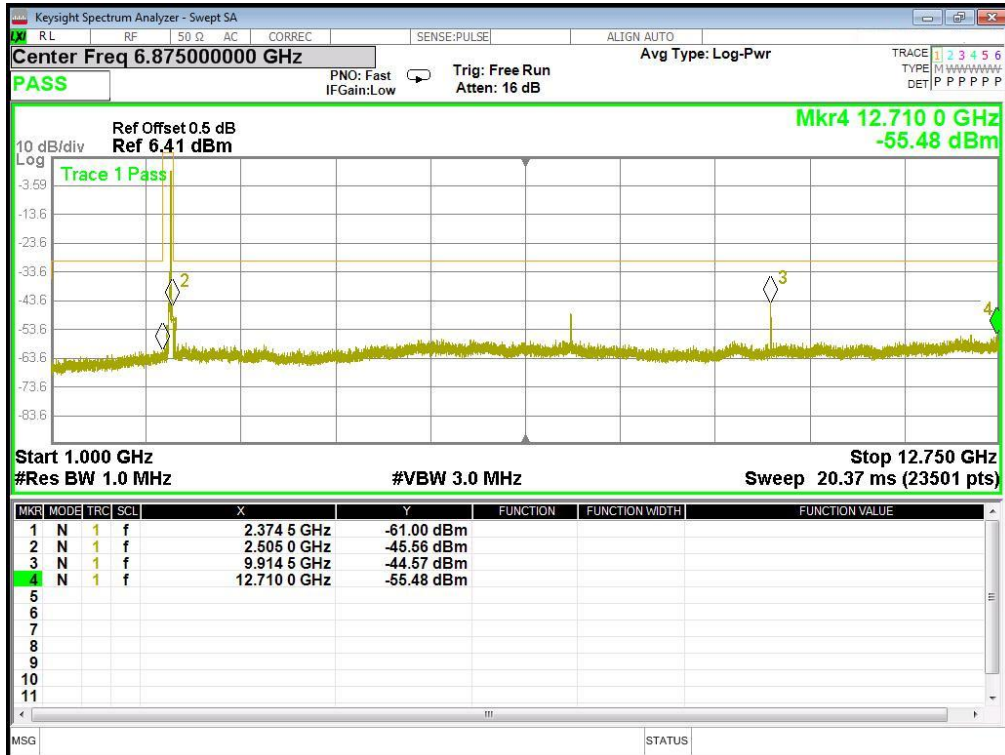



## 9. SPURIOUS EMISSIONS – RECEIVER

### 9.1 LIMIT

Clause	Test Item	Frequency(MHz)	Limit
4.3.1.11.3	Spurious emissions	30-1000	-57dBm
	(radiated)	1000-12750	-47dBm

### 9.2 TEST PROCEDURES

1. Please refer to ETSI EN 300 328 (V2.2.2) clause 5.4.10.1 for the test conditions.
2. Please refer to ETSI EN 300 328 (V2.2.2) clause 5.4.10.2 for the measurement method.

Spectrum Analyzer	Setting	
Frequency Start to Stop	30 MHz to 1000 MHz	1000 MHz to 12750MHz
Resolution bandwidth	100 kHz	1 MHz
Video bandwidth	300 kHz	3 MHz
Filter type	3 dB (Gaussian)	
Detector mode	Peak	
Trace Mode	Max Hold	
Sweep Points	≥ 19 400 (Set as 20000)	≥ 23 500 (Set as 24000)
Sweep Time	For non continuous transmissions (duty cycle less than 100 %), the sweep time shall be sufficiently long, Below 1GHz such that for each 100 kHz frequency step, Above 1GHz such that for each 1MHz frequency step the measurement time is greater than two transmissions of the UUT, on any channel	

- a. The EUT was placed on the top of the turntable in Semi Anechoic Room.
- b. The test shall be made in the receiving mode. The turntable was rotated by 360 degrees to determine the position of the highest radiation.
- c. For 30~1000MHz/1000~12750MHz spurious emissions measurement, the broad band bi-log receiving antenna was placed 3 meters far away from the turntable.  
The broadband receiving antenna was fixed on the same height with the EUT to find each
- d. suspected emissions of both horizontal and vertical polarization. Each recorded suspected value is indicated as Read Level (Raw).
- e. Replace the EUT by standard antenna and feed the RF port by signal generator.
- f. Adjust the frequency of the signal generator to the suspected emission and slightly rotate the turntable to locate the position with maximum reading.
- g. Adjust the power level of the signal generator to reach the same reading with Read Level (Raw).
- h. The level of the spurious emission is the power level of (7) plus the gain of the standard antenna in dBi and minus the loss of the cable used between the signal generator and the standard antenna.
- i. The measurement shall be repeated at the lowest and the highest channel of the stated frequency range.
- j. EUT Orthogonal Axis:©



### 9.3 EUT OPERATION DURING TEST

The EUT was programmed to be in continuously receiving mode.

### 9.4 TEST SETUP

(A) Radiated Emission Test Set-Up, Frequency Below 1000MHz

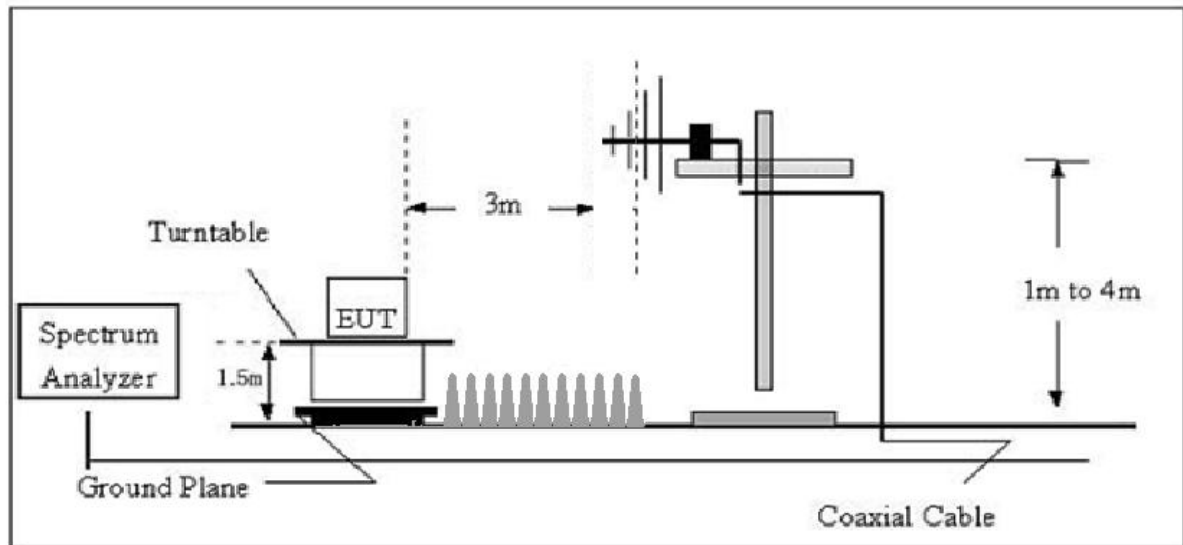

(B) Radiated Emission Test Set-Up Frequency Above 1 GHz

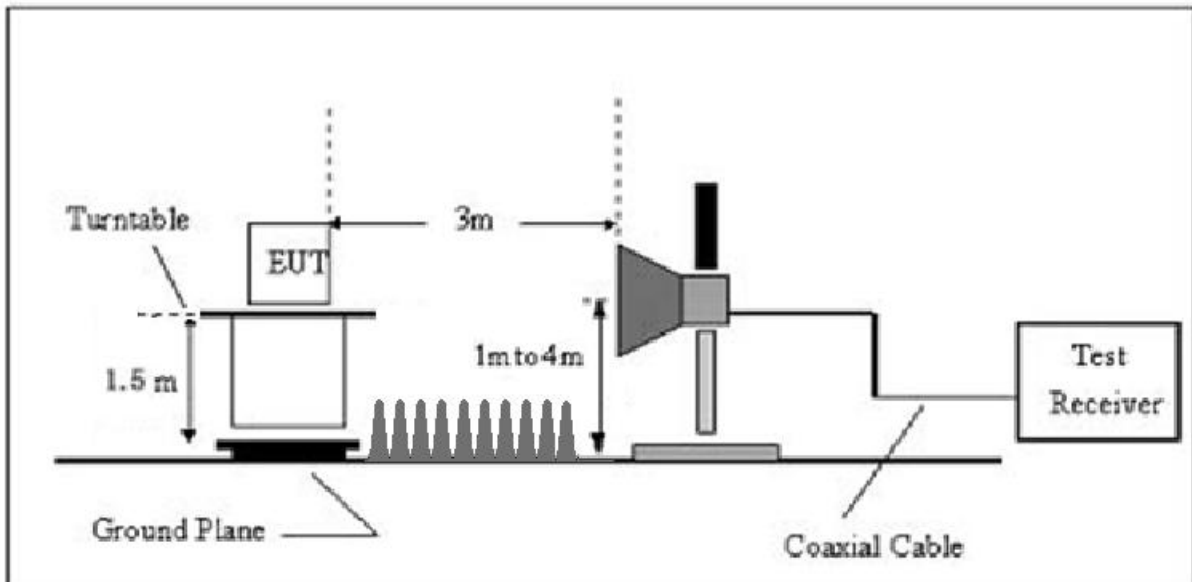

### 9.5 TEST RESULT

Remark: The all data rate modes had been test, but only worse test data was recorded in the test report.

#### RX

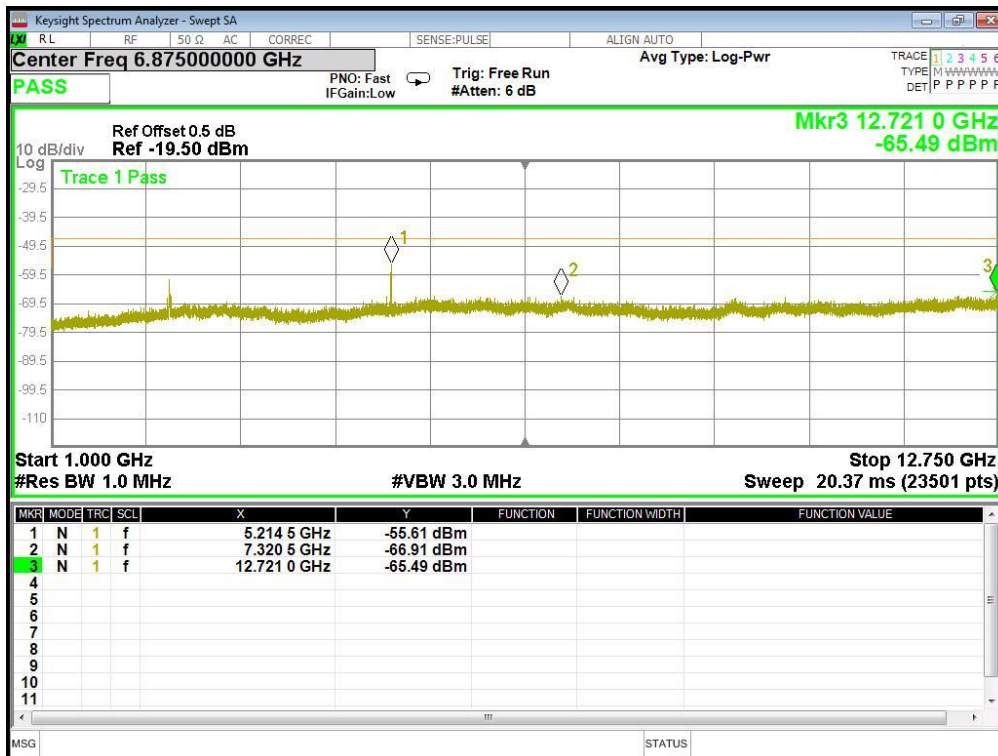

## 10. RECEIVER BLOCKING

### 10.1 LIMIT

While maintaining the minimum performance criteria as defined in clause 4.3.1.12.3, the blocking levels at specified frequency offsets shall be equal to or greater than the limits defined for the applicable receiver category provided in table 6, table 7 or table 8.

#### Receiver Category 1

Table 6: Receiver Blocking parameters for Receiver Category 1 equipment

Wanted signal mean power from companion device (dBm)	Blocking signal frequency (MHz)	Blocking signal power (dBm)	Type of blocking Signal
Pmin + 6 dB	2 380 2 503,5	-53	CW
Pmin + 6 dB	2 300 2 330 2 360	-47	CW
Pmin + 6 dB	2 523,5 2 553,5 2 583,5 2 613,5 2 643,5 2 673,5	-47	CW

NOTE 1: Pmin is the minimum level of the wanted signal (in dBm) required to meet the minimum performance criteria as defined in clause 4.3.2.11.3 in the absence of any blocking signal.

NOTE 2: The levels specified are levels in front of the UUT antenna. In case of conducted measurements, the levels have to be corrected by the actual antenna assembly gain.

#### Receiver Category 2

Table 7: Receiver Blocking parameters for Receiver Category 2 equipment

Wanted signal mean power from companion device (dBm)	Blocking signal frequency (MHz)	Blocking signal power (dBm)	Type of blocking Signal
Pmin + 6 dB	2 380 2 503,5	-57	CW
Pmin + 6 dB	2 300 2 583,5	-47	CW

NOTE 1: Pmin is the minimum level of the wanted signal (in dBm) required to meet the minimum performance criteria as defined in clause 4.3.2.11.3 in the absence of any blocking signal.

NOTE 2: The levels specified are levels in front of the UUT antenna. In case of conducted measurements, the levels have to be corrected by the actual antenna assembly gain.

**Receiver Category 3**

Table 8: Receiver Blocking parameters for Receiver Category 3 equipment

Wanted signal mean power from companion device (dBm)	Blocking signal frequency (MHz)	Blocking signal power (dBm)	Type of blocking Signal
Pmin + 12 dB	2 380 2 503,5	-57	CW
Pmin + 12 dB	2 300 2 583,5	-47	CW

NOTE 1: Pmin is the minimum level of the wanted signal (in dBm) required to meet the minimum performance criteria as defined in clause 4.3.2.11.3 in the absence of any blocking signal.  
 NOTE 2: The levels specified are levels in front of the UUT antenna. In case of conducted measurements, the levels have to be corrected by the actual antenna assembly gain.

**10.2 TEST PROCEDURES**

1. Please refer to ETSI EN 300 328 (V2.2.2) clause 5.4.11.1 for the test conditions.
2. Please refer to ETSI EN 300 328 (V2.2.2) clause 5.4.11.2 for the measurement method.
  - RBW: use next available RBW setting below the measured Occupied Channel Bandwidth (Occupied Channel Bandwidth)
  - Filter type: Channel Filter
  - VBW: > RBW
  - RBW:1M
  - VBW:3M (Max 2M)
  - Detector Mode: RMS
  - Centre Frequency: Equal to the hopping frequency to be tested
  - Span: 0 Hz
  - Sweep time: > Channel Occupancy Time of the UUT. If the Channel Occupancy Time is non-contiguous (non-LBT based equipment), the sweep time shall be sufficient to cover the period over which the Channel Occupancy Time is spread out.
  - Trace Mode: Clear/Write
  - Trigger Mode: Video

### 10.3 TEST SETUP

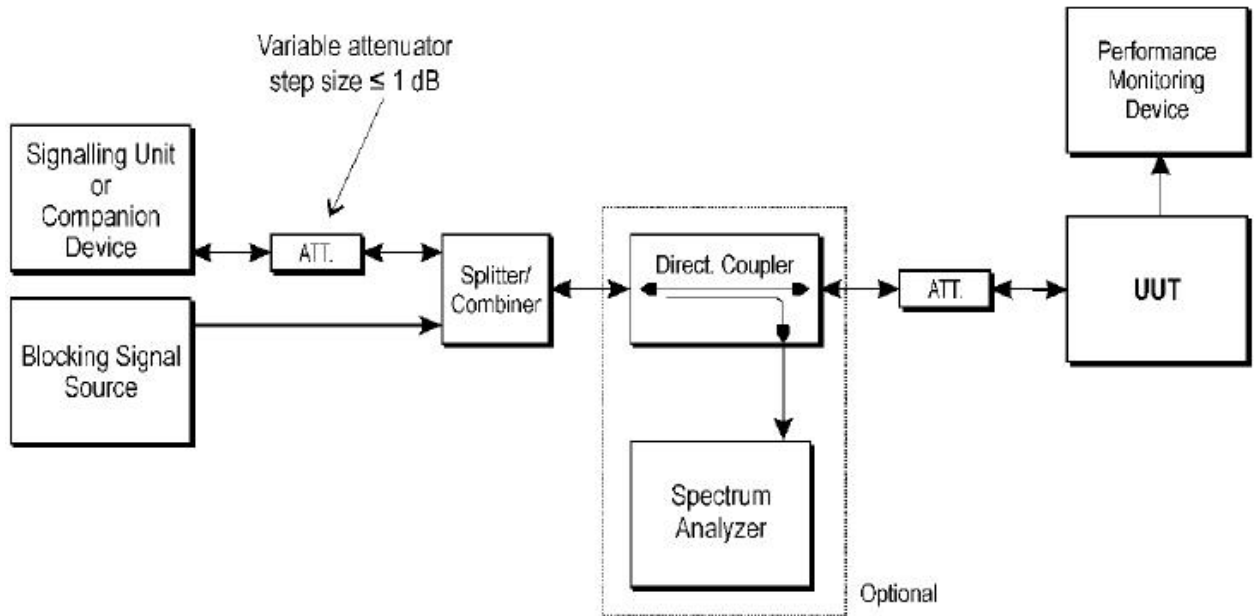

10.4 TEST RESULT

Note: The power more than 0dBm, less than 10dBm, belong to category 2.

GFSK Hopping Worst

Wanted signal mean power from companion device (dBm)	Blocking signal frequency (MHz)	Blocking signal power(dBm) CW	PER	Limit	Results
-65	2 380	-57	0.28%	≤10%	PASS
	2 503,5		0.35%		
	2 300	-47	0.18%		
	2 583,5		0.64%		

NOTE:

(1)The minimum performance criterion shall be a PER less than or equal to 10 %. The manufacturer may declare alternative performance criteria as long as that is appropriate for the intended use of the equipment (see clause 5.4.1.t).

(2) Pmin=-71dBm

π/4-DQPSK Hopping Worst

Wanted signal mean power from companion device (dBm)	Blocking signal frequency (MHz)	Blocking signal power(dBm) CW	PER	Limit	Results
-65	2 380	-57	0.40%	≤10%	PASS
	2 503,5		0.56%		
	2 300	-47	0.15%		
	2 583,5		0.21%		

NOTE:

(1)The minimum performance criterion shall be a PER less than or equal to 10 %. The manufacturer may declare alternative performance criteria as long as that is appropriate for the intended use of the equipment (see clause 5.4.1.t).

(2) Pmin=-71dBm



## 8DPSK Hopping Worst

Wanted signal mean power from companion device (dBm)	Blocking signal frequency (MHz)	Blocking signal power(dBm) CW	PER	Limit	Results
-65	2 380	-57	0.19%	≤10%	PASS
	2 503,5		0.51%		
	2 300	-47	0.18%		
	2 583,5		0.24%		

## NOTE:

(1)The minimum performance criterion shall be a PER less than or equal to 10 %. The manufacturer may declare alternative performance criteria as long as that is appropriate for the intended use of the equipment (see clause 5.4.1.t).

(2) Pmin=-71dBm

## 11. ADAPTIVE (CHANNEL ACCESS MECHANISM)

### 11.1 LIMIT

The frequency range of the equipment is determined by the lowest and highest

Adaptive Frequency Hopping using LBT based DAA:

1. COT ≤ 60 ms;
2. Idle Period = 5% of COT;
3. Detection threshold level =  $-70 \text{ dBm/MHz} + (20 \text{ dBm} - \text{Pout e.i.r.p.})/1 \text{ MHz}$  (Pout in dBm).

Adaptive Frequency Hopping using other forms of DAA (non-LBT based):

1. The frequency shall remain unavailable for a minimum time equal to 1 second or 5 times the actual number of hopping frequencies in the current (adapted) channel map used by the equipment
2. COT ≤ 40ms;
3. Idle Period = 5% of COT;
4. Detection threshold level =  $-70 \text{ dBm/MHz} + (20 \text{ dBm} - \text{Pout e.i.r.p.})/1 \text{ MHz}$  (Pout in dBm).

Short Control Signalling Transmissions:

Short Control Signalling Transmissions shall have a maximum duty cycle TxOn / (TxOn + TxOff) ratio of 10 % within any observation period of 50 ms.

### 11.2 TEST PROCEDURES

1. Please refer to ETSI EN 300 328 (V2.2.2) clause 5.4.6.1 for the test conditions.
2. Please refer to ETSI EN 300 328 (V2.2.2) clause 5.4.6.2 for the measurement method.
3. The spectrum analyzer sweep was triggered by the start of the interfering signal, with the interfering signal present, a 100 % duty cycle CW signal is inserted as the blocking signal.
  - RBW: ≥ Occupied Channel Bandwidth (if the analyzer does not support this setting, the highest available setting shall be used)
  - RBW: use next available RBW setting below the measured Occupied Channel Bandwidth
  - Filter type: Channel Filter
  - RBW: 1M/VBW: 3M
  - Detector Mode: RMS
  - Centre Frequency: Equal to the hopping frequency to be tested.
  - Span: 0 Hz
  - Sweep time: > Channel Occupancy Time of the UUT. If the Channel Occupancy Time is non-contiguous (non-LBT based equipment), the sweep time shall be sufficient to cover the period over which the Channel Occupancy Time is spread out
  - Trace Mode: Clear/Write
  - Trigger Mode: Video



### 11.3 TEST SETUP

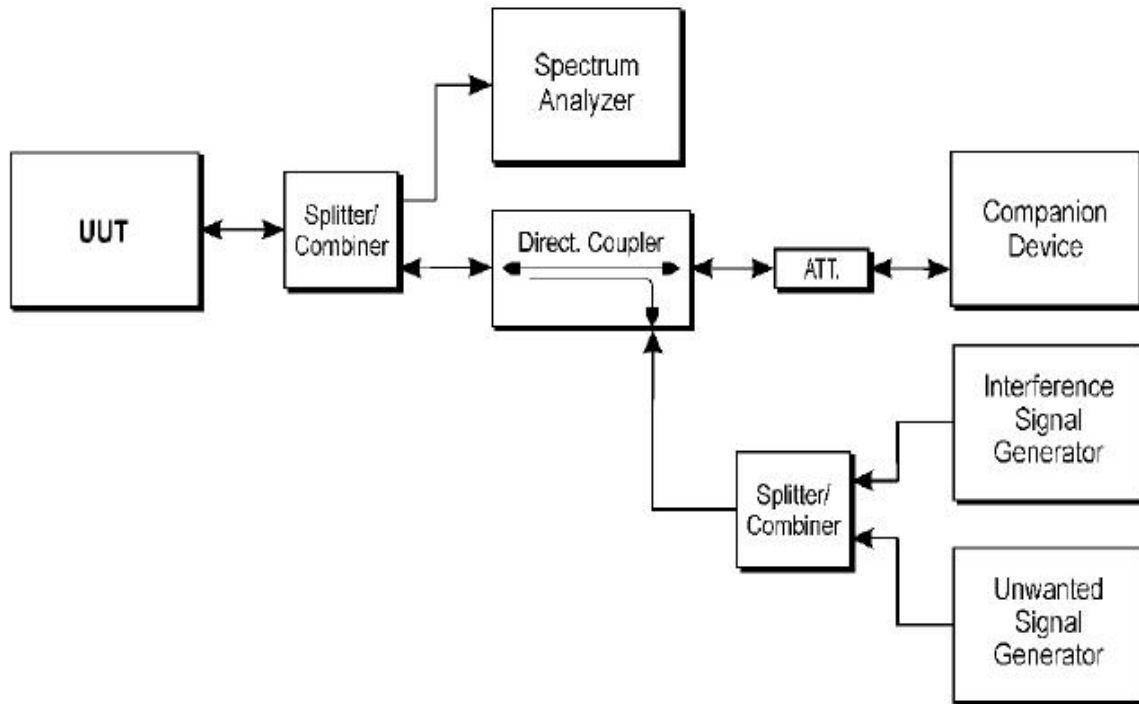

- a. BT is normal transmission
- b. interference shall be injected ->BT shall stop transmission.
- c. blocking shall be injected ->BT does not resume any normal transmission
- d. Removing the interference and blocking signal

### 11.4 TEST RESULTS

Note: The power less than 10dBm, not apply.

\*\*\*\*\*END OF THE REPORT\*\*\*\*\*



# TEST REPORT

Report No: FCS202312148H01

Issued for

Applicant::	Mid Ocean Brands B.V.
Address:	7/F, Kings Tower, 111 King Lam Street, Cheung Sha Wan, Kowloon, Hong Kong.
Product Name:	Wireless speaker
Brand Name:	N/A
Model Name:	MO2210
Series Model:	N/A
Test Standard:	EN 62479: 2010

**TEST RESULT CERTIFICATION**

Applicant's Name.....: Mid Ocean Brands B.V.  
Address.....: 7/F, Kings Tower, 111 King Lam Street, Cheung Sha Wan,  
Kowloon, Hong Kong.  
Manufacture's Name.....: Mid Ocean Brands B.V.  
Address.....: 7/F, Kings Tower, 111 King Lam Street, Cheung Sha Wan,  
Kowloon, Hong Kong.

**Product Description**

Product Name.....: Wireless speaker  
Brand Name .....: N/A  
Model Name.....: MO2210  
Series Model.....: N/A  
Test Standards.....: EN 62479: 2010

This device described above has been tested by FCS, and the test results show that the equipment under test (EUT) is in compliance with the 2014/53/EU RED Directive requirements. And it is applicable only to the tested sample identified in the report.

This report shall not be reproduced except in full, without the written approval of FCS, this document may be altered or revised by FCS, personal only, and shall be noted in the revision of the document.

**Date of Test**.....:

Date (s) of performance of tests.: Dec 10, 2023 ~ Dec 15,2023

Date of Issue.....: Dec 15,2023

Test Result.....: Pass

Testing Engineer :



(Sam Wang)

Technical Manager :



(Duke Qian)

Authorized Signatory :

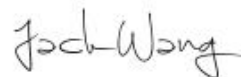

(Jack Wang)





## TABLE OF CONTENT

Description	Page
<b>1. GENERAL INFORMATION.....</b>	<b>4</b>
<b>1.1 Assess Standard.....</b>	<b>4</b>
<b>1.2 Assess Laboratory.....</b>	<b>4</b>
<b>2. CONFORMITY ASSESSMENT METHODS.....</b>	<b>4</b>
<b>3. ASSESS RESULT.....</b>	<b>6</b>

## 1. GENERAL INFORMATION

### 1.1 Assess Standard

EN 62479:2010: Assessment of electronic and electrical equipment related to human exposure restrictions for electromagnetic fields (10 MHz – 300 GHz)

### 1.2 Assess Laboratory

Company Name:	Dongguan Funas Testing Technology Co., Ltd.
Address:	Room 105, 1/F.. Baohao Technology Building 1, No.15, Gongye West Road.Songshan Lake Hi-Tech Industrial Area, Dongguan, Guangdong, China
Telephone:	+86-769-27280901
Fax:	+86-769-27280901
Laboray Accreditations	
FCC Test Firm Registration Number: 514908	
CNAS Number: L15566	
Designation number: CN0127	
A2LA accreditation number: 5545.01	
ISED Number: 25801	

## 2. CONFORMITY ASSESSMENT METHODS

#### General considerations

Compliance of electromagnetic emissions from electronic and electrical equipment with the basic restrictions usually is determined by measurements and, in some cases, calculation of the exposure level. If the electrical power used by or radiated by the equipment is sufficiently low, the electromagnetic fields emitted will be incapable of producing exposures that exceed the basic restrictions.

Four routes, as illustrated in Figure 1 and described as follows, can be used to demonstrate compliance with EN 62479

1. Typical usage, installation and the physical characteristics of equipment make it inherently compliant with the applicable EMF exposure levels such as those listed in the bibliography. This low-power equipment includes unintentional (or non-intentional) radiators, for example incandescent light bulbs and audio/visual (A/V) equipment, information technology equipment (ITE) and multimedia equipment (MME) that does not contain radio transmitters.

2. The input power level to electrical or electronic components that are capable of radiating electromagnetic energy in the relevant frequency range is so low that the available antenna power and/or the average total radiated power cannot exceed the low-power exclusion level defined in 4.2 of EN 62479

3. The available antenna power and/or the average total radiated power are limited by product standards for transmitters to levels below the low-power exclusion level defined in 4.2 of EN 62479
4. Measurements or calculations show that the available antenna power and/or the average total radiated power are below the low-power exclusion level defined in 4.2 of EN 62479

If none of these routes can be used, then the equipment is deemed to be out of the scope of this standard and EMF assessment for conformity assessment purposes shall be made according to other standards, such as IEC 62479 or other EMF product standards

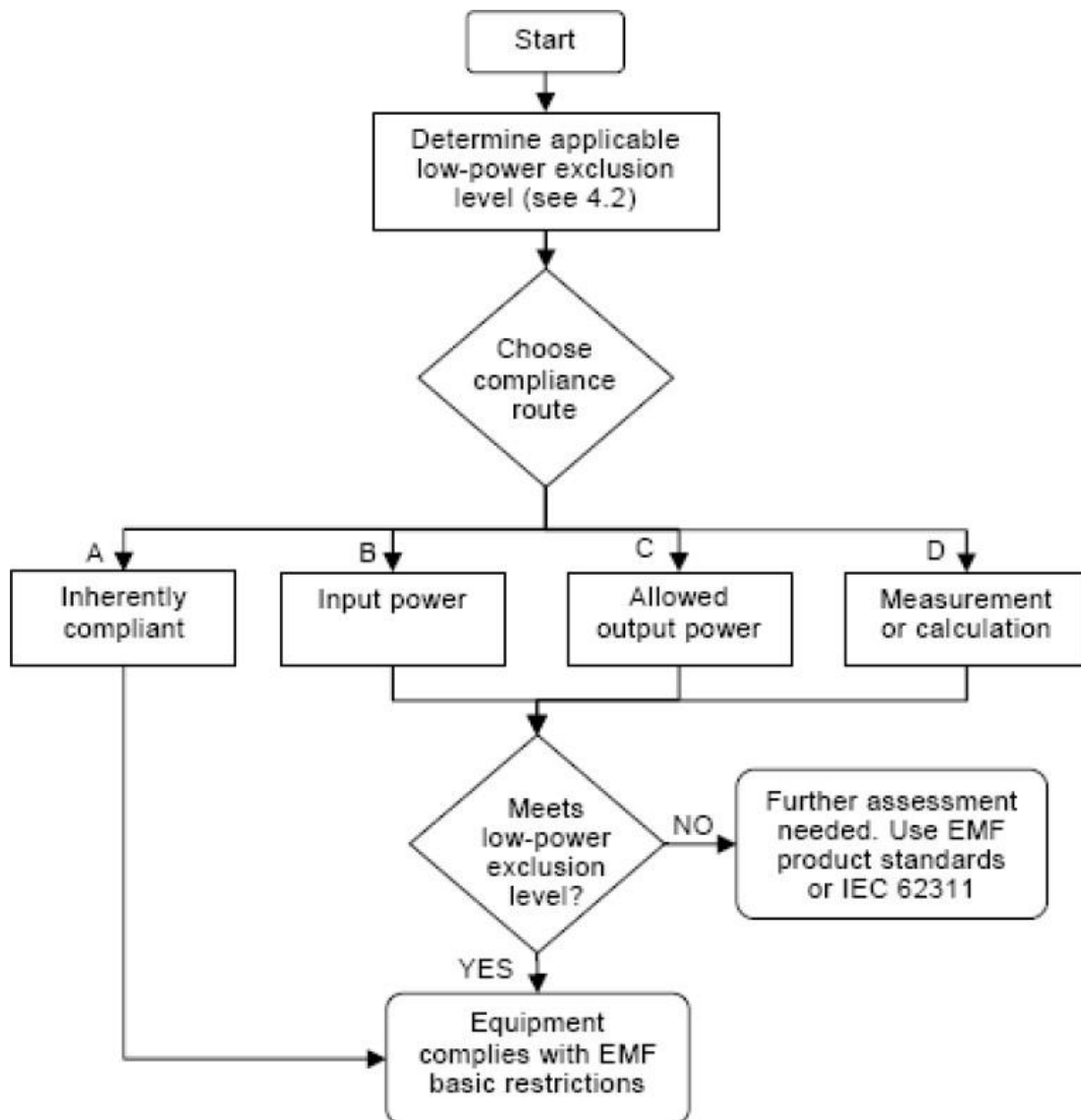

#### Low-power exclusion level (Pmax)

Low-power electronic and electrical equipment is deemed to comply with the provisions of EN 62479 if it can be demonstrated using routes B, C or D that the available antenna power and/or the average total radiated power is less than or equal to the applicable low-power exclusion level Pmax

For wireless devices operated close to a person's body with available antenna powers and/or average total radiated powers higher than the Pmax values given in Annex A of EN 62479 the alternative Pmax values (called Pmax'), described in Annex B of EN 62479 can also be used.

### 3. ASSESS RESULT

1.It is found that the max result is 3.39dBm (2.18272 mW) less than 20 mW (please refer to the test report "FCS202312148W01". The SAR-based Pmax follows Guideline / Standard: ICNIRP. Therefore, the EUT is deemed to comply with EMF basic restrictions