



中国认可
国际互认
检测
TESTING
CNAS L4062



TEST REPORT

Reference No..... : WTF23X10227453W001
 Manufacturer : Mid Ocean Brands B.V.
 Address : 7/F., Kings Tower, 111 King Lam Street, Cheung Sha Wan, Kowloon, Hong Kong
 Factory : 118144
 Product Name : ABS TWS earbuds
 Model No..... : MO2206
 Standards : ETSI EN 300 328 V2.2.2 (2019-07)
 Date of Receipt sample : 2023-10-24
 Date of Test..... : 2023-10-24 to 2023-11-05
 Date of Issue : 2023-11-05
 Test Report Form No. : WTX_ ETSI EN 300 328_2019W
 Test Result..... : Pass

Remarks:

The results shown in this test report refer only to the sample(s) tested, this test report cannot be reproduced, except in full, without prior written permission of the company. The report would be invalid without specific stamp of test institute and the signatures of approver.

Prepared By:

Waltek Testing Group (Shenzhen) Co., Ltd.

Address: 1/F., Room 101, Building 1, Hongwei Industrial Park, Liuxian 2nd Road,
 Block 70 Bao'an District, Shenzhen, Guangdong, China
 Tel.: +86-755-33663308 Fax.: +86-755-33663309 Email: sem@waltek.com.cn

Tested by:

Gala Wang

Approved by:

Silin Chen



TABLE OF CONTENTS

| | |
|---|-----------|
| 1. GENERAL INFORMATION..... | 4 |
| 1.1 PRODUCT DESCRIPTION FOR EQUIPMENT UNDER TEST (EUT)..... | 4 |
| 1.2 TEST STANDARDS..... | 6 |
| 1.3 TEST METHODOLOGY..... | 6 |
| 1.4 TEST FACILITY..... | 6 |
| 1.5 EUT SETUP AND TEST MODE..... | 7 |
| 1.6 MEASUREMENT UNCERTAINTY..... | 8 |
| 1.7 TEST EQUIPMENT LIST AND DETAILS..... | 9 |
| 2. SUMMARY OF TEST RESULTS..... | 11 |
| 3. RF OUTPUT POWER..... | 12 |
| 3.1 STANDARD APPLICABLE..... | 12 |
| 3.2 TEST PROCEDURE..... | 12 |
| 3.3 SUMMARY OF TEST RESULTS..... | 13 |
| 4. ACCUMULATED TRANSMIT TIME, FREQUENCY OCCUPATION AND HOPPING SEQUENCE..... | 16 |
| 4.1 STANDARD APPLICATION..... | 16 |
| 4.2 TEST PROCEDURE..... | 16 |
| 4.3 SUMMARY OF TEST RESULTS/PLOTS..... | 18 |
| 5. HOPPING FREQUENCY SEPARATION..... | 19 |
| 5.1 STANDARD APPLICATION..... | 19 |
| 5.2 TEST PROCEDURE..... | 19 |
| 5.3 SUMMARY OF TEST RESULTS/PLOTS..... | 20 |
| 6. OCCUPIED CHANNEL BANDWIDTH..... | 22 |
| 6.1 STANDARD APPLICATION..... | 22 |
| 6.2 TEST PROCEDURE..... | 22 |
| 6.3 SUMMARY OF TEST RESULTS/PLOTS..... | 22 |
| 7. TRANSMITTER UNWANTED EMISSIONS IN THE OUT-OF-BAND DOMAIN..... | 27 |
| 7.1 STANDARD APPLICATION..... | 27 |
| 7.2 TEST PROCEDURE..... | 27 |
| 7.3 SUMMARY OF TEST RESULTS/PLOTS..... | 29 |
| 8. TRANSMITTER UNWANTED EMISSIONS IN THE SPURIOUS DOMAIN..... | 33 |
| 8.1 STANDARD APPLICABLE..... | 33 |
| 8.2 TEST PROCEDURE..... | 33 |
| 8.3 SUMMARY OF TEST RESULTS/PLOTS..... | 33 |
| 9. RECEIVER SPURIOUS EMISSIONS..... | 40 |
| 9.1 STANDARD APPLICABLE..... | 40 |
| 9.2 TEST PROCEDURE..... | 40 |
| 9.3 SUMMARY OF TEST RESULTS/PLOTS..... | 40 |
| 10. RECEIVER BLOCKING..... | 45 |
| 10.1 STANDARD APPLICATION..... | 45 |
| 10.2 TEST PROCEDURE..... | 48 |
| 10.3 TEST SETUP..... | 48 |
| 10.4 SUMMARY OF TEST RESULTS/PLOTS..... | 49 |
| EXHIBIT 1 - EUT PHOTOGRAPHS..... | 50 |
| EXHIBIT 2 - TEST SETUP PHOTO..... | 51 |



Report version

| Version No. | Date of issue | Description |
|-------------|---------------|-------------|
| Rev.00 | 2023-11-05 | Original |
| / | / | / |

WALTEK



1. GENERAL INFORMATION

1.1 Product Description for Equipment Under Test (EUT)

| General Description of EUT | |
|--|----------------------------|
| Product Name: | ABS TWS earbuds |
| Trade Name: | / |
| Model No.: | MO2206 |
| Adding Model(s): | / |
| Rated Voltage: | DC3.7V |
| Battery Capacity: | 30mAh |
| Adapter Model: | / |
| Software Version: | / |
| Hardware Version: | / |
| Radio Technology: | Bluetooth V5.3(EDR Mode) |
| Operation Frequency: | 2402MHz-2480MHz |
| Modulation: | GFSK, $\pi/4$ DQPSK, 8DPSK |
| Antenna Type: | Multilayer Chip Antenna |
| Antenna Gain: | 2.67dBi |
| <p><i>Note: The Antenna Gain is provided by the customer and can affect the validity of results. The test data is gathered from a production sample, provided by the manufacturer.</i></p> | |

| E.1 Product Information (Bluetooth V5.3) | |
|---|---|
| a) Type of modulation: | <input checked="" type="checkbox"/> FHSS <input type="checkbox"/> other forms of modulation |
| b) In case of FHSS modulation: | |
| Max. No. of hopping freq.: | 79 CH |
| Min. No. of hopping freq.: | 15 CH |
| Accumulated Dwell time: | 321.9ms |
| Frequency Occupation(Burst Number) | 4 |
| c) Adaptive / non-adaptive: | adaptive equipment without a non-adaptive mode |
| d) In case of adaptive equipment: | The equipment has implemented an LBT based DAA mechanism |
| e) In case of non-adaptive equipment: | No |
| f) The worst case operational mode for each of the following tests: | |
| RF output power | DH5 |
| Accumulated dwell time | DH5 |
| Minimum frequency occupation | DH5 |
| Occupied channel bandwidth | DH5, 3DH5 (Min, Max) |



| | |
|--|--|
| Transmitter unwanted emissions in the OOB domain | DH5 |
| Transmitter unwanted emissions in the spurious domain | DH5 |
| Receiver spurious emissions | DH5 |
| g) Operating mode(antenna): | Single Antenna Equipment |
| h) In case of smart antenna systems: | No |
| i) Operating frequency range(s) of the equipment: | 2402 MHz to 2480 MHz |
| j) Occupied channel bandwidth(s): | Bandwidth 1(Min): 0.85MHz Bandwidth 2(Max): 1.16MHz |
| k) Type of equipment: | <input checked="" type="checkbox"/> Stand-alone <input type="checkbox"/> Combined equipment <input type="checkbox"/> Plug-in device |
| l) The extreme operating conditions | |
| Extreme voltage range: | Please refer to Section 1.5 |
| Extreme temperature range: | Please refer to Section 1.5 |
| m) The intended combination(s) of the radio equipment power settings and one or more antenna assemblies and their corresponding e.i.r.p levels: | |
| Antenna type: | <input checked="" type="checkbox"/> Multilayer Chip Antenna <input type="checkbox"/> Dedicated Antennas |
| Antenna Gain: | 2.67dBi |
| n) Nominal voltage: | Please refer to Section 1.5 |
| o) Describe the test modes available which can facilitate testing: | Please refer to Section 1.5 |
| p) The equipment type | Bluetooth |
| E.2 Power Level Setting | |
| Highest EIRP value: | -1.63dBm |
| Conducted power: | -4.30dBm |
| Listed as power setting: | Default |
| E.3 Additional Information | |
| Modulation: | GFSK, $\pi/4$ DQPSK, 8DPSK |
| Unmodulated modes: | No |
| Duty cycle: | Continuous operation possible for testing purposes |
| Type of the UUT: | Production models |
| Supporting equipment: | Combined equipment |



1.2 Test Standards

The tests were performed according to following standards:

ETSI EN 300 328 V2.2.2 (2019-07): Wideband transmission systems; Data transmission equipment operating in the 2.4 GHz band; Harmonised Standard for access to radio spectrum.

Maintenance of compliance is the responsibility of the manufacturer. Any modification of the product maybe which result in lowering the emission/immunity should be checked to ensure compliance has been maintained.

1.3 Test Methodology

All measurements contained in this report were conducted with ETSI EN 300328, the equipment under test (EUT) was configured to measure its highest possible emission level. For more detail refer to the Operating Instructions.

1.4 Test Facility

Address of the test laboratory

Laboratory: Waltek Testing Group (Shenzhen) Co., Ltd.

Address: 1/F., Room 101, Building 1, Hongwei Industrial Park, Liuxian 2nd Road, Block 70 Bao'an District, Shenzhen, Guangdong, China

FCC – Registration No.: 125990

Waltek Testing Group (Shenzhen) Co., Ltd. EMC Laboratory has been registered and fully described in a report filed with the FCC (Federal Communications Commission). The acceptance letter from the FCC is maintained in our files. The Designation Number is CN5010, and Test Firm Registration Number is 125990.

Industry Canada (IC) Registration No.: 11464A

The 3m Semi-anechoic chamber of Waltek Testing Group (Shenzhen) Co., Ltd. has been registered by Certification and Engineering Bureau of Industry Canada for radio equipment testing with Registration No.: 11464A.



1.5 EUT Setup and Test Mode

The equipment under test (EUT) was configured to measure its highest possible emission/immunity level. The test modes were adapted according to the operation manual for use, the EUT was operated in the engineering mode to fix the Tx/Rx frequency that was for the purpose of the measurements, more detailed description as follows:

| Test Mode List | | |
|----------------|-------------|-------------------|
| Test Mode | Description | Remark |
| TM1 | EDR | 2402/2441/2480MHz |
| TM2 | Hopping | 2402-2480MHz |

| | NTNV | LTNV | HTNV |
|--------------------|------|-----------|------|
| Temperature (°C) | 20 | -10 | 40 |
| Voltage (V) | 3.7 | | |
| Relative Humidity: | | 45 %. | |
| ATM Pressure: | | 1019 mbar | |

| EUT Cable List and Details | | | |
|----------------------------|------------|---------------------|------------------------|
| Cable Description | Length (m) | Shielded/Unshielded | With / Without Ferrite |
| / | / | / | / |

| Special Cable List and Details | | | |
|--------------------------------|------------|---------------------|------------------------|
| Cable Description | Length (m) | Shielded/Unshielded | With / Without Ferrite |
| / | / | / | / |

| Auxiliary Equipment List and Details | | | |
|--------------------------------------|--------------|-------|---------------|
| Description | Manufacturer | Model | Serial Number |
| / | / | / | / |



1.6 Measurement Uncertainty

| Measurement uncertainty | | |
|----------------------------------|-------------------------|------|
| Parameter | Uncertainty | Note |
| Radio frequency | ± 0.4 ppm | (1) |
| Conducted RF Output Power | ± 0.42 dB | (1) |
| Occupied Bandwidth | $\pm 1 \times 10^{-7}$ | (1) |
| Conducted Power Spectral Density | ± 0.70 dB | (1) |
| Conducted Spurious Emission | ± 2.17 dB | (1) |
| Radiated Spurious Emissions | 30-200MHz ± 4.52 dB | (1) |
| | 0.2-1GHz ± 5.56 dB | (1) |
| | 1-6GHz ± 3.84 dB | (1) |
| | 6-18GHz ± 3.92 dB | (1) |

(1) This uncertainty represents an expanded uncertainty expressed at approximately the 95% confidence level using a coverage factor of $k=1.96$.

WALTEK



1.7 Test Equipment List and Details

| Description | Manufacturer | Model | Serial Number | Cal Date | Due Date |
|---|-----------------|-------------|---------------|------------|------------|
| Spectrum Analyzer | Agilent | N9020A | US47140102 | 2023-02-25 | 2024-02-24 |
| Signal Generator | Agilent | 83752A | 3610A01453 | 2023-02-25 | 2024-02-24 |
| Vector Signal Generator | Agilent | N5182A | MY47070202 | 2023-02-25 | 2024-02-24 |
| Power Sensor | Agilent | U2021XA | MY54250019 | 2023-02-25 | 2024-02-24 |
| Power Sensor | Agilent | U2021XA | MY54250021 | 2023-02-25 | 2024-02-24 |
| Simultaneous Sampling | Agilent | U2531A | TW54243509 | 2023-02-25 | 2024-02-24 |
| Communication Tester | HP | 8921A | / | 2023-02-25 | 2024-02-24 |
| Temperature&Humidity Chamber | / | HTC-1 | / | 2023-02-25 | 2024-02-24 |
| Universal Radio Communication Tester | Rohde & Schwarz | CMW500 | 148650 | 2023-02-25 | 2024-02-24 |
| <input type="checkbox"/> Chamber A: Below 1GHz | | | | | |
| Spectrum Analyzer | Rohde & Schwarz | FSP30 | 836079/035 | 2023-02-25 | 2024-02-24 |
| EMI Test Receiver | Rohde & Schwarz | ESVB | 825471/005 | 2023-02-25 | 2024-02-24 |
| Amplifier | HP | 8447F | 2805A03475 | 2023-02-25 | 2024-02-24 |
| Loop Antenna | Schwarz beck | FMZB 1516 | 9773 | 2021-03-20 | 2024-03-19 |
| Trilog Broadband Antenna | Schwarz beck | VULB9163 | 9163-333 | 2023-03-20 | 2026-03-19 |
| <input type="checkbox"/> Chamber A: Above 1GHz | | | | | |
| Spectrum Analyzer | Rohde & Schwarz | FSP30 | 836079/035 | 2023-02-25 | 2024-02-24 |
| Spectrum Analyzer | Rohde & Schwarz | FSP40 | 100612 | 2023-02-25 | 2024-02-24 |
| EMI Test Receiver | Rohde & Schwarz | ESVB | 825471/005 | 2023-02-25 | 2024-02-24 |
| Amplifier | C&D | PAP-1G18 | 14918 | 2023-02-25 | 2024-02-24 |
| Horn Antenna | ETS | 3117 | 00086197 | 2021-03-19 | 2024-03-18 |
| DRG Horn Antenna | A.H. SYSTEMS | SAS-574 | 571 | 2021-03-19 | 2024-03-18 |
| Pre-amplifier | Schwarzbeck | BBV 9721 | 9721-031 | 2023-02-25 | 2024-02-24 |
| <input type="checkbox"/> Chamber B: Below 1GHz | | | | | |
| Trilog Broadband Antenna | Schwarz beck | VULB9163(B) | 9163-635 | 2021-04-09 | 2024-04-08 |
| Amplifier | Agilent | 8447D | 2944A10457 | 2023-02-25 | 2024-02-24 |
| EMI Test Receiver | Rohde & Schwarz | ESPI | 101391 | 2023-02-25 | 2024-02-24 |
| <input checked="" type="checkbox"/> Chamber C: Below 1GHz | | | | | |
| EMI Test Receiver | Rohde & Schwarz | ESIB 26 | 100401 | 2023-02-25 | 2024-02-24 |
| Trilog Broadband Antenna | Schwarz beck | VULB 9168 | 1194 | 2021-05-28 | 2024-05-27 |



| | | | | | |
|---|-----------------|-------------|-------------|------------|------------|
| Loop Antenna | Schwarz beck | FMZB 1516 | 9773 | 2021-03-20 | 2024-03-19 |
| Amplifier | HP | 8447F | 2944A03869 | 2023-02-25 | 2024-02-24 |
| <input checked="" type="checkbox"/> Chamber C: Above 1GHz | | | | | |
| EMI Test Receiver | Rohde & Schwarz | ESIB 26 | 100401 | 2023-02-25 | 2024-02-24 |
| Horn Antenna | POAM | RTF-118A | 1820 | 2023-03-10 | 2026-03-09 |
| Amplifier | Tonscend | TAP01018050 | AP22E806235 | 2023-02-25 | 2024-02-24 |
| DRG Horn Antenna | A.H. SYSTEMS | SAS-574 | 571 | 2021-03-19 | 2024-03-18 |
| Pre-amplifier | Schwarzbeck | BBV 9721 | 9721-031 | 2023-02-25 | 2024-02-24 |

| Software List | | | |
|--|--------------|---------|---------|
| Description | Manufacturer | Model | Version |
| EMI Test Software (Radiated Emission)* | Farad | EZ-EMC | RA-03A1 |
| RF Test System | TST | TST-258 | V2.0 |
| RF Test System | Ascentest | AT890 | V3.0 |

*Remark: indicates software version used in the compliance certification testing





2. SUMMARY OF TEST RESULTS

| Standards | Reference | Description of Test Item | Result |
|------------|---------------------|--|--------|
| EN 300 328 | 4.3.1.2 / 4.3.2.2 | RF Output Power | Passed |
| | 4.3.2.3 | Power Spectral Density | N/A |
| | 4.3.1.3 / 4.3.2.4 | Duty Cycle, Tx-sequence, Tx-gap | N/A |
| | 4.3.1.4 | Accumulated Transmit Time, Frequency Occupation and Hopping Sequence | Passed |
| | 4.3.1.5 | Hopping Frequency Separation | Passed |
| | 4.3.1.6 / 4.3.2.5 | Medium Utilisation (MU) Factor | N/A |
| | 4.3.1.7 / 4.3.2.6 | Adaptivity (Adaptive Frequency Hopping) | N/A |
| | 4.3.1.8 / 4.3.2.7 | Occupied Channel Bandwidth | Passed |
| | 4.3.1.9 / 4.3.2.8 | Transmitter Unwanted Emissions in the Out-of-band Domain | Passed |
| | 4.3.1.10 / 4.3.2.9 | Transmitter Unwanted Emissions in the Spurious Domain | Passed |
| | 4.3.1.11 / 4.3.2.10 | Receiver Spurious Emissions | Passed |
| | 4.3.1.12 / 4.3.2.11 | Receiver Blocking | Passed |
| | 4.3.1.13 / 4.3.2.12 | Geo-location capability | N/A |

Passed: The EUT complies with the essential requirements in the standard.
 Failed: The EUT does not comply with the essential requirements in the standard.
 N/A: Not applicable.



3. RF Output Power

3.1 Standard Applicable

According to Section 4.3.1.2.3, the maximum RF output power for adaptive Frequency Hopping equipment shall be equal to or less than 20 dBm. The maximum RF output power for non-adaptive Frequency Hopping equipment, shall be declared by the supplier. The maximum RF output power for this equipment shall be equal to or less than the value declared by the supplier. This declared value shall be equal to or less than 20 dBm.

According to Section 4.3.2.2.3, for adaptive equipment using wide band modulations other than FHSS, the maximum RF output power shall be 20 dBm. The maximum RF output power for non-adaptive equipment shall be declared by the supplier and shall not exceed 20 dBm. For non-adaptive equipment using wide band modulations other than FHSS, the maximum RF output power shall be equal to or less than the value declared by the supplier.

This limit shall apply for any combination of power level and intended antenna assembly.

3.2 Test Procedure

According to section 5.4.2.2.1.2 of the standard EN 300328, the test procedure shall be as follows:

Step 1:

- Use a fast power sensor suitable for 2,4 GHz and capable of 1 MS/s.
- Use the following settings: - Sample speed 1 MS/s or faster.
- The samples must represent the power of the signal.
- Measurement duration: For non-adaptive equipment: equal to the observation period defined in clauses 4.3.1.3.2 or clause 4.3.2.4.2. For adaptive equipment, the measurement duration shall be long enough to ensure a minimum number of bursts (at least 10) are captured.

NOTE 1: For adaptive equipment, to increase the measurement accuracy, a higher number of bursts may be used.

Step 2:

- For conducted measurements on devices with one transmit chain:
 - Connect the power sensor to the transmit port, sample the transmit signal and store the raw data. Use these stored samples in all following steps.
- For conducted measurements on devices with multiple transmit chains:
 - Connect one power sensor to each transmit port for a synchronous measurement on all transmit ports.
 - Trigger the power sensors so that they start sampling at the same time. Make sure the time difference between the samples of all sensors is less than half the time between two samples.
 - For each individual sampling point (time domain), sum the coincident power samples of all ports and store them. Use these summed samples in all following steps..



Step 3:

- Find the start and stop times of each burst in the stored measurement samples.

The start and stop times are defined as the points where the power is at least 30 dB below the highest value of the stored samples in step 2.

NOTE 2: In case of insufficient dynamic range, the value of 30 dB may need to be reduced appropriately.

Step 4:

- Between the start and stop times of each individual burst calculate the RMS power over the burst using the formula below. Save these Pburst values, as well as the start and stop times for each burst.

$$P_{burst} = \frac{1}{k} \sum_{n=1}^k P_{sample}(n)$$

with 'k' being the total number of samples and 'n' the actual sample number

Step 5:

- The highest of all Pburst values (value "A" in dBm) will be used for maximum e.i.r.p. calculations.

Step 6:

- Add the (stated) antenna assembly gain "G" in dBi of the individual antenna.
- If applicable, add the additional beamforming gain "Y" in dB.
- If more than one antenna assembly is intended for this power setting, the maximum overall antenna gain (G or G + Y) shall be used.
- The RF Output Power (P) shall be calculated using the formula below: $P = A + G + Y$
- This value, which shall comply with the limit given in clause 4.3.1.2.3 or clause 4.3.2.2.3, shall be recorded in the test report.

3.3 Summary of Test Results



| BR/EDR | | | | |
|-----------------|---------------|------------|-------------|--------|
| Test conditions | Modulation | EIRP (dBm) | Limit (dBm) | Result |
| NTNV | GFSK | -3.88 | 20.00 | Pass |
| | $\pi/4$ DQPSK | -2.54 | | |
| | 8DPSK | -1.63 | | |
| LTV | GFSK | -3.89 | | |
| | $\pi/4$ DQPSK | -2.55 | | |
| | 8DPSK | -1.64 | | |
| HTNV | GFSK | -3.91 | | |
| | $\pi/4$ DQPSK | -2.57 | | |
| | 8DPSK | -1.68 | | |

WALTEK

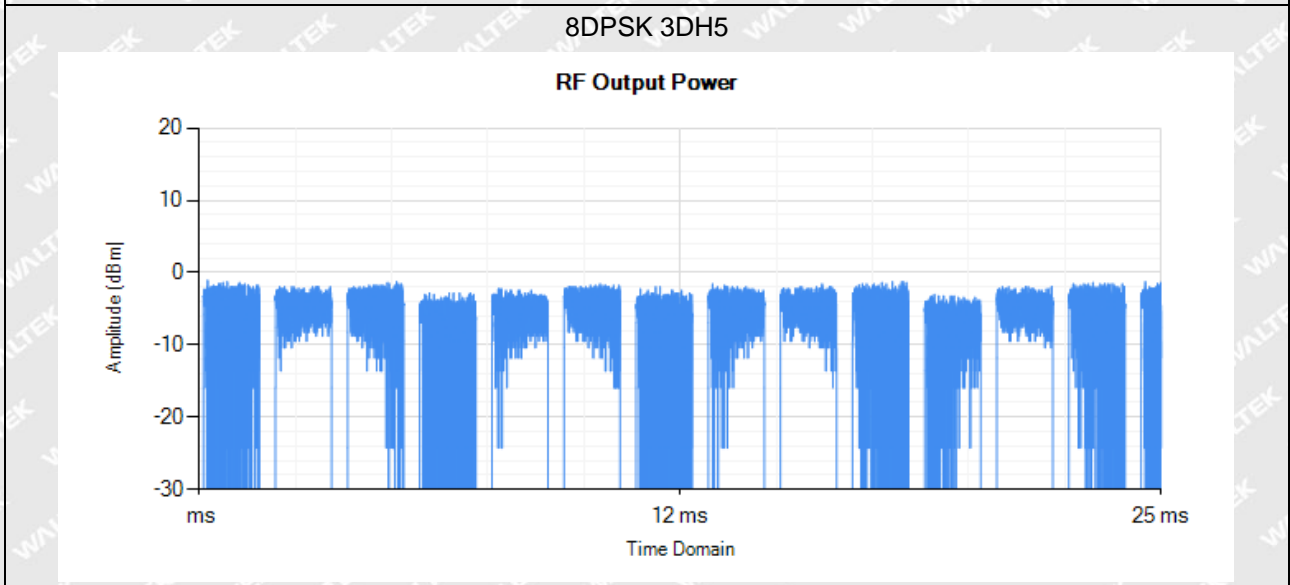
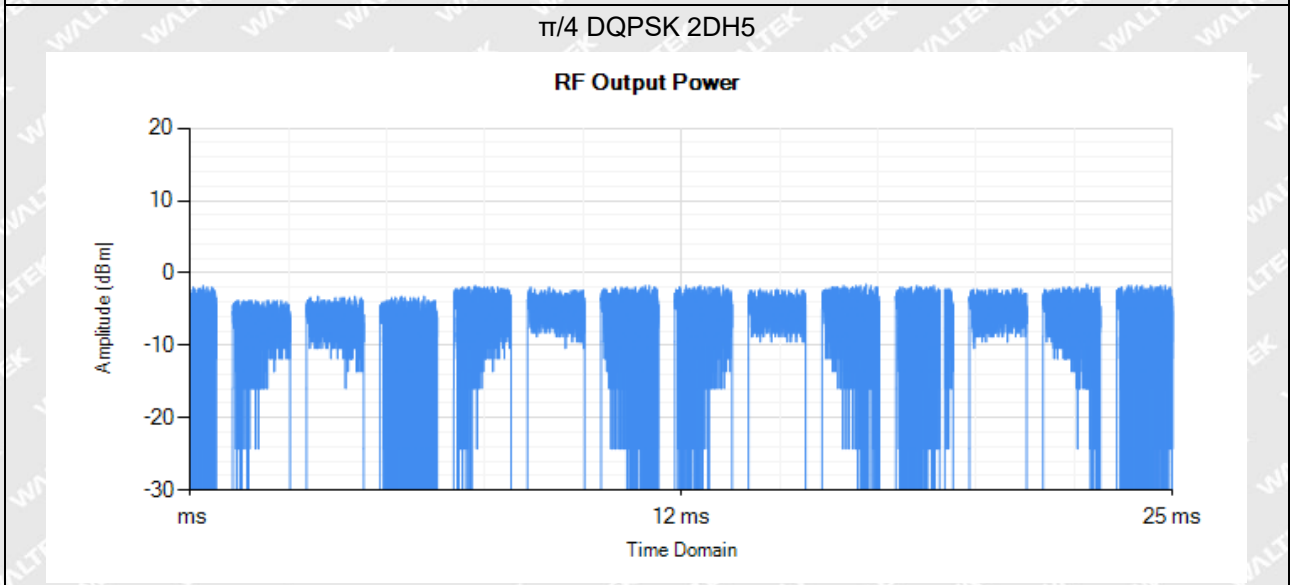
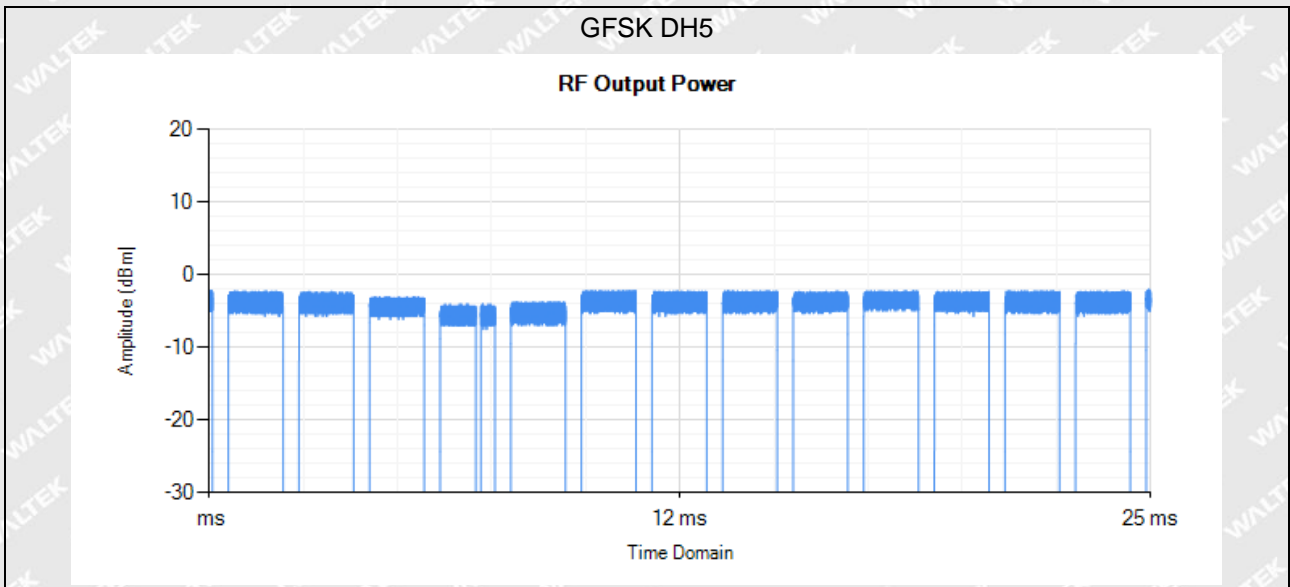



4. Accumulated Transmit Time, Frequency Occupation and Hopping Sequence

4.1 Standard Application

According to section 4.3.1.4.3,

Adaptive Frequency Hopping equipment shall be capable of operating over a minimum of 70 % of the band specified in clause 1.

The Accumulated Transmit Time on any hopping frequency shall not be greater than 400 ms within any observation period of 400 ms multiplied by the minimum number of hopping frequencies (N) that have to be used.

In order for the equipment to comply with the Frequency Occupation requirement, it shall meet either of the following two options:

Option 1: Each hopping frequency of the hopping sequence shall be occupied at least once within a period not exceeding four times the product of the dwell time and the number of hopping frequencies in use.

Option 2: The occupation probability for each frequency shall be between $((1 / U) \times 25 \%)$ and 77 % where U is the number of hopping frequencies in use.

The Hopping Sequence(s) shall contain at least N hopping frequencies where N is either 5 or the result of 15 MHz divided by the minimum Hopping Frequency Separation in MHz, whichever is the greater.

4.2 Test procedure

According to section 5.4.4.2.1, the test procedure shall be as follows:

Step 1:

- The output of the transmitter shall be connected to a spectrum analyzer or equivalent.
- The analyzer shall be set as follows:
 - Centre Frequency: Equal to the hopping frequency being investigated
 - Frequency Span: 0 Hz
 - RBW: ~ 50 % of the Occupied Channel Bandwidth
 - VBW: \geq RBW
 - Detector Mode: RMS
 - Sweep time: Equal to the applicable observation period (see clause 4.3.1.4.3.1 or clause 4.3.1.4.3.2)
 - Number of sweep points: 30 000
 - Trace mode: Clear / Write
 - Trigger: Free Run

Step 2:

- Save the trace data to a file for further analysis by a computing device using an appropriate software application or program.



Reference No.: WTF23X10227453W001

Step 3:

- Identify the data points related to the frequency being investigated by applying a threshold.

The data points resulting from transmissions on the hopping frequency being investigated are assumed to have much higher levels compared to data points resulting from transmissions on adjacent hopping frequencies. If a clear determination between these transmissions is not possible, the RBW in step 1 shall be further reduced. In addition, a channel filter may be used.

- Count the number of data points identified as resulting from transmissions on the frequency being investigated and multiply this number by the time difference between two consecutive data points.

Step 4:

- The result in step 3 is the accumulated Dwell Time which shall comply with the limit provided in clauses 4.3.1.4.3.1 or 4.3.1.4.3.2 and which shall be recorded in the test report.

Step 5:

NOTE 1: This step is only applicable for equipment implementing Option 1 in clause 4.3.1.4.3.1 or clause 4.3.1.4.3.2 for complying with the Frequency Occupation requirement and the manufacturer decides to demonstrate compliance with this requirement via measurement.

- Make the following changes on the analyser and repeat step 2 and step 3.

Sweep time: $4 \times \text{Dwell Time} \times \text{Actual number of hopping frequencies in use}$

The hopping frequencies occupied by the equipment without having transmissions during the dwell time (blacklisted frequencies) should be taken into account in the actual number of hopping frequencies in use. If this number cannot be determined (number of blacklisted frequencies unknown) it shall be assumed that the equipment uses the maximum possible number of hopping frequencies.

- The result shall be compared to the limit for the Frequency Occupation defined in clause 4.3.1.4.3.1 or clause 4.3.1.4.3.2. The result of this comparison shall be recorded in the test report.

Step 6:

- Make the following changes on the analyzer:

- Start Frequency: 2 400MHz
- Stop Frequency: 2 483.5MHz
- RBW: ~ 50 % of the Occupied Channel Bandwidth (single hopping frequency)
- VBW: \geq RBW
- Detector Mode: RMS
- Sweep time: 1s
- Trace Mode: Max Hold
- Trigger: Free Run

NOTE 2: The above sweep time setting may result in long measuring times. To avoid such long measuring times, an FFT analyser could be used.

- Wait for the trace to stabilize. Identify the number of hopping frequencies used by the hopping sequence.
- The result shall be compared to the limit (value N) defined in clause 4.3.1.4.3.1 or clause 4.3.1.4.3.2. This value shall be recorded in the test report. For equipment with blacklisted frequencies, it might not be possible



Reference No.: WTF23X10227453W001

to verify the number of hopping frequencies in use. However they shall comply with the requirement for Accumulated Transmit Time and Frequency Occupation assuming the minimum number of hopping frequencies (N) defined in clause 4.3.1.4.3.1 or clause 4.3.1.4.3.2 is used.

Step 7:

- For adaptive systems, using the lowest and highest -20 dB points from the total spectrum envelope obtained in step 6, it shall be verified whether the system uses 70 % of the band specified in clause 1. The result shall be recorded in the test report.

RBW/RBW=500/500kHz

4.3 Summary of Test Results/Plots

| Modulation | Test Channel | Packet | Maximum Accumulated Dwell Time | |
|------------|--------------|--------|--------------------------------|-------|
| | | | Acc. Dwell Time | Limit |
| | | | ms | ms |
| GFSK | 2402MHz | DH5 | 321.9 | <400 |
| | 2480MHz | DH5 | 320.3 | <400 |

Test Period: 400ms X Minimum number of hopping frequencies (N)
 Accumulated Dwell Time = Time slot length (Dwell time) X Number of data points within a test period
 Note: Test data is corrected with the worst case, which the packet length is GFSK DH5

| Modulation | Test Channel | Packet | Frequency Occupation requirement | |
|------------|--------------|--------|----------------------------------|---------------------|
| | | | Burst Number | Limit(Burst Number) |
| | | | GFSK | 2402MHz |
| 2480MHz | DH5 | 4 | | ≥1 |

Test Period: 4 X Dwell time X Minimum number of hopping frequencies (N)
 Occupation Time = Time slot length (Dwell time) X Number of data points within a test period
 Note: Test data is corrected with the worst case, which the packet length is GFSK DH5

| Frequency Band | Number of Hopping Frequencies (N) | Limit | Result |
|----------------|-----------------------------------|--------------------------|--------|
| 2400-2483.5MHz | 79 | 15 | Passed |
| | Band Allocation(%) | Limit Band Allocation(%) | Result |
| | 95.33 | ≥70 | Passed |



5. Hopping Frequency Separation

5.1 Standard Application

According to section 4.3.1.5.3, for adaptive Frequency Hopping equipment, the minimum Hopping Frequency Separation shall be 100 kHz.

Adaptive Frequency Hopping equipment, which for one or more hopping frequencies, has switched to a non-adaptive mode because interference was detected on all these hopping positions with a level above the threshold level defined in clause 4.3.1.7.2.2 or clause 4.3.1.7.3.2, is allowed to continue to operate with a minimum Hopping Frequency Separation of 100kHz on these hopping frequencies as long as the interference is present on these frequencies. The equipment shall continue to operate in an adaptive mode on other hopping frequencies.

Adaptive Frequency Hopping equipment which decided to operate in a non-adaptive mode on one or more hopping frequencies without the presence of interference, shall comply with the limit in clause 4.3.1.5.3.1 for these hopping frequencies as well as with all other requirements applicable to non-adaptive frequency hopping equipment.

5.2 Test procedure

According to the section 5.4.5.2.1, the option 2 test method shall be used.

Step 1:

The output of the transmitter shall be connected to a spectrum analyzer or equivalent.

The analyzer shall be set as follows:

- Centre Frequency: Centre of the two adjacent hopping frequencies
- Frequency Span: Sufficient to see the complete power envelope of both hopping frequencies
- RBW: 1 % of the Span
- VBW: 3 × RBW
- Detector Mode: RMS
- Trace Mode: Max Hold
- Sweep Time: 1s

NOTE: Depending on the nature of the signal (modulation), it might be required to use a much longer sweep time, e.g. in case switching transients are present in the signals to be investigated.

Step 2:

- Wait for the trace to stabilize.
- Use the marker-delta function to determine the Hopping Frequency Separation between the centres of the two adjacent hopping frequencies (e.g. by indentifying peaks or notches at the centre of the power envelope for the two adjacent signals). This value shall be compared with the limits defined in clause 4.3.1.5.3 and shall be recorded in the test report.

RBW/VBW=30/100kHz



5.3 Summary of Test Results/Plots

| Test Mode | Channel Separation | Limit |
|---------------|--------------------|-------|
| | MHz | MHz |
| GFSK | 1.002 | >0.1 |
| $\pi/4$ DQPSK | 1.002 | >0.1 |
| 8DPSK | 1.002 | >0.1 |

WALTEK

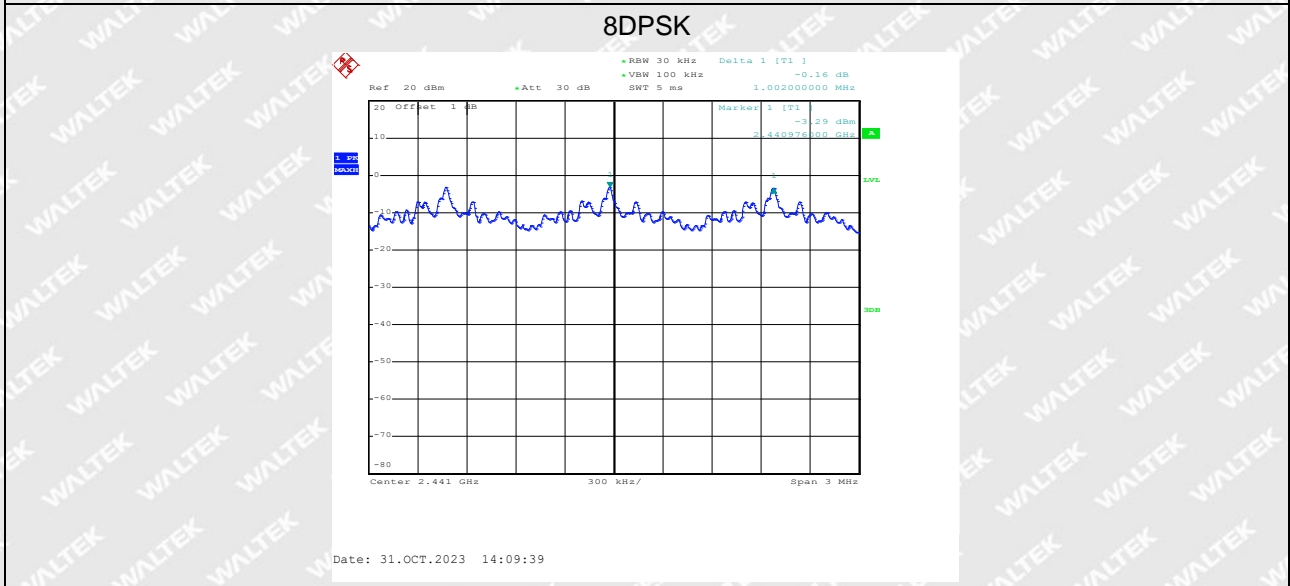
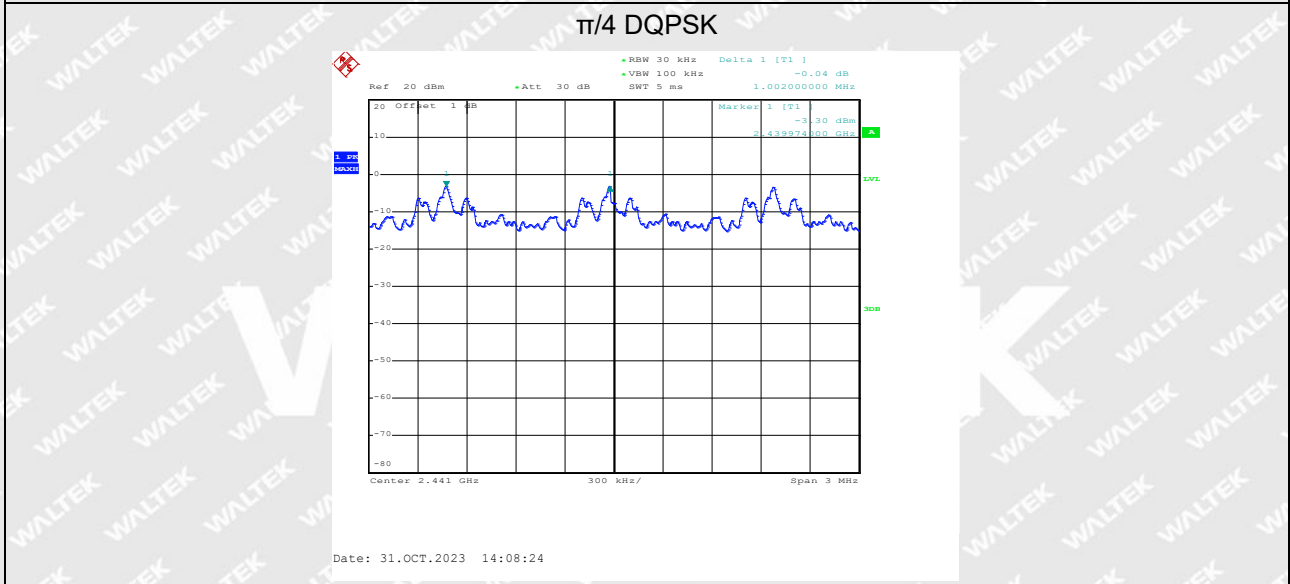
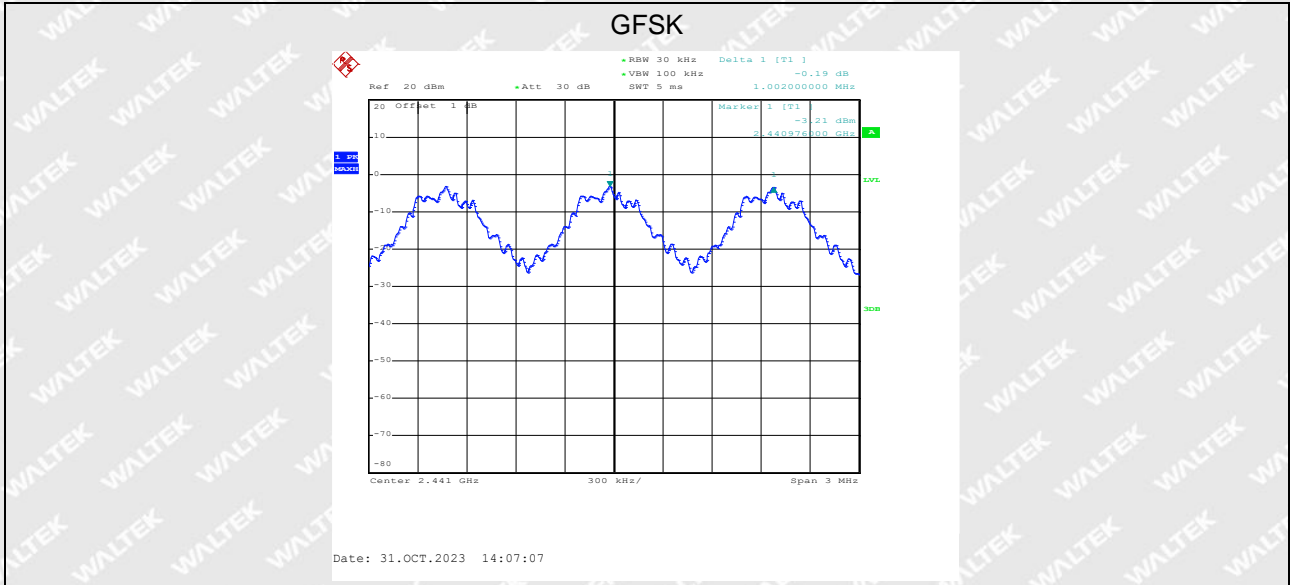



6. Occupied Channel Bandwidth

6.1 Standard Application

According to section 4.3.1.8.3, the Occupied Channel Bandwidth for each hopping frequency shall fall completely within the band given in clause 1.

For non-adaptive Frequency Hopping equipment with e.i.r.p greater than 10 dBm, the Occupied Channel Bandwidth for every occupied hopping frequency shall be equal to or less than the value declared by the supplier. This declared value shall not be greater than 5MHz.

According to section 4.3.2.7.3, the Occupied Channel Bandwidth shall fall completely within the band given in clause 1. In addition, for non-adaptive systems using wide band modulations other than FHSS and with e.i.r.p greater than 10 dBm, the occupied channel bandwidth shall be less than 20 MHz.

6.2 Test procedure

According to the section 5.4.7.2.1, the measurement procedure shall be as follows:

Step 1:

Connect the UUT to the spectrum analyser and use the following settings:

- Centre Frequency: The centre frequency of the channel under test
- Resolution BW: ~ 1 % of the span without going below 1 %
- Video BW: $3 \times \text{RBW}$
- Frequency Span for frequency hopping equipment: Lowest frequency separation that is used within the hopping sequence
- Frequency Span for other types of equipment: $2 \times \text{Nominal Channel Bandwidth}$ (e.g. 40 MHz for a 20 MHz channel)
- Detector Mode: RMS
- Trace Mode: Max Hold
- Sweep time: 1 s

Step 2:

Wait until the trace is completed.

Find the peak value of the trace and place the analyser marker on this peak.

Step 3:

Use the 99 % bandwidth function of the spectrum analyser to measure the Occupied Channel Bandwidth of the UUT. This value shall be recorded.

6.3 Summary of Test Results/Plots



| Mode | Channel | Measured Frequency (MHz) | | Limit (MHz) | Result |
|---------------|---------|--------------------------|---------|-----------------|--------|
| | | Low | High | | |
| GFSK | Low | 2401.54 | 2402.39 | 2400.00~2483.50 | Pass |
| | High | 2479.54 | 2480.39 | | |
| $\pi/4$ DQPSK | Low | 2401.39 | 2402.54 | 2400.00~2483.50 | Pass |
| | High | 2479.39 | 2480.54 | | |
| 8DPSK | Low | 2401.39 | 2402.55 | 2400.00~2483.50 | Pass |
| | High | 2479.38 | 2480.54 | | |

WALTEK

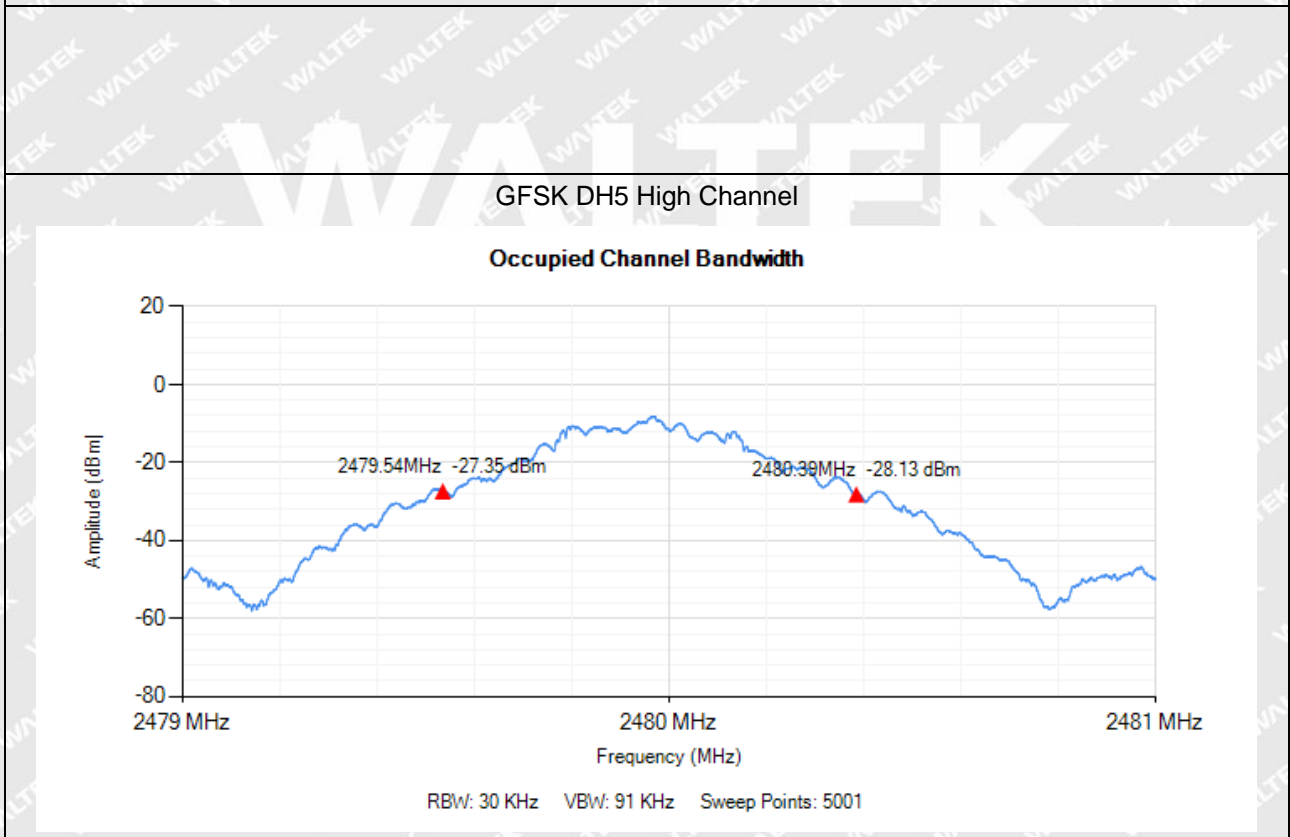
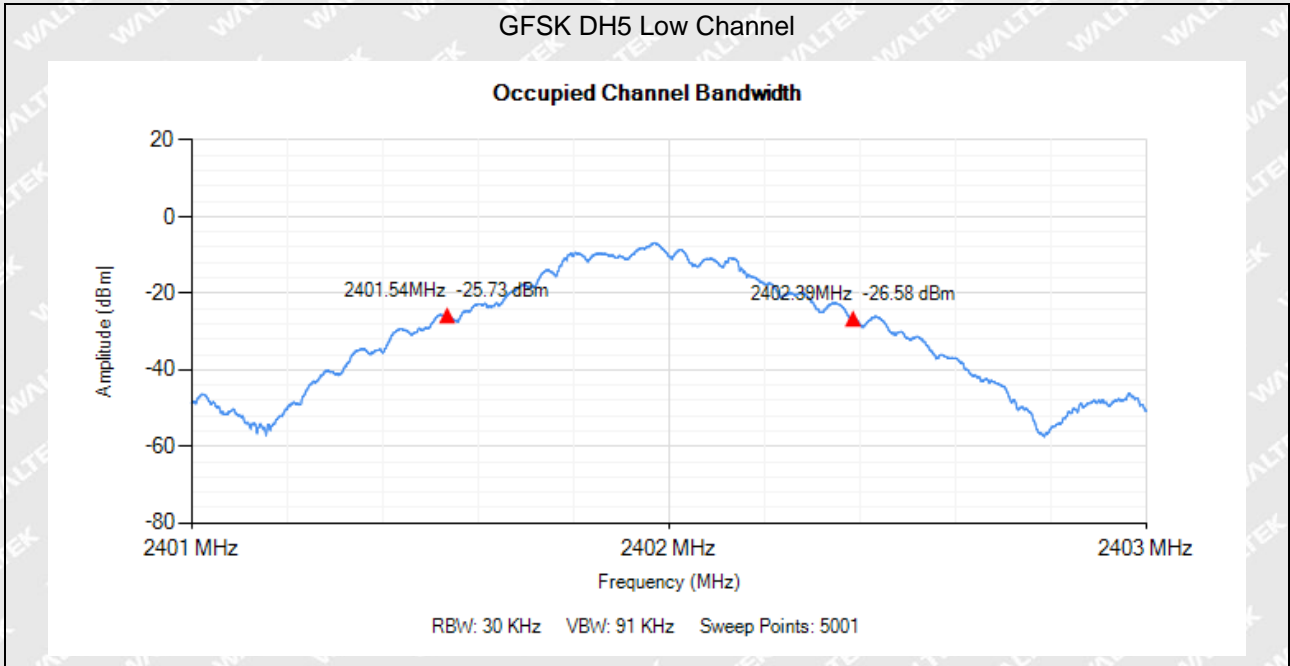

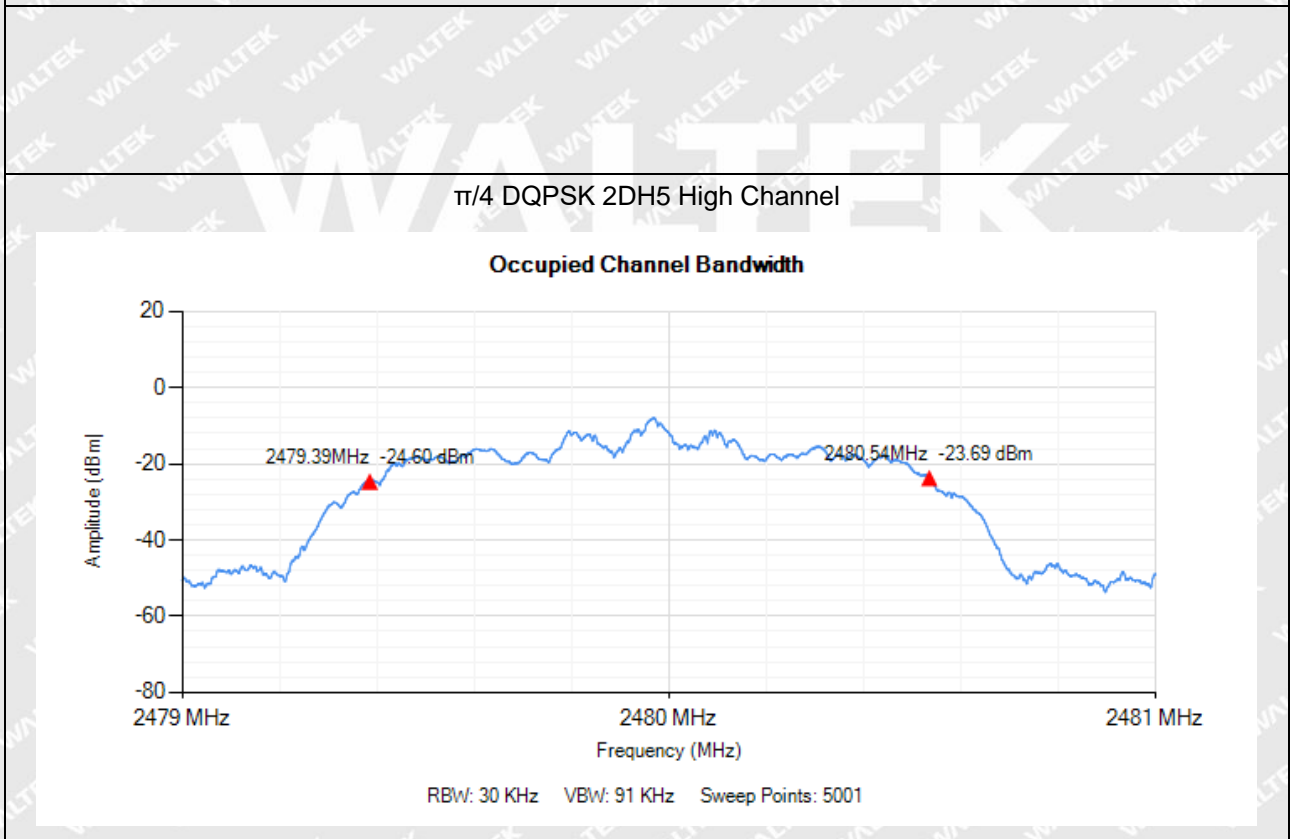
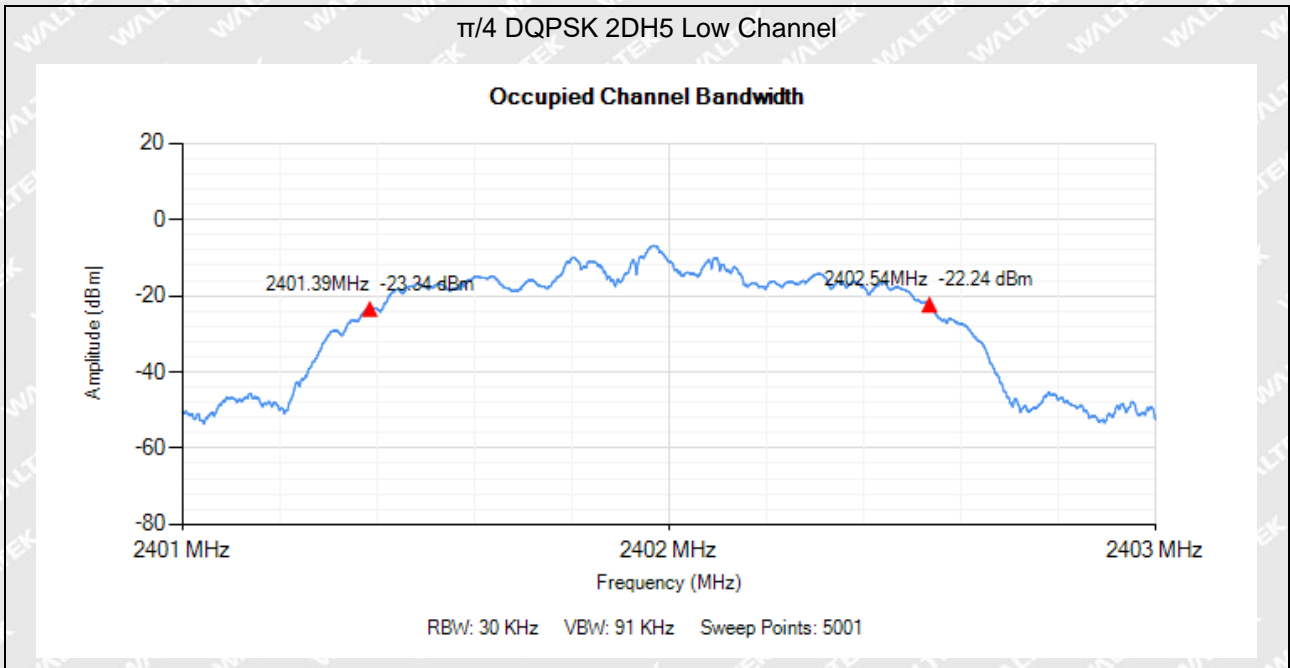

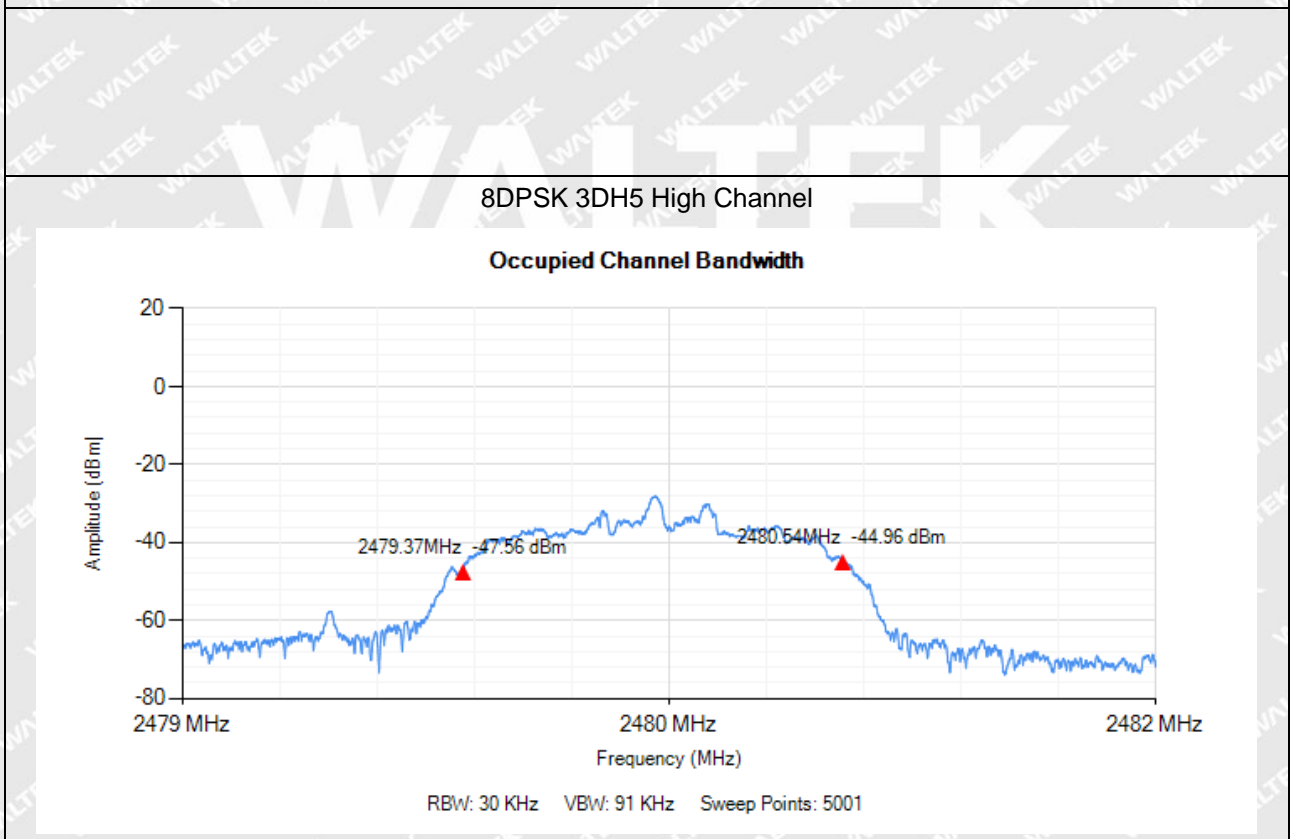
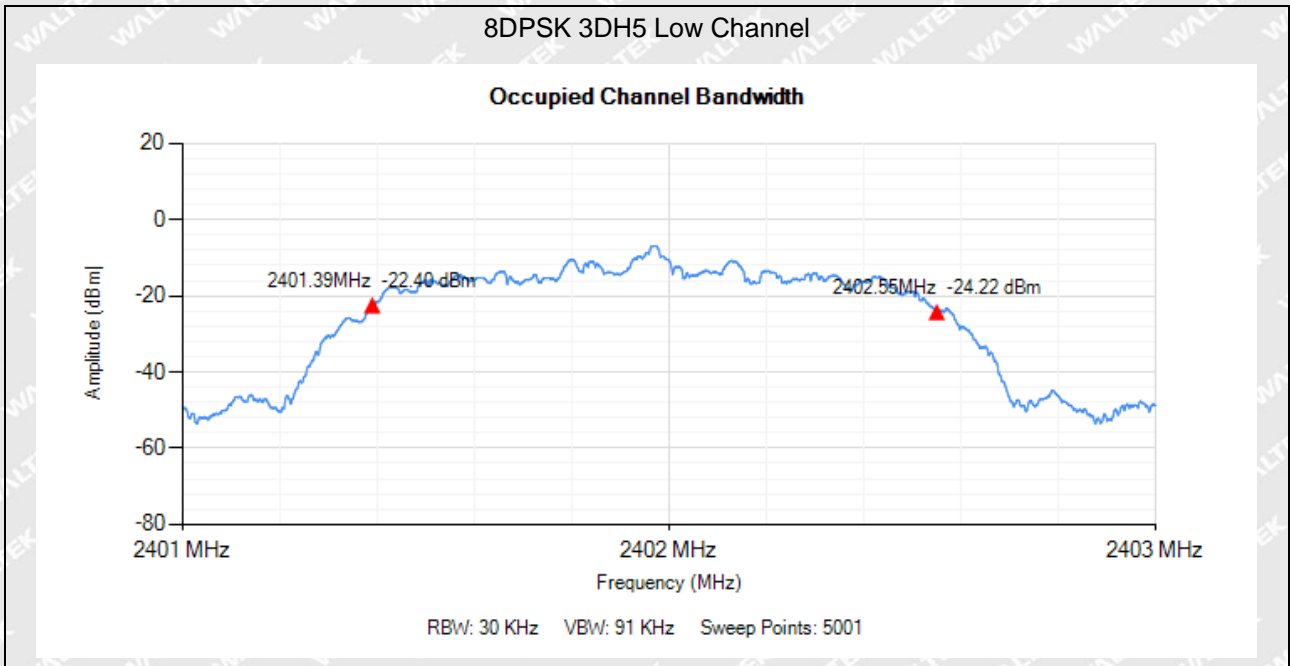



7. Transmitter Unwanted Emissions in the Out-of-band Domain

7.1 Standard Application

According to section 4.3.1.9.3&4.3.2.8.3, the transmitter unwanted emissions in the out-of-band domain but outside the allocated band, shall not exceed the values provided by the mask in figure below:

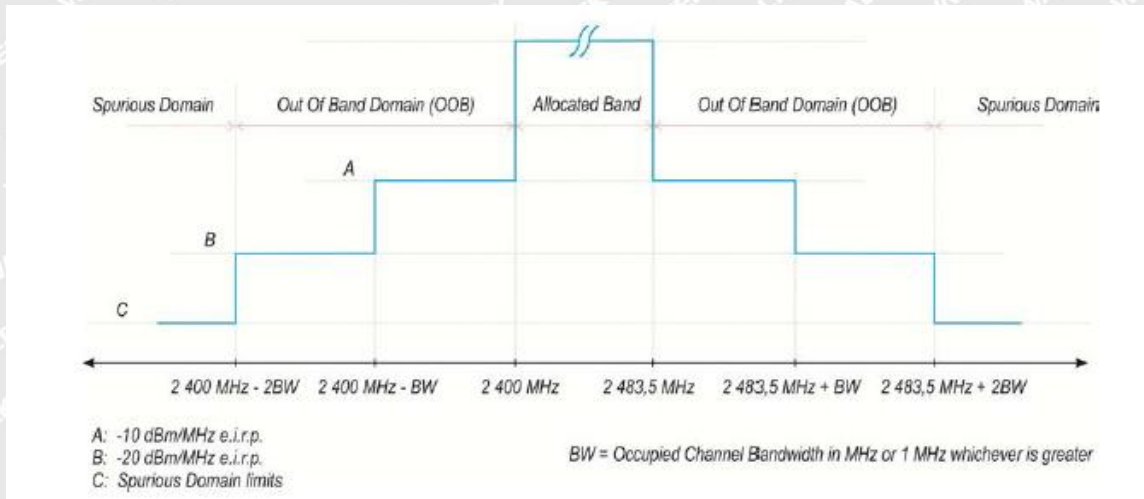

Within the 2400MHz to 2483.5MHz band, the Out-of-band emissions are fulfilled by compliance with the Occupied Channel Bandwidth requirement.

7.2 Test procedure

According to the section 5.4.8.2.1, the measurement procedure shall be as follows:

The Out-of-band emissions within the different horizontal segments of the mask provided in figures 1 and 3 shall be measured using the steps below. This method assumes the spectrum analyser is equipped with the Time Domain Power option.

Step 1:

- Connect the UUT to the spectrum analyser and use the following settings:
 - Centre Frequency: 2484MHz
 - Span: 0Hz
 - Resolution BW: 1MHz
 - Filter mode: Channel filter
 - Video BW: 3MHz
 - Detector Mode: RMS
 - Trace Mode: Max Hold
 - Sweep Mode: Continuous
 - Sweep Points: Sweep Time [s] / (1 μ s) or 5 000 whichever is greater
 - Trigger Mode: Video trigger

NOTE 1: In case video triggering is not possible, an external trigger source may be used.



Reference No.: WTF23X10227453W001

- Sweep Time: > 120 % of the duration of the longest burst detected during the measurement of the RF Output Power

Step 2: (segment 2483.5MHz to 2483.5MHz + BW)

- Adjust the trigger level to select the transmissions with the highest power level.
- For frequency hopping equipment operating in a normal hopping mode, the different hops will result in signal bursts with different power levels. In this case the burst with the highest power level shall be selected.
- Set a window (start and stop lines) to match with the start and end of the burst and in which the RMS power shall be measured using the Time Domain Power function.
- Select RMS power to be measured within the selected window and note the result which is the RMS power within this 1MHz segment (2 483.5MHz to 2 484.5MHz). Compare this value with the applicable limit provided by the mask.
- Increase the centre frequency in steps of 1MHz and repeat this measurement for every 1MHz segment within the range 2483.5MHz to 2483.5MHz + BW. The centre frequency of the last 1MHz segment shall be set to 2483.5MHz + BW – 0.5MHz (which means this may partly overlap with the previous 1MHz segment).

Step 3: (segment 2483.5MHz + BW to 2483.5MHz + 2BW)

- Change the centre frequency of the analyser to 2 484 MHz + BW and perform the measurement for the first 1 MHz segment within range 2483.5MHz + BW to 2483.5MHz + 2BW. Increase the centre frequency in 1 MHz steps and repeat the measurements to cover this whole range. The centre frequency of the last 1MHz segment shall be set to 2483.5MHz + 2BW – 0.5MHz.

Step 4: (segment 2400MHz - BW to 2400MHz)

- Change the centre frequency of the analyser to 2399.5MHz and perform the measurement for the first 1MHz segment within range 2400MHz - BW to 2400MHz. Reduce the centre frequency in 1 MHz steps and repeat the measurements to cover this whole range. The centre frequency of the last 1 MHz segment shall be set to 2 400MHz - 2BW + 0.5MHz.

Step 5: (segment 2 400MHz - 2BW to 2 400MHz - BW)

- Change the centre frequency of the analyser to 2399.5MHz - BW and perform the measurement for the first 1 MHz segment within range 2400MHz - 2BW to 2400MHz - BW. Reduce the centre frequency in 1MHz steps and repeat the measurements to cover this whole range. The centre frequency of the last 1MHz segment shall be set to 2400MHz - 2BW + 0.5MHz.

Step 6:

- In case of conducted measurements on equipment with a single transmit chain, the declared antenna assembly gain "G" in dBi shall be added to the results for each of the 1 MHz segments and compared with the limits provided by the mask given in figure 1 or figure 3. If more than one antenna assembly is intended for this power setting, the antenna with the highest gain shall be considered.
- In case of conducted measurements on smart antenna systems (equipment with multiple transmit chains), the measurements need to be repeated for each of the active transmit chains. The declared antenna assembly gain "G" in dBi for a single antenna shall be added to these results. If more than one antenna assembly is intended for this power setting, the antenna with the highest gain shall be considered.



Comparison with the applicable limits shall be done using any of the options given below:

- Option 1: the results for each of the transmit chains for the corresponding 1 MHz segments shall be added. The additional beamforming gain "Y" in dB shall be added as well and the resulting values compared with the limits provided by the mask given in figure 1 or figure 3.

NOTE 2: A ch refers to the number of active transmit chains.

It shall be recorded whether the equipment complies with the mask provided in figure 1 or figure 3.

RBW=1MHz VBW=3MHz

7.3 Summary of Test Results/Plots

| Test CH. | Test Segment | Max. Emissions Reading (dBm) | Limit |
|---|-------------------------|------------------------------|-------|
| | MHz | Normal | dBm |
| Test Mode: GFSK DH5 | | | |
| Low | 2400-BW to 2400 | -48.561 | -10 |
| | 2400-2BW to 2400-BW | -54.521 | -20 |
| High | 2483.5 to 2483.5+BW | -57.529 | -10 |
| | 2483.5+BW to 2483.5+2BW | -59.689 | -20 |
| Test Mode: $\pi/4$ DQPSK 2DH5 | | | |
| Low | 2400-BW to 2400 | -48.541 | -10 |
| | 2400-2BW to 2400-BW | -56.541 | -20 |
| High | 2483.5 to 2483.5+BW | -58.959 | -10 |
| | 2483.5+BW to 2483.5+2BW | -60.299 | -20 |
| Test Mode: 8DPSK 3DH5 | | | |
| Low | 2400-BW to 2400 | -49.951 | -10 |
| | 2400-2BW to 2400-BW | -56.521 | -20 |
| High | 2483.5 to 2483.5+BW | -58.309 | -10 |
| | 2483.5+BW to 2483.5+2BW | -60.249 | -20 |
| Note 1: BW please refer to section 7.3 | | | |
| Note 2: the data just list the worst cases | | | |

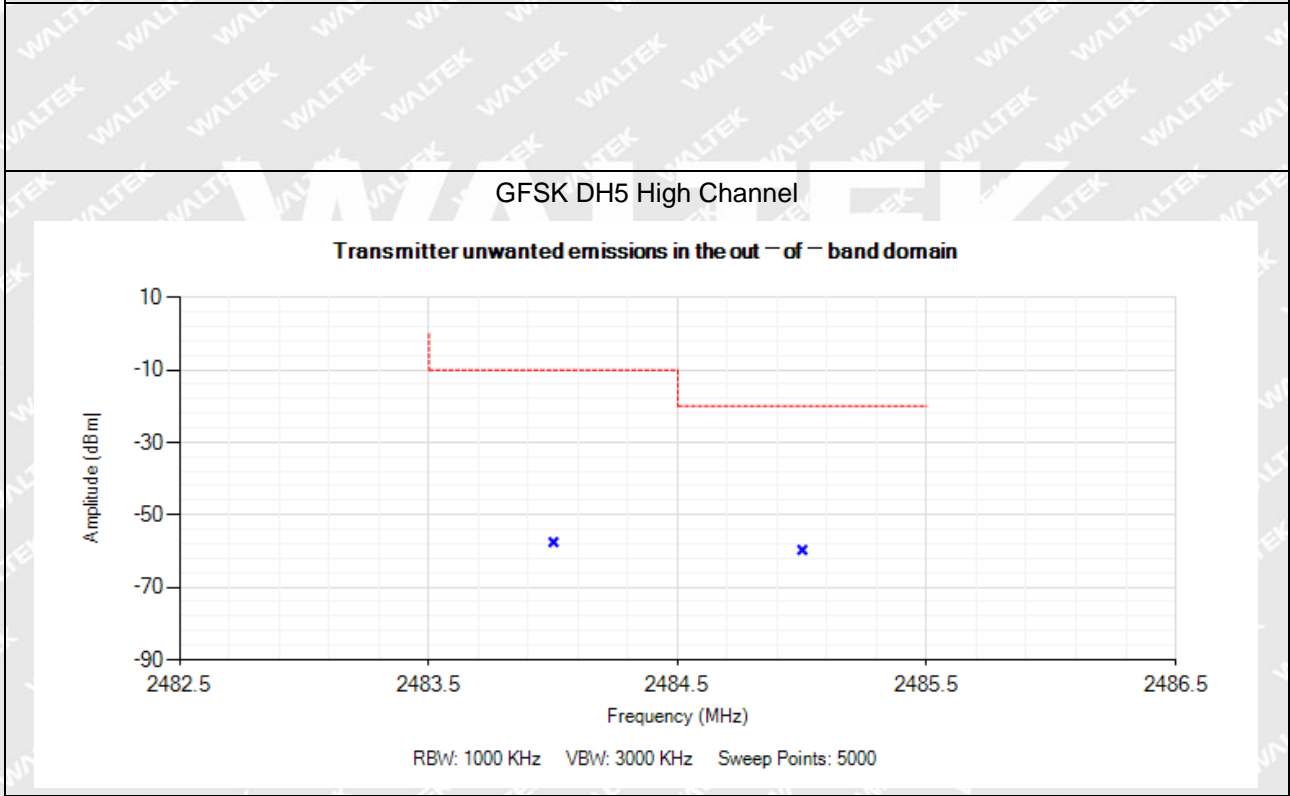
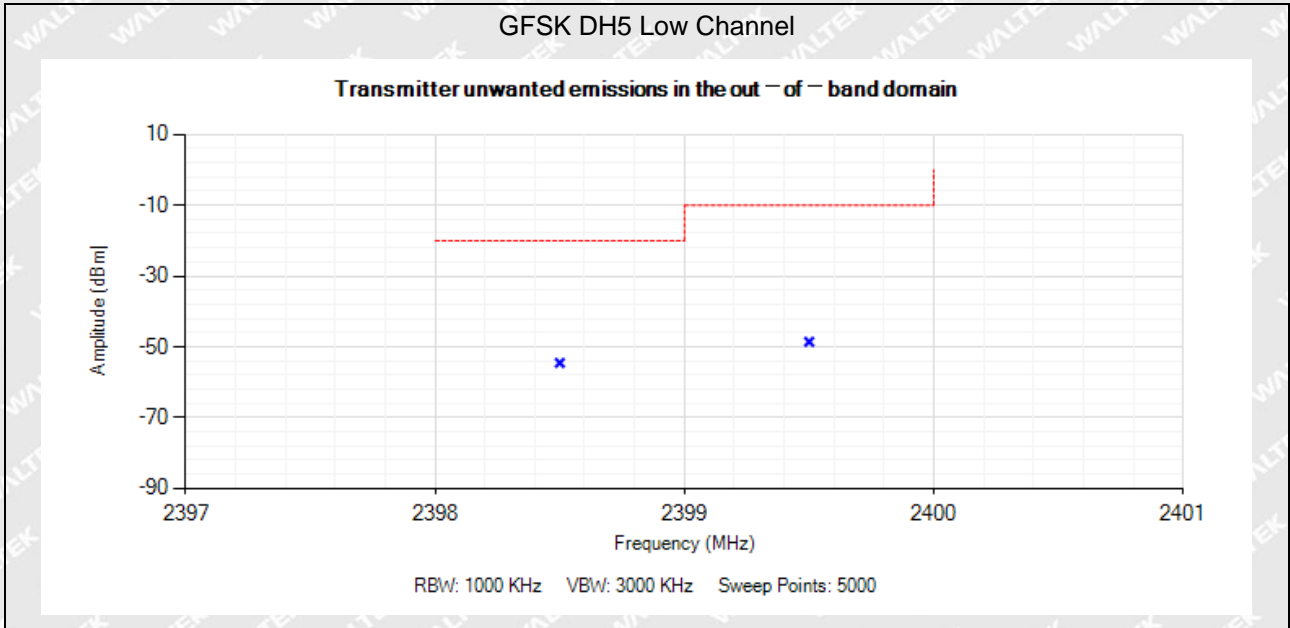

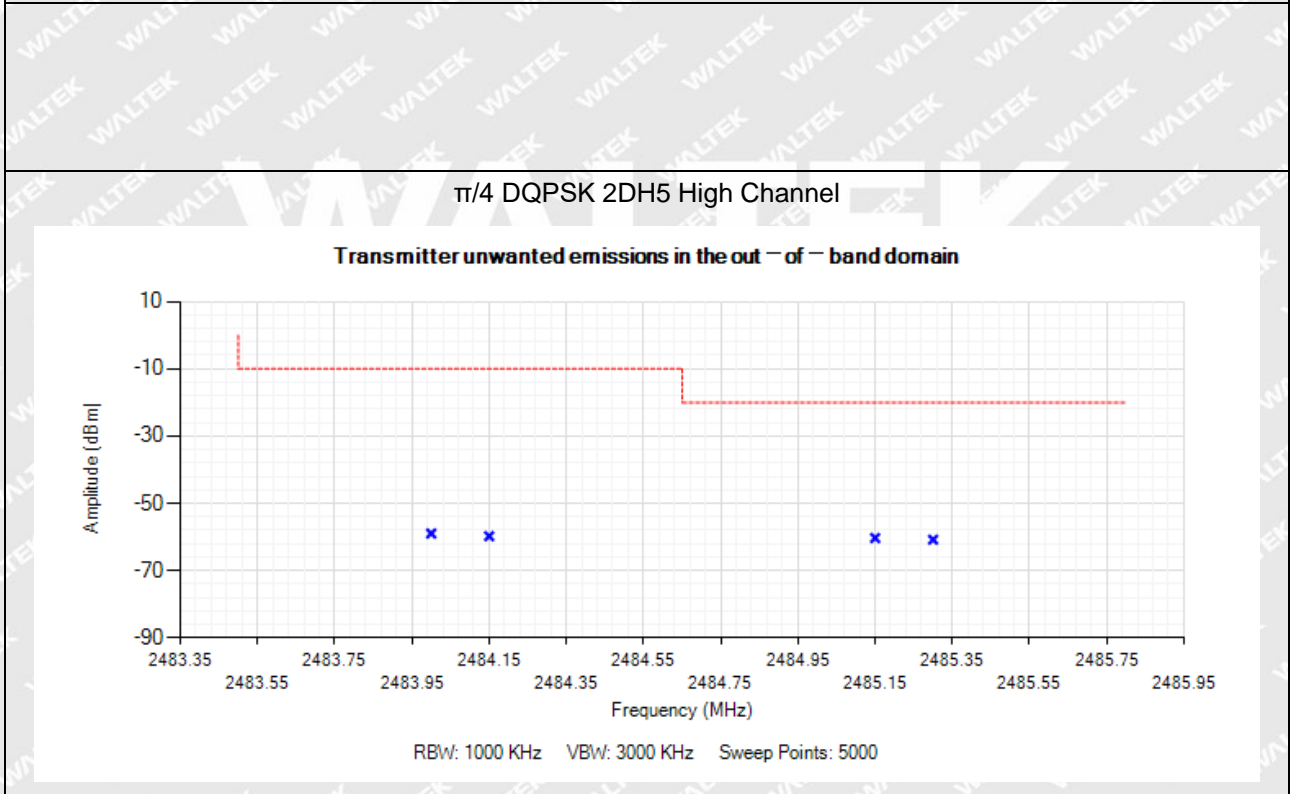
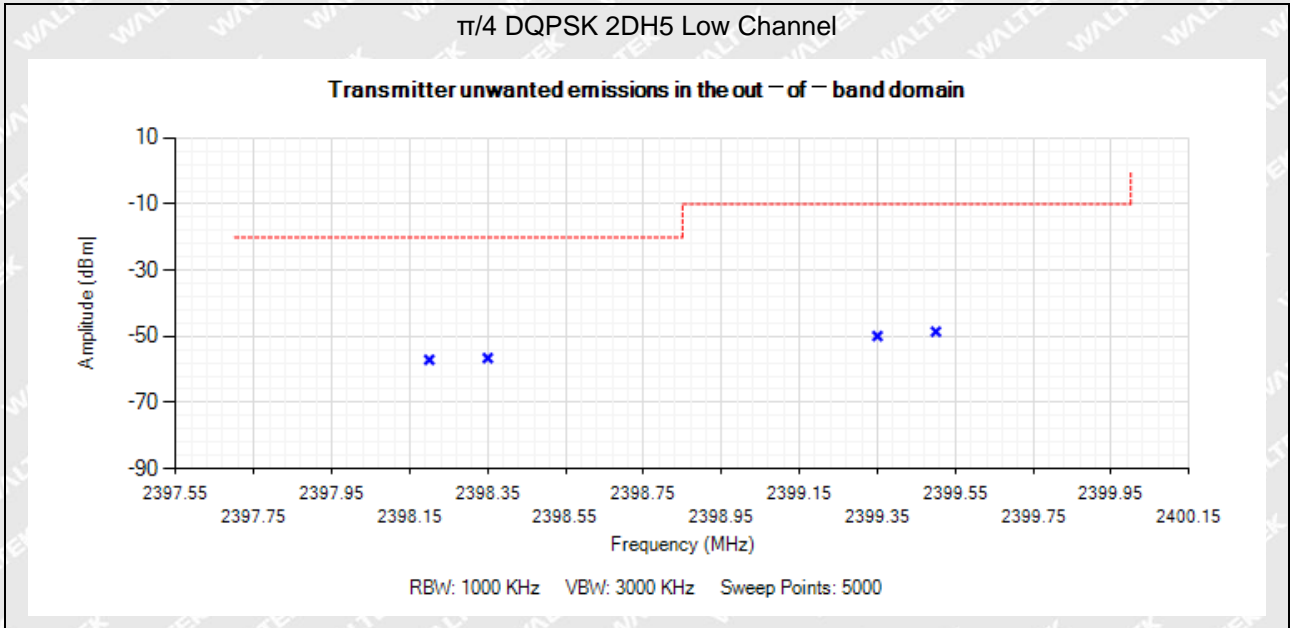



8DPSK 3DH5 Low Channel

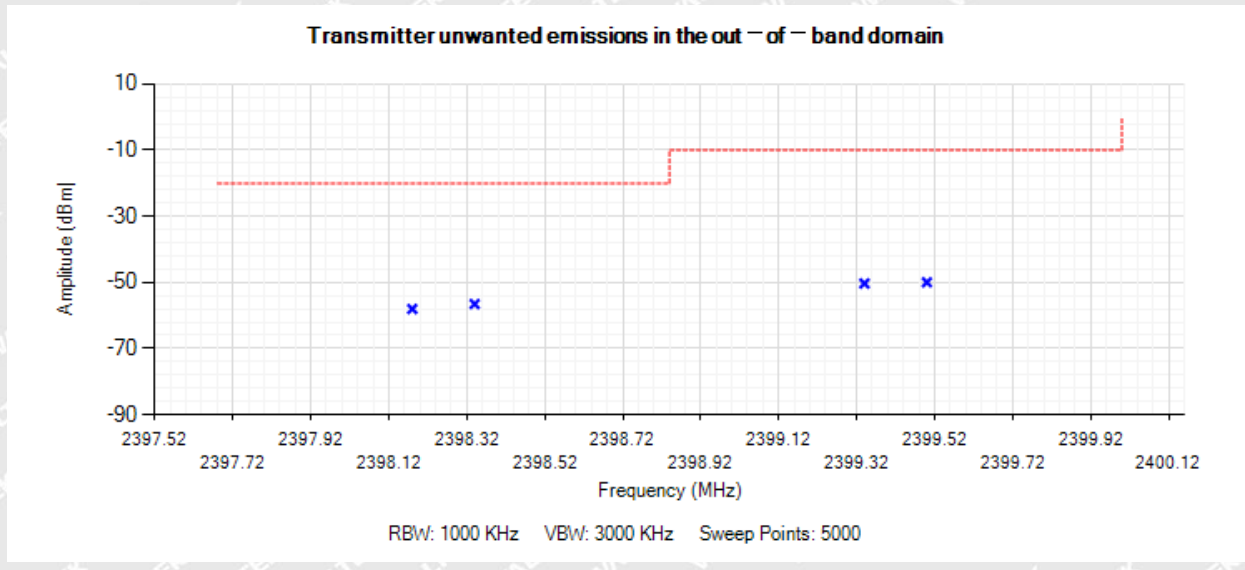

8DPSK 3DH5 High Channel

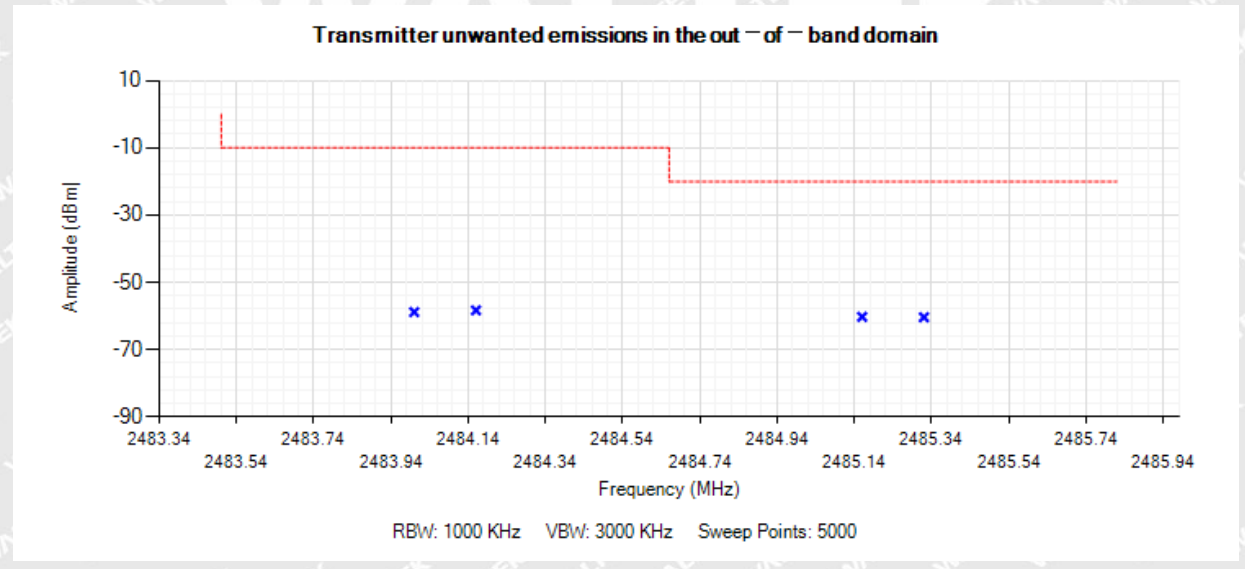



8. Transmitter Unwanted Emissions in the Spurious Domain

8.1 Standard Applicable

According to section 4.3.1.10.3& 4.3.2.9.3, the transmitter unwanted emissions in the spurious domain shall not exceed the values given in the following table.

Transmitter limit for spurious emissions

| Frequency range | Maximum power | Bandwidth |
|-------------------|---------------|-----------|
| 30MHz to 47MHz | -36dBm | 100kHz |
| 47MHz to 74MHz | -54dBm | 100kHz |
| 74MHz to 87.5MHz | -36dBm | 100kHz |
| 87.5MHz to 118MHz | -54dBm | 100kHz |
| 118MHz to 174MHz | -36dBm | 100kHz |
| 174MHz to 230MHz | -54dBm | 100kHz |
| 230MHz to 470MHz | -36dBm | 100kHz |
| 470MHz to 694MHz | -54dBm | 100kHz |
| 694MHz to 1GHz | -36dBm | 100kHz |
| 1GHz to 12.75GHz | -30dBm | 1MHz |

8.2 Test Procedure

The device under test has an integral antenna and the radiated measurement shall apply to the device, using the method of measurement as described in the EN300328 section 5.4.9.2

RBW=100kHz VBW=300kHz 30MHz-1GHz
 RBW=1MHz VBW=3MHz 1GHz-12.75GHz

8.3 Summary of Test Results/Plots

According to the data, the EUT complied with the EN 300328 standards, and had the worst cases:



➤ Spurious Emission From 30MHz To 1GHz
For EDR

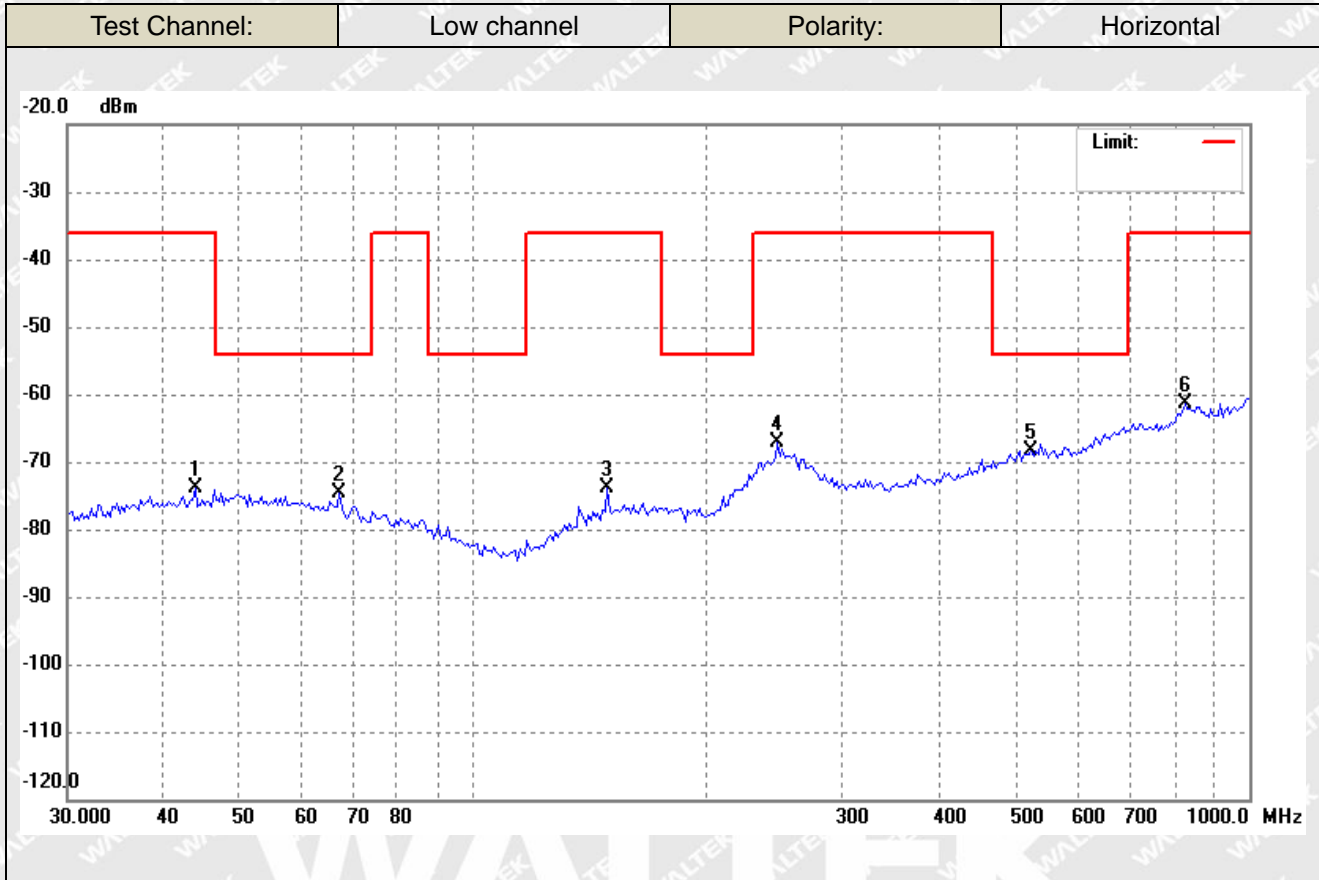

| No. | Frequency (MHz) | Reading (dBm) | Correct Factor(dB) | Result (dBm) | Limit (dBm) | Margin (dB) | Remark |
|-----|-----------------|---------------|--------------------|--------------|-------------|-------------|--------|
| 1 | 43.8452 | -76.81 | 2.92 | -73.89 | -36.00 | -37.89 | ERP |
| 2 | 67.3109 | -76.10 | 1.40 | -74.70 | -54.00 | -20.70 | ERP |
| 3 | 148.9175 | -74.58 | 0.75 | -73.83 | -36.00 | -37.83 | ERP |
| 4 | 246.9901 | -75.25 | 8.03 | -67.22 | -36.00 | -31.22 | ERP |
| 5 | 523.8763 | -75.81 | 7.50 | -68.31 | -54.00 | -14.31 | ERP |
| 6 | 827.1795 | -74.71 | 13.24 | -61.47 | -36.00 | -25.47 | ERP |

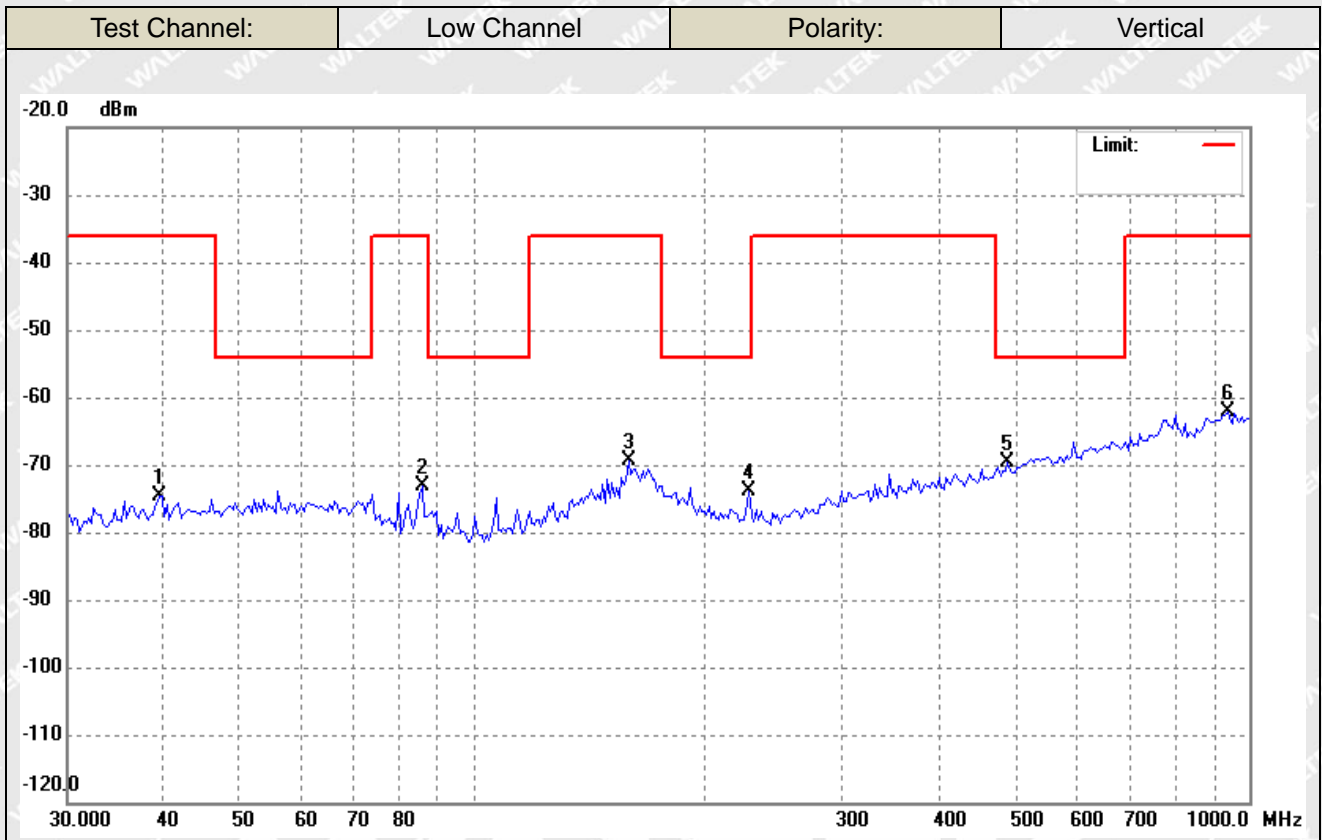

| No. | Frequency (MHz) | Reading (dBm) | Correct Factor(dB) | Result (dBm) | Limit (dBm) | Margin (dB) | Remark |
|-----|-----------------|---------------|--------------------|--------------|-------------|-------------|--------|
| 1 | 39.4588 | -77.00 | 2.50 | -74.50 | -36.00 | -38.50 | ERP |
| 2 | 86.0796 | -72.00 | -1.23 | -73.23 | -36.00 | -37.23 | ERP |
| 3 | 158.6399 | -76.87 | 7.39 | -69.48 | -36.00 | -33.48 | ERP |
| 4 | 227.0164 | -74.78 | 1.03 | -73.75 | -54.00 | -19.75 | ERP |
| 5 | 488.3263 | -76.67 | 6.96 | -69.71 | -54.00 | -15.71 | ERP |
| 6 | 938.7139 | -74.68 | 12.54 | -62.14 | -36.00 | -26.14 | ERP |

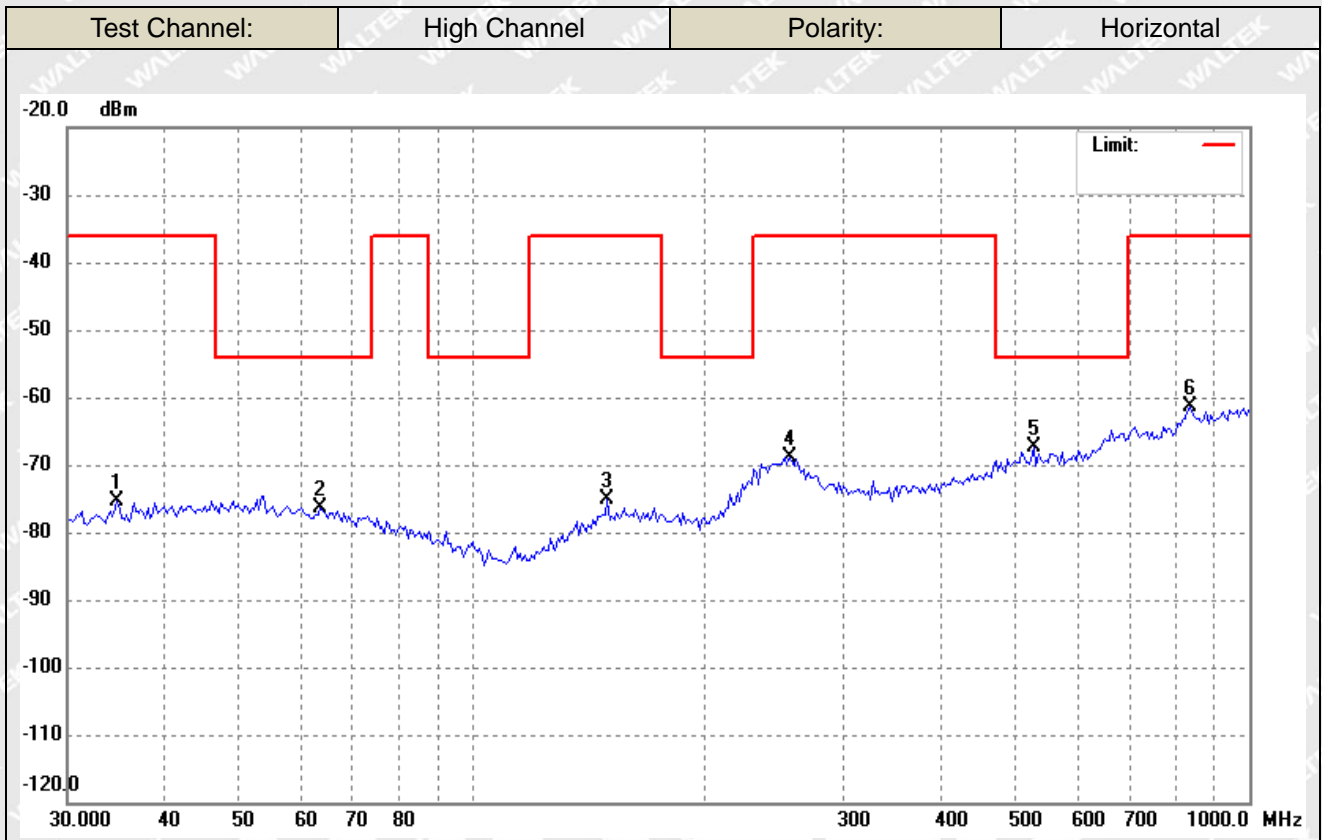

| No. | Frequency (MHz) | Reading (dBm) | Correct Factor(dB) | Result (dBm) | Limit (dBm) | Margin (dB) | Remark |
|-----|--------------------|------------------|-----------------------|-----------------|----------------|----------------|--------|
| 1 | 34.7705 | -77.49 | 2.05 | -75.44 | -36.00 | -39.44 | ERP |
| 2 | 63.6312 | -78.25 | 1.84 | -76.41 | -54.00 | -22.41 | ERP |
| 3 | 148.9175 | -75.84 | 0.75 | -75.09 | -36.00 | -39.09 | ERP |
| 4 | 255.8226 | -76.86 | 8.07 | -68.79 | -36.00 | -32.79 | ERP |
| 5 | 527.5707 | -74.85 | 7.54 | -67.31 | -54.00 | -13.31 | ERP |
| 6 | 838.8870 | -74.99 | 13.50 | -61.49 | -36.00 | -25.49 | ERP |

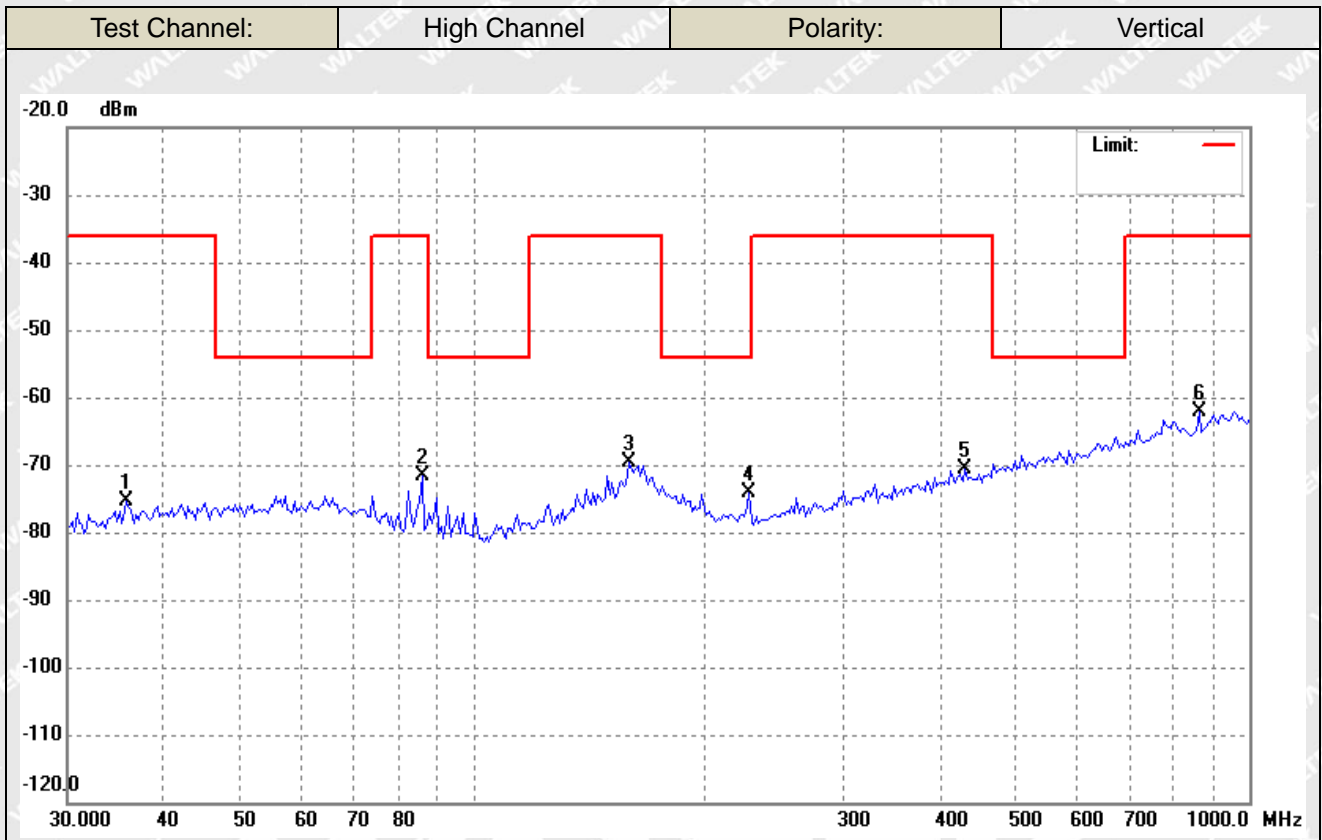

| No. | Frequency (MHz) | Reading (dBm) | Correct Factor(dB) | Result (dBm) | Limit (dBm) | Margin (dB) | Remark |
|-----|-----------------|---------------|--------------------|--------------|-------------|-------------|--------|
| 1 | 35.7617 | -77.43 | 2.15 | -75.28 | -36.00 | -39.28 | ERP |
| 2 | 86.0796 | -70.46 | -1.23 | -71.69 | -36.00 | -35.69 | ERP |
| 3 | 158.6399 | -77.06 | 7.39 | -69.67 | -36.00 | -33.67 | ERP |
| 4 | 227.0164 | -75.03 | 1.03 | -74.00 | -54.00 | -20.00 | ERP |
| 5 | 430.3053 | -76.51 | 5.92 | -70.59 | -36.00 | -34.59 | ERP |
| 6 | 862.8015 | -73.83 | 11.77 | -62.06 | -36.00 | -26.06 | ERP |



➤ Spurious Emission Above 1GHz
For EDR

| Frequency (MHz) | Reading (dBm) | Correct dB | Result (dBm) | Limit (dBm) | Margin (dB) | Polar H/V |
|----------------------|------------------|---------------|-----------------|----------------|----------------|--------------|
| Low Channel-2402MHz | | | | | | |
| 4804 | -51.34 | 5.73 | -45.61 | -30 | -15.61 | H |
| 7206 | -57.37 | 10.17 | -47.20 | -30 | -17.20 | H |
| 4804 | -52.69 | 5.73 | -46.96 | -30 | -16.96 | V |
| 7206 | -55.47 | 10.17 | -45.30 | -30 | -15.30 | V |
| High Channel-2480MHz | | | | | | |
| 4960 | -57.10 | 6.04 | -51.06 | -30 | -21.06 | H |
| 7440 | -57.01 | 10.27 | -46.74 | -30 | -16.74 | H |
| 4960 | -55.82 | 6.04 | -49.78 | -30 | -19.78 | V |
| 7440 | -56.70 | 10.27 | -46.43 | -30 | -16.43 | V |

Note 1: Testing is carried out with frequency rang 30MHz to 12.75GHz, which above 4th Harmonics are attenuated more than 20dB below the permissible limits or the field strength is too small to be measured.

Note 2: this EUT was tested in 3 orthogonal positions and the worst case position data was reported.

WALTEK



➤ **Conducted Transmitter Spurious Emission:**

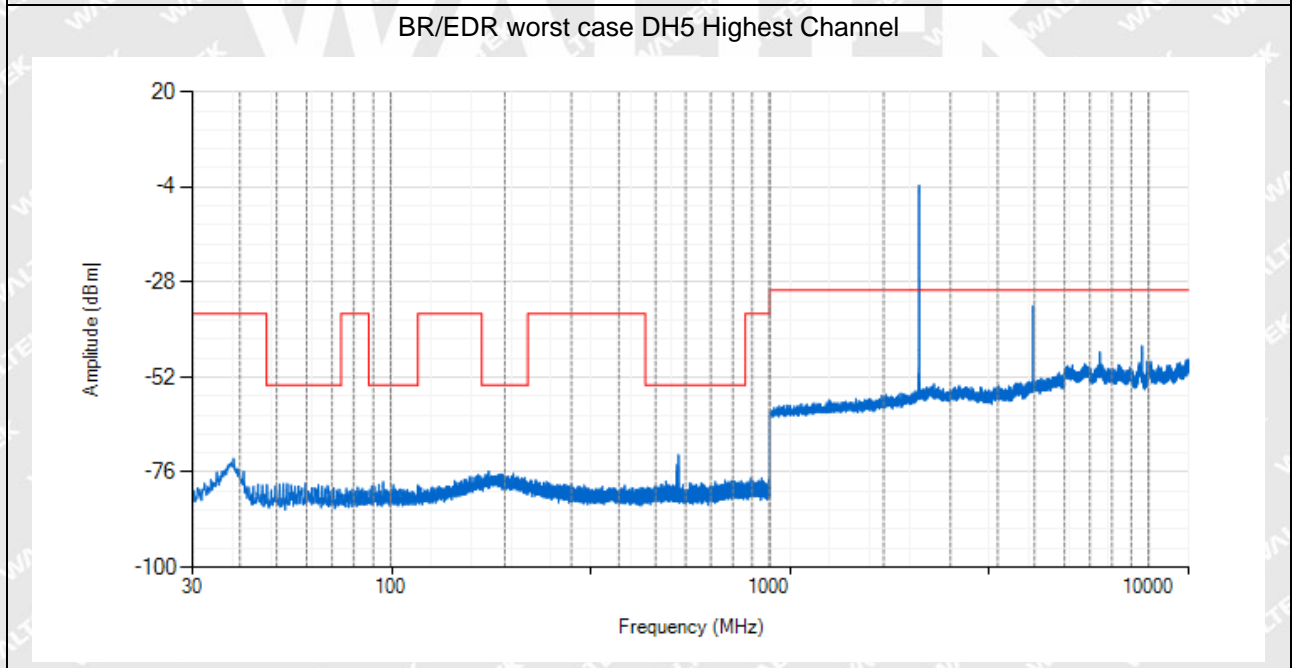
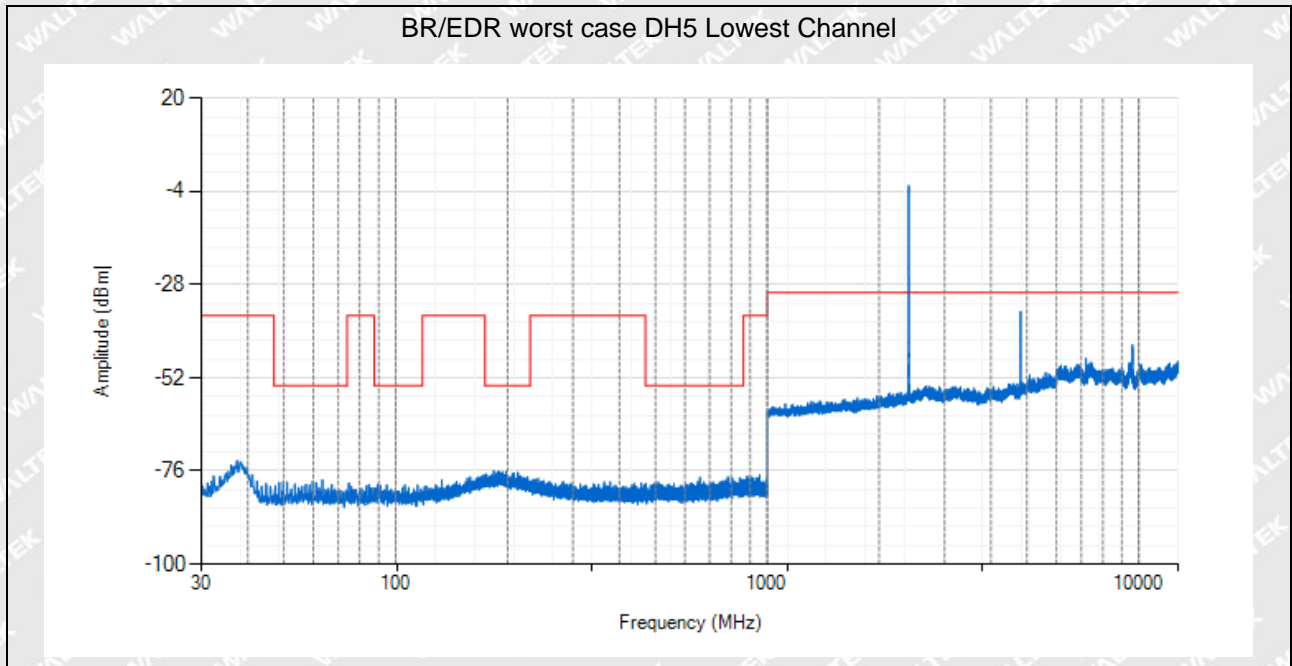

Note 1: Testing is carried out with frequency rang 30MHz to 12.75GHz, which emissions are too small are not list above. Test The worst case is DH5.



9. Receiver Spurious Emissions

9.1 Standard Applicable

According to section 4.3.1.11.3&4.3.2.10.3, the spurious emissions of the receiver shall not exceed the values given in table below:

NOTE: In case of equipment with antenna connectors, these limits apply to emissions at the antenna port (conducted) and to the emissions radiated by the cabinet. In case of integral antenna equipment (without temporary antenna connectors), these limits apply to emissions radiated by the equipment. Spurious emission limits for receivers

| Frequency range | Maximum power | Bandwidth |
|------------------|---------------|-----------|
| 30MHz to 1GHz | -57dBm | 100kHz |
| 1GHz to 12.75GHz | -47dBm | 1MHz |

9.2 Test Procedure

The device under test has an integral antenna and the radiated measurement shall apply to the device, using the method of measurement as described in the EN300328 section 5.4.10.2.

RBW=100kHz VBW=300kHz 30MHz-1GHz

RBW=1MHz VBW=3MHz 1GHz-12.75GHz

9.3 Summary of Test Results/Plots

According to the data, the EUT complied with the EN 300328 standards, and had the worst case:



➤ Receiver Spurious Emission From 30MHz To 1GHz

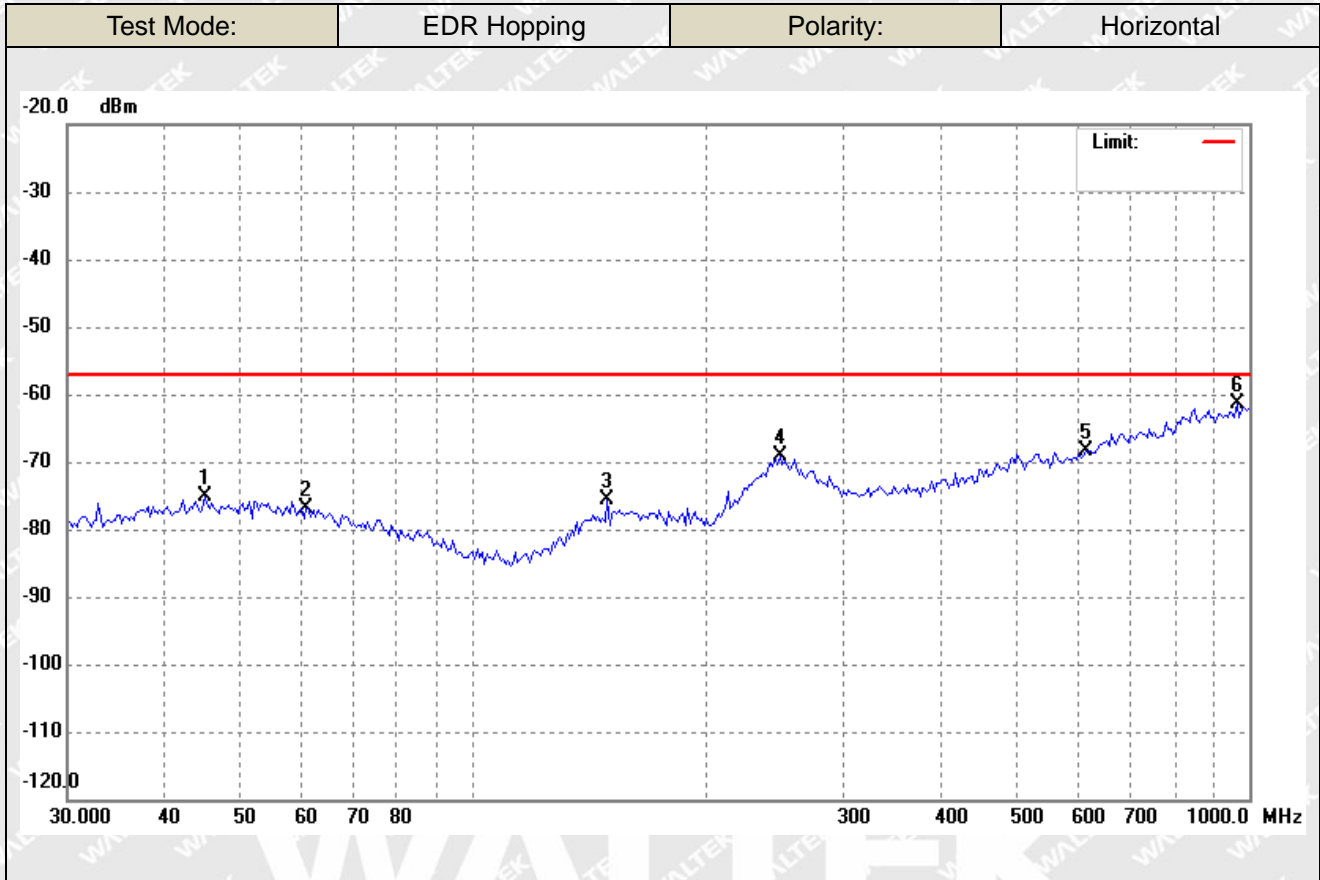

| No. | Frequency (MHz) | Reading (dBm) | Correct Factor(dB) | Result (dBm) | Limit (dBm) | Margin (dB) | Remark |
|-----|-----------------|---------------|--------------------|--------------|-------------|-------------|--------|
| 1 | 45.0951 | -78.09 | 3.03 | -75.06 | -57.00 | -18.06 | ERP |
| 2 | 61.0041 | -79.12 | 2.16 | -76.96 | -57.00 | -19.96 | ERP |
| 3 | 148.9175 | -76.30 | 0.75 | -75.55 | -57.00 | -18.55 | ERP |
| 4 | 248.7319 | -77.49 | 8.33 | -69.16 | -57.00 | -12.16 | ERP |
| 5 | 615.7743 | -77.10 | 8.63 | -68.47 | -57.00 | -11.47 | ERP |
| 6 | 965.4742 | -75.01 | 13.76 | -61.25 | -57.00 | -4.25 | ERP |

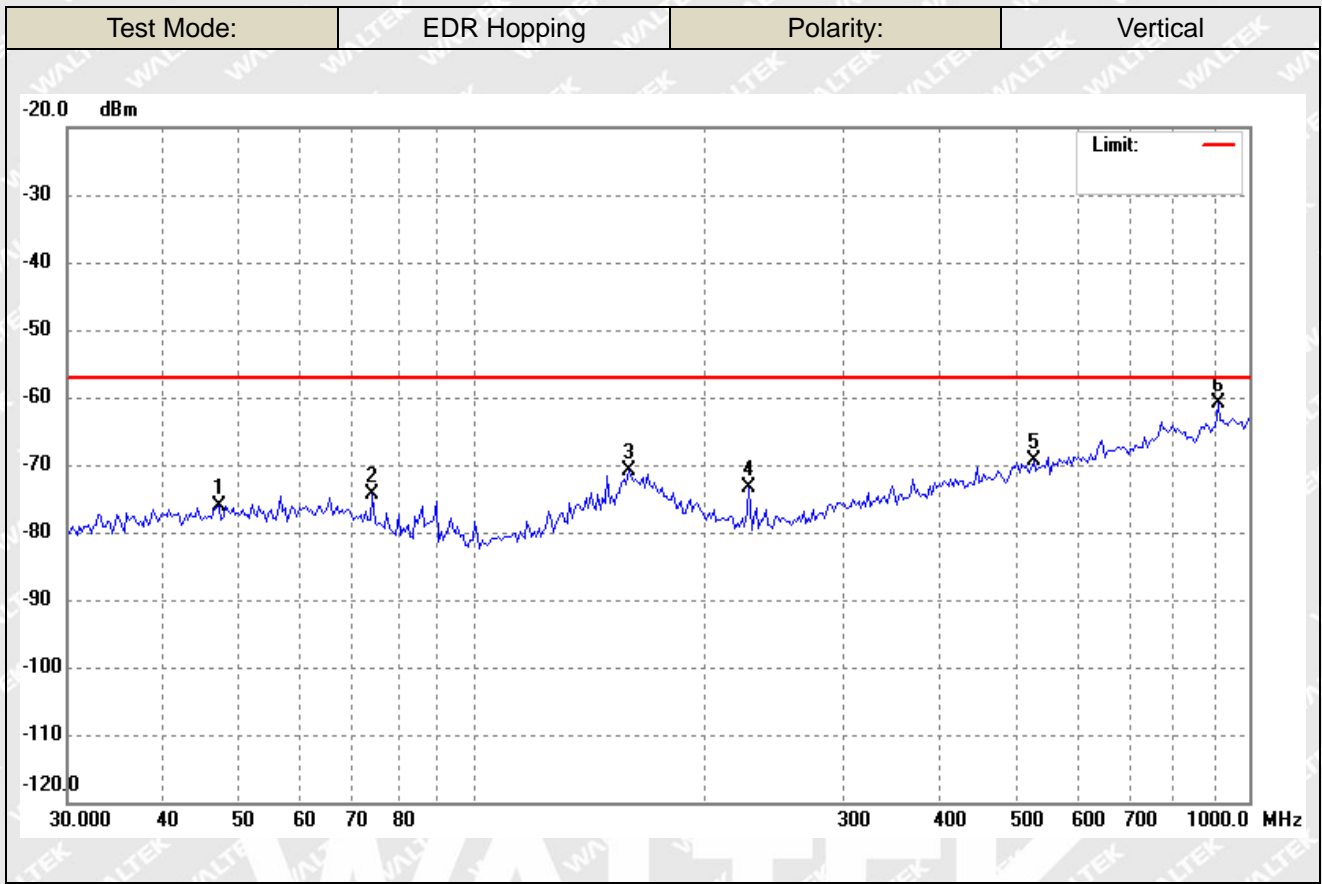

| No. | Frequency (MHz) | Reading (dBm) | Correct Factor(dB) | Result (dBm) | Limit (dBm) | Margin (dB) | Remark |
|-----|--------------------|------------------|-----------------------|-----------------|----------------|----------------|--------|
| 1 | 47.0371 | -79.22 | 3.22 | -76.00 | -57.00 | -19.00 | ERP |
| 2 | 74.2696 | -76.31 | 1.94 | -74.37 | -57.00 | -17.37 | ERP |
| 3 | 158.6399 | -78.35 | 7.39 | -70.96 | -57.00 | -13.96 | ERP |
| 4 | 227.0164 | -74.39 | 1.03 | -73.36 | -57.00 | -16.36 | ERP |
| 5 | 527.5707 | -77.06 | 7.63 | -69.43 | -57.00 | -12.43 | ERP |
| 6 | 912.6953 | -73.25 | 12.34 | -60.91 | -57.00 | -3.91 | ERP |



➤ Receiver Spurious Emission Above 1GHz
Hopping Mode

| Frequency (MHz) | Result (dBm) | Limit (dBm) | Margin (dB) | Polar H/V |
|--------------------|-----------------|----------------|----------------|--------------|
| 2685.24 | -59.53 | -47.00 | -12.53 | H |
| 6496.52 | -60.95 | -47.00 | -13.95 | H |
| 2671.49 | -59.69 | -47.00 | -12.69 | V |
| 6486.32 | -63.03 | -47.00 | -16.03 | V |

Note: Testing is carried out with frequency rang 30MHz to 12.75GHz, which above 1GHz are attenuated more than 20dB below the permissible limits or the field strength is too small to be measured.

WALTEK



Conducted Receiver Spurious Emission:

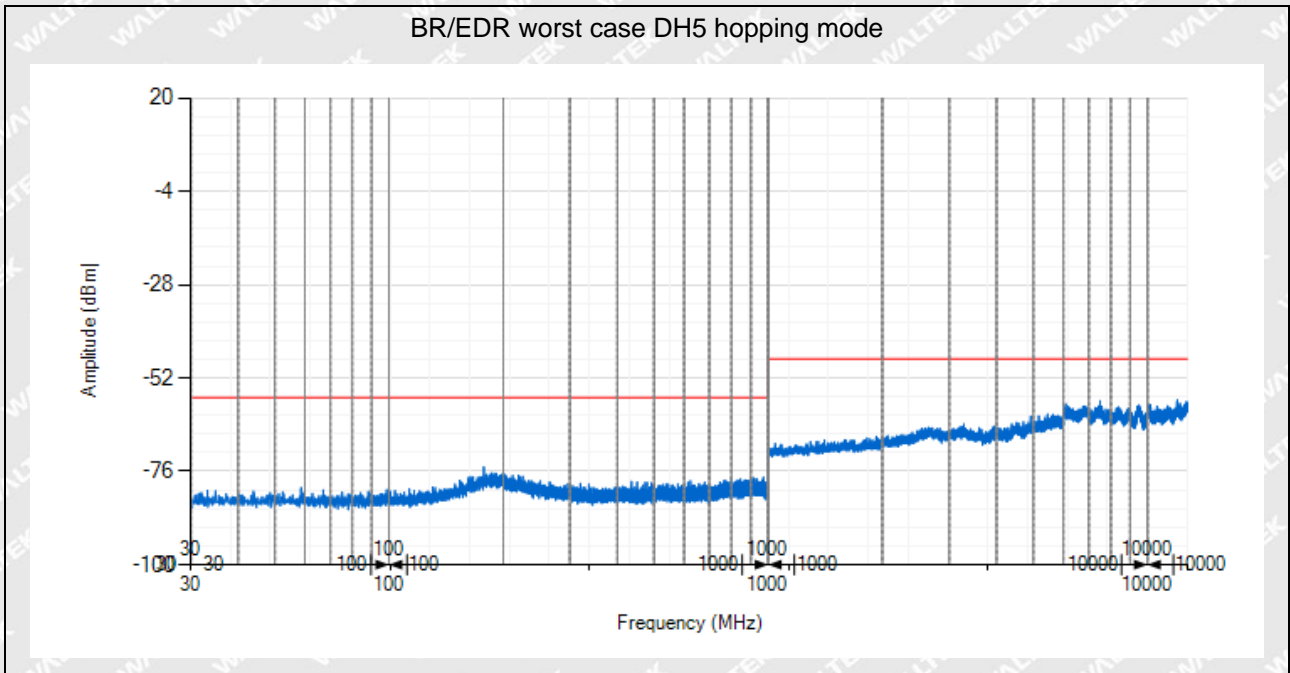

Note 1: Testing is carried out with frequency rang 30MHz to 12.75GHz, which emissions are too small are not list above.





10. Receiver Blocking

10.1 Standard Application

Receiver blocking is a measure of the ability of the equipment to receive a wanted signal on its operating channel without exceeding a given degradation due to the presence of an unwanted input signal (blocking signal) on frequencies other than those of the operating band and spurious responses.

Performance Criteria

For equipment that supports a PER or FER test to be performed, the minimum performance criterion shall be a PER or FER less than or equal to 10 %.

For equipment that does not support a PER or a FER test to be performed, the minimum performance criterion shall be no loss of the wireless transmission function needed for the intended use of the equipment.

The minimum performance criterion shall be a PER less than or equal to 10 %. The manufacturer may declare alternative performance criteria as long as that is appropriate for the intended use of the equipment (see clause 5.4.1.t)).

While maintaining the minimum performance criteria as defined in clause 4.3.1.12.3, the blocking levels at specified frequency offsets shall be equal to or greater than the limits defined for the applicable receiver category provided in table 6, table 7 or table 8.

Receiver category 1

Adaptive equipment with a maximum RF output power greater than 10 dBm e.i.r.p. shall be considered as receiver category 1 equipment.

Receiver category 2

non-adaptive equipment with a Medium Utilization (MU) factor greater than 1 % and less than or equal to 10 % (irrespective of the maximum RF output power); or equipment (adaptive or non-adaptive) with a maximum RF output power greater than 0 dBm e.i.r.p. and less than or equal to 10 dBm e.i.r.p.

Receiver category 3

non-adaptive equipment with a maximum Medium Utilization (MU) factor of 1 % (irrespective of the maximum RF output power); or equipment (adaptive or non-adaptive) with a maximum RF output power of 0 dBm e.i.r.p.



Table 6: Receiver Blocking parameters for Receiver Category 1 equipment

| Wanted signal mean power from companion device (dBm) (see notes 1 and 4) | Blocking signal frequency (MHz) | Blocking signal power (dBm) (see note 4) | Type of blocking signal |
|--|---------------------------------|--|-------------------------|
| (-133 dBm + 10 × log ₁₀ (OCBW)) or -68 dBm whichever is less (see note 2) | 2 380 | -34 | CW |
| | 2 504 | | |
| (-139 dBm + 10 × log ₁₀ (OCBW)) or -74 dBm whichever is less (see note 3) | 2 300 | | |
| | 2 330 | | |
| | 2 360 | | |
| | 2524 | | |
| | 2584 | | |
| | 2674 | | |

NOTE 1: OCBW is in Hz.

NOTE 2: In case of radiated measurements using a companion device and the level of the wanted signal from the companion device cannot be determined, a relative test may be performed using a wanted signal up to $P_{\min} + 26$ dB where P_{\min} is the minimum level of wanted signal required to meet the minimum performance criteria as defined in clause 4.3.1.12.3 in the absence of any blocking signal.

NOTE 3: In case of radiated measurements using a companion device and the level of the wanted signal from the companion device cannot be determined, a relative test may be performed using a wanted signal up to $P_{\min} + 20$ dB where P_{\min} is the minimum level of wanted signal required to meet the minimum performance criteria as defined in clause 4.3.1.12.3 in the absence of any blocking signal.

NOTE 4: The level specified is the level at the UUT receiver input assuming a 0 dBi antenna assembly gain. In case of conducted measurements, this level has to be corrected for the (in-band) antenna assembly gain (G). In case of radiated measurements, this level is equivalent to a power flux density (PFD) in front of the UUT antenna with the UUT being configured/positioned as recorded in clause 5.4.3.2.2.



Table 7: Receiver Blocking parameters receiver category 2 equipment

| Wanted signal mean power from companion device (dBm) (see notes 1 and 3) | Blocking signal frequency (MHz) | Blocking signal power (dBm) (see note 3) | Type of blocking signal |
|--|---------------------------------|--|-------------------------|
| $(-139 \text{ dBm} + 10 \times \log_{10}(\text{OCBW}) + 10 \text{ dB})$ or $(-74 \text{ dBm} + 10 \text{ dB})$ whichever is less (see note 2) | 2380 2504 2300 2584 | -34 | CW |
| NOTE 1: OCBW is in Hz. | | | |
| NOTE 2: In case of radiated measurements using a companion device and the level of the wanted signal from the companion device cannot be determined, a relative test may be performed using a wanted signal up to $P_{\min} + 26 \text{ dB}$ where P_{\min} is the minimum level of wanted signal required to meet the minimum performance criteria as defined in clause 4.3.1.12.3 in the absence of any blocking signal. | | | |
| NOTE 3: The level specified is the level at the UUT receiver input assuming a 0 dBi antenna assembly gain. In case of conducted measurements, this level has to be corrected for the (in-band) antenna assembly gain (G). In case of radiated measurements, this level is equivalent to a power flux density (PFD) in front of the UUT antenna with the UUT being configured/positioned as recorded in clause 5.4.3.2.2. | | | |

Table 8: Receiver Blocking parameters receiver category 3 equipment

| Wanted signal mean power from companion device (dBm) (see notes 1 and 3) | Blocking signal frequency (MHz) | Blocking signal power (dBm) (see note 3) | Type of blocking signal |
|--|---------------------------------|--|-------------------------|
| $(-139 \text{ dBm} + 10 \times \log_{10}(\text{OCBW}) + 20 \text{ dB})$ or $(-74 \text{ dBm} + 20 \text{ dB})$ whichever is less (see note 2) | 2380 2504 2300 2584 | -34 | CW |
| NOTE 1: OCBW is in Hz. | | | |
| NOTE 2: In case of radiated measurements using a companion device and the level of the wanted signal from the companion device cannot be determined, a relative test may be performed using a wanted signal up to $P_{\min} + 26 \text{ dB}$ where P_{\min} is the minimum level of wanted signal required to meet the minimum performance criteria as defined in clause 4.3.1.12.3 in the absence of any blocking signal. | | | |
| NOTE 3: The level specified is the level at the UUT receiver input assuming a 0 dBi antenna assembly gain. In case of conducted measurements, this level has to be corrected for the (in-band) antenna assembly gain (G). In case of radiated measurements, this level is equivalent to a power flux density (PFD) in front of the UUT antenna with the UUT being configured/positioned as recorded in clause 5.4.3.2.2. | | | |



10.2 Test Procedure

Step 1: • For non-frequency hopping equipment, the UUT shall be set to the lowest operating channel.

Step 2: • The blocking signal generator is set to the first frequency as defined in the appropriate table corresponding to the receiver category and type of equipment.

Step 3: • With the blocking signal generator switched off, a communication link is established between the UUT and the associated companion device using the test setup shown in figure 6. The variable attenuator is set to a value that achieves the minimum performance criteria as specified in clause 4.3.1.12.3 or clause 4.3.2.11.3 with a resolution of at least 1 dB. The resulting level for the wanted signal at the input of the UUT is P_{min} . This value shall be measured and recorded in the test report.

• The signal level is increased by the value provided in the table corresponding to the receiver category and type of equipment.

Step 4: • The blocking signal at the UUT is set to the level provided in the table corresponding to the receiver category and type of equipment. It shall be verified and recorded in the test report that the performance criteria as specified in clause 4.3.1.12.3 or clause 4.3.2.11.3 is met.

Step 5: • Repeat step 4 for each remaining combination of frequency and level for the blocking signal as provided in the table corresponding to the receiver category and type of equipment.

Step 6: • For non-frequency hopping equipment, repeat step 2 to step 5 with the UUT operating at the highest operating channel.

10.3 Test Setup

According to the section 5.4.11.2.1, the test block diagram shall be used.

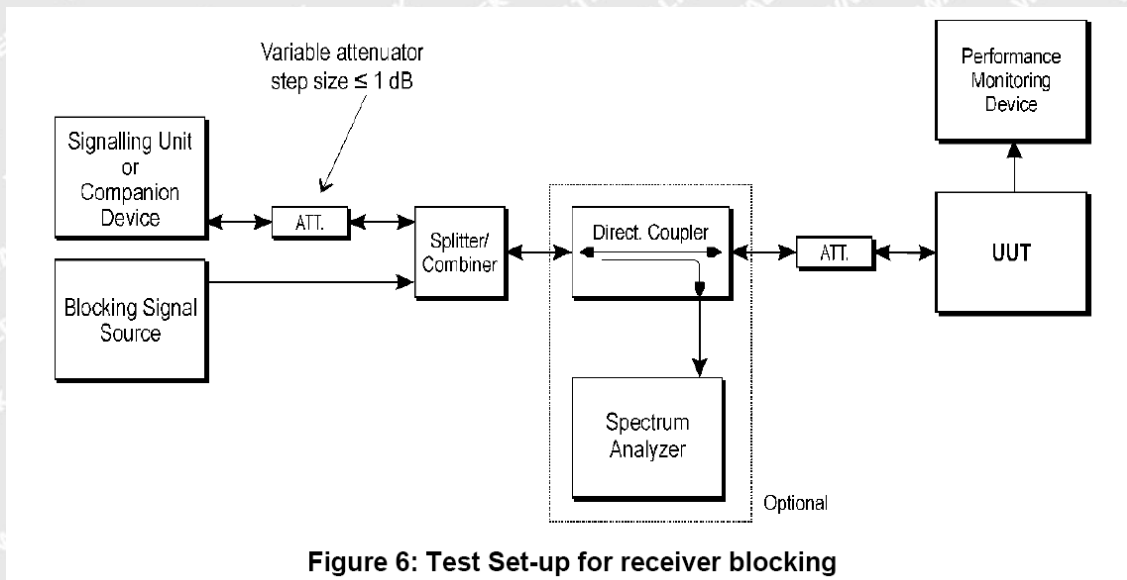

Figure 6: Test Set-up for receiver blocking

All test procedure is carried to the section 5.4.11.2.1
RBW/VBW=8MHz/30MHz



10.4 Summary of Test Results/Plots

➤ The product EDR is receiver category 3.

| Mode/ Channel | Wanted signal power (dBm) | Blocking signal Frequency (MHz) | Blocking signal power (dBm) | Test PER(%) | Limit(%) | Result |
|-----------------------|------------------------------------|---------------------------------------|--------------------------------------|-------------|----------|--------|
| GFSK-Hopping | -57.03 | 2380 | -31.33 | 0.10 | <10 | Pass |
| | | 2504 | | | | |
| | | 2300 | | | | |
| | | 2584 | | | | |
| π/4 DQPSK- Hopping | -55.72 | 2380 | -31.33 | 0.10 | <10 | Pass |
| | | 2504 | | | | |
| | | 2300 | | | | |
| | | 2584 | | | | |
| 8DPSK-Hopping | -55.68 | 2380 | -31.33 | 0.10 | <10 | Pass |
| | | 2504 | | | | |
| | | 2300 | | | | |
| | | 2584 | | | | |

*communication link is established between the UUT and the associated companion device using the test setup shown in figure 6. While the Companion device (CMW500) adjust to a level which can obtain the minimum performance criteria PER 10%, This level define to Pmin

Remark: the smallest channel bandwidth shall be used together with the lowest data rate for this channel bandwidth. This mode of operation are aligned with the performance criteria defined in clause 4.3.1.12.3 or clause 4.3.2.11.3 as declared by the manufacturer (see clause 5.4.1.t)).



EXHIBIT 1 - EUT PHOTOGRAPHS

Please refer to "ANNEX".

WALTEK

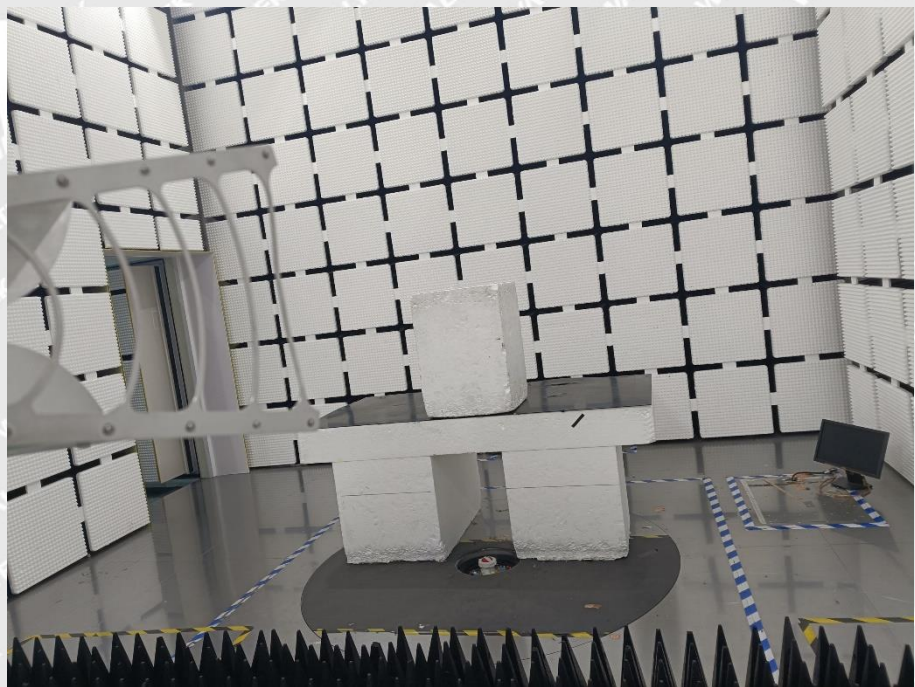

EXHIBIT 2 - Test setup photo

**Spurious Emission
Test Setup
(Below 1GHz)**



**Spurious Emission
Test Setup (Above
1GHz)**



***** END OF REPORT *****



TABLE OF CONTENTS

1. GENERAL INFORMATION.....4
1.1 PRODUCT DESCRIPTION FOR EQUIPMENT UNDER TEST (EUT).....4
1.2 COMPLIANCE STANDARDS5
1.3 TEST METHODOLOGY.....5
1.4 TEST FACILITY5
2. RF EXPOSURE BASIC RESTRICTIONS.....6
2.1 STANDARD APPLICABLE.....6
2.2 EVALUATION RESULTS.....6
EXHIBIT 1 - EUT PHOTOGRAPHS.....7

WALTEK



Report version

| Version No. | Date of issue | Description |
|-------------|---------------|-------------|
| Rev.00 | 2023-11-05 | Original |
| / | / | / |

WALTEK



1. GENERAL INFORMATION

1.1 Product Description for Equipment Under Test (EUT)

| General Description of EUT | |
|--|-----------------|
| Product Name: | ABS TWS earbuds |
| Trade Name: | / |
| Model No.: | MO2206 |
| Adding Model(s): | / |
| Rated Voltage: | DC3.7V |
| Battery Capacity: | 30mAh |
| Power Adaptor Model: | / |
| Software Version: | / |
| Hardware Version: | / |
| <i>Note: The test data is gathered from a production sample, provided by the manufacturer.</i> | |

| Technical Characteristics of EUT | |
|---|----------------------------|
| Bluetooth | |
| Bluetooth Version: | Bluetooth V5.3(EDR Mode) |
| Frequency Range: | 2402-2480MHz |
| Max.RF Output Power: | -1.63dBm (EIRP) |
| Type of Modulation: | GFSK, $\pi/4$ DQPSK, 8DPSK |
| Data Rate: | 1Mbps, 2Mbps, 3Mbps |
| Quantity of Channels | 79 |
| Channel Separation: | 1MHz |
| Type of Antenna: | Multilayer Chip Antenna |
| Antenna Gain: | 2.67dBi |
| <i>Note: The Antenna Gain is provided by the customer and can affect the validity of results.</i> | |



1.2 Compliance Standards

The tests were performed according to following standards:

EN 50663:2017: Generic standard for assessment of low power electronic and electrical equipment related to human exposure to electromagnetic fields (10MHz to 300GHz).

EN 62479:2010: Assessment of the compliance of low power electronic and electrical equipment with the basic restrictions related to human exposure to electromagnetic fields (10MHz to 300GHz).

Maintenance of compliance is the responsibility of the manufacturer. Any modification of the product maybe which result in lowering the emission/immunity should be checked to ensure compliance has been maintained.

1.3 Test Methodology

All measurements contained in this report were conducted with EN 50663, The equipment under test (EUT) was configured to measure its highest possible emission level. For more detail refer to the Operating Instructions.

1.4 Test Facility

Address of the test laboratory

Laboratory: Waltek Testing Group (Shenzhen) Co., Ltd.

Address: 1/F., Room 101, Building 1, Hongwei Industrial Park, Liuxian 2nd Road, Block 70 Bao'an District, Shenzhen, Guangdong, China

FCC – Registration No.: 125990

Waltek Testing Group (Shenzhen) Co., Ltd. EMC Laboratory has been registered and fully described in a report filed with the FCC (Federal Communications Commission). The acceptance letter from the FCC is maintained in our files. The Designation Number is CN5010, and Test Firm Registration Number is 125990.

Industry Canada (IC) Registration No.: 11464A

The 3m Semi-anechoic chamber of Waltek Testing Group (Shenzhen) Co., Ltd. has been registered by Certification and Engineering Bureau of Industry Canada for radio equipment testing with Registration No.: 11464A.



2. RF EXPOSURE BASIC RESTRICTIONS

2.1 Standard Applicable

Equipment complying with the requirements for the general public is deemed to comply with the requirements for workers without further testing.

The conformity assessment to demonstrate equipment compliance shall be made according to EN 62479:2010, 4.1 and Clause 6.

If routes B, C or D of 4.1 of EN 62479:2010 are followed then the values of P_{max} , as described in 4.2 of EN 62479:2010 and given in Annex A of EN 62479:2010, shall be replaced by those in Table 1 below.

Table 1 — Values of P_{max}

| Exposure tier | Region of body | $P_{max}(mW)$ |
|----------------|----------------|---------------|
| General public | Head and trunk | 20 |
| | Limbs | 40 |
| Workers | Head and trunk | 100 |
| | Limbs | 200 |

2.2 Evaluation Results

Maximum Average Output Power

| Modulation/ Frequency (MHz) | ERP/EIRP | ERP/EIRP | Limit | Result |
|--------------------------------|----------|----------|-------|-----------|
| | dBm | mW | mW | Pass/Fail |
| BR/EDR | | | | |
| GFSK | -3.88 | 0.4093 | 20 | Pass |
| $\pi/4$ DQPSK | -2.54 | 0.5572 | 20 | Pass |
| 8DPSK | -1.63 | 0.6871 | 20 | Pass |

Since average output power at worse case is: 0.6871mW which cannot exceed the exempt condition, 20mW specified in EN 50663. Correspondence between this European standard and Article 3 of Directive 2014/53/EU [2014 OJ L153]



EXHIBIT 1 - EUT PHOTOGRAPHS

Please refer to "ANNEX".

***** END OF REPORT *****

WALTEK