



Test Report

Report No. : AGC16344240601-002

SAMPLE NAME : Li-ion Polymer Battery

MODEL NAME : 402030

APPLICANT :

STANDARD(S) : Please refer to the following page(s).

DATE OF ISSUE : Jun. 11, 2024

Attestation of Global Compliance (Shenzhen) Std & Tech Co., Ltd.



Any report having not been signed by authorized approver, or having been altered without authorization, or having not been stamped by the "Dedicated Testing/Inspection Stamp" is deemed to be invalid. Copying or excerpting portion of, or altering the content of the report is not permitted without the written authorization of AGC. The test results presented in the report apply only to the tested sample. Any objections to report issued by AGC should be submitted to AGC within 15days after the issuance of the test report. Further enquiry of validity or verification of the test report should be addressed to AGC by agc01@agccert.com.

Attestation of Global Compliance(Shenzhen)Co., Ltd
Attestation of Global Compliance(Shenzhen)Std & Tech Co., Ltd
Tel: +86-755 2523 4088 E-mail: agc@agccert.com Web: http://www.agccert.com/



Report No.: AGC16344240601-002

Applicant :
Address :
Test Site :

Report on the submitted sample(s) said to be:

Sample Name : Li-ion Polymer Battery
Model : 402030
Sample Received Date : Jun. 05, 2024
Testing Period : Jun. 05, 2024 to Jun. 07, 2024
Test Requested : Selected test(s) as requested by client.

Test Requested:

European Regulation (EU) 2023/1542
- Lead, Cadmium and Mercury Content

Conclusion

Pass

Approved by: *Leon*

Suhongliang, Leon

Technical Director

Any report having not been signed by authorized approver, or having been altered without authorization, or having not been stamped by the "Dedicated Testing/Inspection Stamp" is deemed to be invalid. Copying or excerpting portion of, or altering the content of the report is not permitted without the written authorization of AGC. The test results presented in the report apply only to the tested sample. Any objections to report issued by AGC should be submitted to AGC within 15days after the issuance of the test report. Further enquiry of validity or verification of the test report should be addressed to AGC by agc01@agccert.com.

Attestation of Global Compliance(Shenzhen)Co., Ltd
Attestation of Global Compliance(Shenzhen)Std & Tech Co., Ltd
Tel: +86-755 2523 4088 E-mail: agc@agccert.com Web: http://www.agccert.com/



Report No.: AGC16344240601-002

Report Revise Record

Report Version	Issued Date	Valid Version	Notes
/	Jun. 11, 2024	Valid	Initial release

Any report having not been signed by authorized approver, or having been altered without authorization, or having not been stamped by the "Dedicated Testing/Inspection Stamp" is deemed to be invalid. Copying or excerpting portion of, or altering the content of the report is not permitted without the written authorization of AGC. The test results presented in the report apply only to the tested sample. Any objections to report issued by AGC should be submitted to AGC within 15days after the issuance of the test report. Further enquiry of validity or verification of the test report should be addressed to AGC by agc01@agccert.com.

Attestation of Global Compliance(Shenzhen)Co., Ltd
Attestation of Global Compliance(Shenzhen)Std & Tech Co., Ltd
Tel: +86-755 2523 4088 E-mail: agc@agccert.com Web: <http://www.agccert.com/>

Page 3 of 6



Report No.: AGC16344240601-002

The photo of the sample

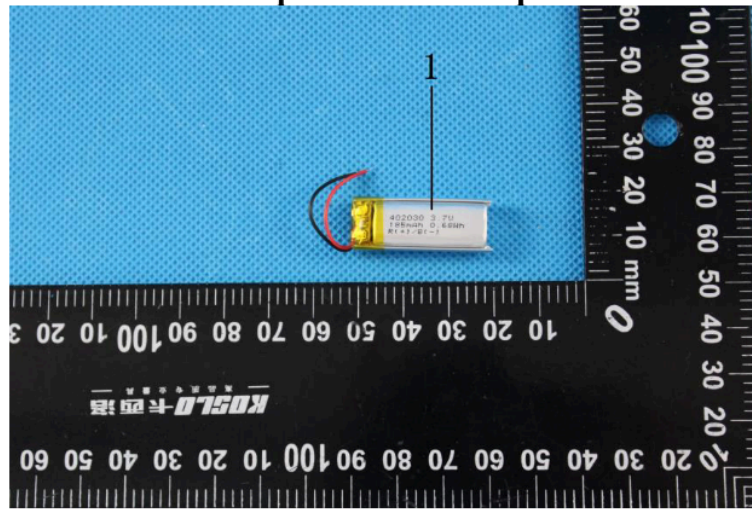

The photo of AGC16344240601-002 is for use only with the original report.

Test Point Description

Test point	Test point description
1	Battery

Any report having not been signed by authorized approver, or having been altered without authorization, or having not been stamped by the "Dedicated Testing/Inspection Stamp" is deemed to be invalid. Copying or excerpting portion of, or altering the content of the report is not permitted without the written authorization of AGC. The test results presented in the report apply only to the tested sample. Any objections to report issued by AGC should be submitted to AGC within 15days after the issuance of the test report. Further enquiry of validity or verification of the test report should be addressed to AGC by agc01@agccert.com.

Attestation of Global Compliance(Shenzhen)Co., Ltd
Attestation of Global Compliance(Shenzhen)Std & Tech Co., Ltd
Tel: +86-755 2523 4088 E-mail: agc@agccert.com Web: http://www.agccert.com/



Test Results:

Note: N.D.=Not Detected (less than method detection limit), MDL = Method Detection Limit, 1mg/kg=0.0001%

**European Regulation (EU) 2023/1542
- Lead, Cadmium and Mercury Content**

Test Methods and Equipment: IEC 62321-4:2013+A1:2017, IEC 62321-5:2013; ICP-OES

Test Item(s)	Unit	Limit	MDL	Test Result(s)
				1
Lead(Pb)	%	0.01	0.0005	N.D.
Cadmium(Cd)	%	0.002	0.0005	N.D.
Mercury(Hg)	%	0.0005	0.0001	N.D.
Conclusion				Conformity

Test Flow Chart of Lead, Cadmium and Mercury

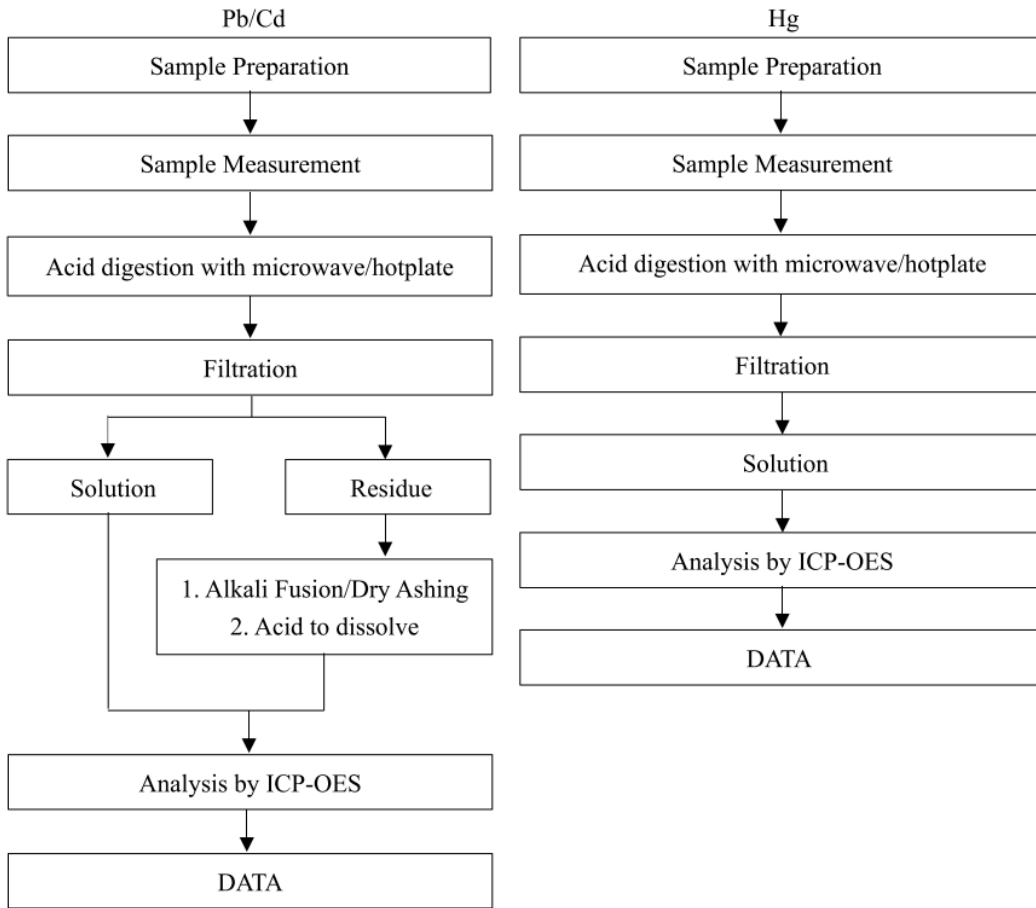

Any report having not been signed by authorized approver, or having been altered without authorization, or having not been stamped by the "Dedicated Testing/Inspection Stamp" is deemed to be invalid. Copying or excerpting portion of, or altering the content of the report is not permitted without the written authorization of AGC. The test results presented in the report apply only to the tested sample. Any objections to report issued by AGC should be submitted to AGC within 15days after the issuance of the test report. Further enquiry of validity or verification of the test report should be addressed to AGC by agc01@agccert.com.

Attestation of Global Compliance(Shenzhen)Co., Ltd
Attestation of Global Compliance(Shenzhen)Std & Tech Co., Ltd
Tel: +86-755 2523 4088 E-mail: agc@agccert.com Web: http://www.agccert.com/



Report No.: AGC16344240601-002

Conditions of Issuance of Test Reports

1. All samples and goods are accepted by the Attestation of Global Compliance (Shenzhen) Std & Tech Co., Ltd. (the "Company") solely for testing and reporting in accordance with the following terms and conditions. The company provides its services on the basis that such terms and conditions constitute express agreement between the company and any person, firm or company requesting its services (the "Clients").
2. Any report issued by Company as a result of this application for testing services (the "Report") shall be issued in confidence to the Clients and the Report will be strictly treated as such by the Company. It may not be reproduced either in its entirety or in part and it may not be used for advertising or other unauthorized purposes without the written consent of the Company. The Clients to whom the Report is issued may, however, show or send it, or a certified copy thereof prepared by the Company to its customer, supplier or other persons directly concerned. The Company will not, without the consent of the Clients, enter into any discussion or correspondence with any third party concerning the contents of the Report, unless required by the relevant governmental authorities, laws or court orders.
3. The Company shall not be called or be liable to be called to give evidence or testimony on the Report in a court of law without its prior written consent, unless required by the relevant governmental authorities, laws or court orders.
4. In the event of the improper use of the report as determined by the Company, the Company reserves the right to withdraw it, and to adopt any other additional remedies which may be appropriate.
5. Samples submitted for testing are accepted on the understanding that the Report issued cannot form the basis of, or be the instrument for, any legal action against the Company.
6. The Company will not be liable for or accept responsibility for any loss or damage however arising from the use of information contained in any of its Reports or in any communication whatsoever about its said tests or investigations.
7. Clients wishing to use the Report in court proceedings or arbitration shall inform the Company to that effect prior to submitting the sample for testing.
8. The Company is not responsible for recalling the electronic version of the original report when any revision is made to them. The Client assumes the responsibility to providing the revised version to any interested party who uses them.
9. Subject to the variable length of retention time for test data and report stored hereinto as otherwise specifically required by individual accreditation authorities, the Company will only keep the supporting test data and information of the test report for a period of six years. The data and information will be disposed of after the aforementioned retention period has elapsed. Under no circumstances shall we provide any data and information which has been disposed of after retention period. Under no circumstances shall we be liable for damage of any kind, including (but not limited to) compensatory damages, lost profits, lost data, or any form of special, incidental, indirect, consequential or punitive damages of any kind, whether based on breach of contract of warranty, tort (including negligence), product liability or otherwise, even if we are informed in advance of the possibility of such damages.

*** End of Report ***

Any report having not been signed by authorized approver, or having been altered without authorization, or having not been stamped by the "Dedicated Testing/Inspection Stamp" is deemed to be invalid. Copying or excerpting portion of, or altering the content of the report is not permitted without the written authorization of AGC. The test results presented in the report apply only to the tested sample. Any objections to report issued by AGC should be submitted to AGC within 15days after the issuance of the test report. Further enquiry of validity or verification of the test report should be addressed to AGC by agc01@agccert.com.

Attestation of Global Compliance(Shenzhen)Co., Ltd
Attestation of Global Compliance(Shenzhen)Std & Tech Co., Ltd
Tel: +86-755 2523 4088 E-mail: agc@agccert.com Web: <http://www.agccert.com/>

Page 6 of 6



Test Report

Report No. : AGC16344240601-001

SAMPLE NAME : Li-ion Polymer Battery

MODEL NAME : 450909

APPLICANT :

STANDARD(S) : Please refer to the following page(s).

DATE OF ISSUE : Jun. 11, 2024

Attestation of Global Compliance (Shenzhen) Std & Tech Co., Ltd.



Any report having not been signed by authorized approver, or having been altered without authorization, or having not been stamped by the "Dedicated Testing/Inspection Stamp" is deemed to be invalid. Copying or excerpting portion of, or altering the content of the report is not permitted without the written authorization of AGC. The test results presented in the report apply only to the tested sample. Any objections to report issued by AGC should be submitted to AGC within 15days after the issuance of the test report. Further enquiry of validity or verification of the test report should be addressed to AGC by agc01@agccert.com.

Attestation of Global Compliance(Shenzhen)Co., Ltd
Attestation of Global Compliance(Shenzhen)Std & Tech Co., Ltd
Tel: +86-755 2523 4088 E-mail: agc@agccert.com Web: http://www.agccert.com/



Report No.: AGC16344240601-001

Applicant :
Address :
Test Site :

Report on the submitted sample(s) said to be:

Sample Name : Li-ion Polymer Battery
Model : 450909
Sample Received Date : Jun. 05, 2024
Testing Period : Jun. 05, 2024 to Jun. 07, 2024
Test Requested : Selected test(s) as requested by client.

Test Requested:

European Regulation (EU) 2023/1542
- Lead, Cadmium and Mercury Content

Conclusion

Pass

Approved by: *Leon*

Suhongliang, Leon

Technical Director

Any report having not been signed by authorized approver, or having been altered without authorization, or having not been stamped by the "Dedicated Testing/Inspection Stamp" is deemed to be invalid. Copying or excerpting portion of, or altering the content of the report is not permitted without the written authorization of AGC. The test results presented in the report apply only to the tested sample. Any objections to report issued by AGC should be submitted to AGC within 15days after the issuance of the test report. Further enquiry of validity or verification of the test report should be addressed to AGC by agc01@agccert.com.

Attestation of Global Compliance(Shenzhen)Co., Ltd

Attestation of Global Compliance(Shenzhen)Std & Tech Co., Ltd

Tel: +86-755 2523 4088 E-mail: agc@agccert.com Web: <http://www.agccert.com/>

Page 2 of 6



Report No.: AGC16344240601-001

Report Revise Record

Report Version	Issued Date	Valid Version	Notes
/	Jun. 11, 2024	Valid	Initial release

Any report having not been signed by authorized approver, or having been altered without authorization, or having not been stamped by the "Dedicated Testing/Inspection Stamp" is deemed to be invalid. Copying or excerpting portion of, or altering the content of the report is not permitted without the written authorization of AGC. The test results presented in the report apply only to the tested sample. Any objections to report issued by AGC should be submitted to AGC within 15days after the issuance of the test report. Further enquiry of validity or verification of the test report should be addressed to AGC by agc01@agccert.com.

Attestation of Global Compliance(Shenzhen)Co., Ltd

Attestation of Global Compliance(Shenzhen)Std & Tech Co., Ltd

Tel: +86-755 2523 4088 E-mail: agc@agccert.com Web: <http://www.agccert.com/>

Page 3 of 6



Report No.: AGC16344240601-001

The photo of the sample

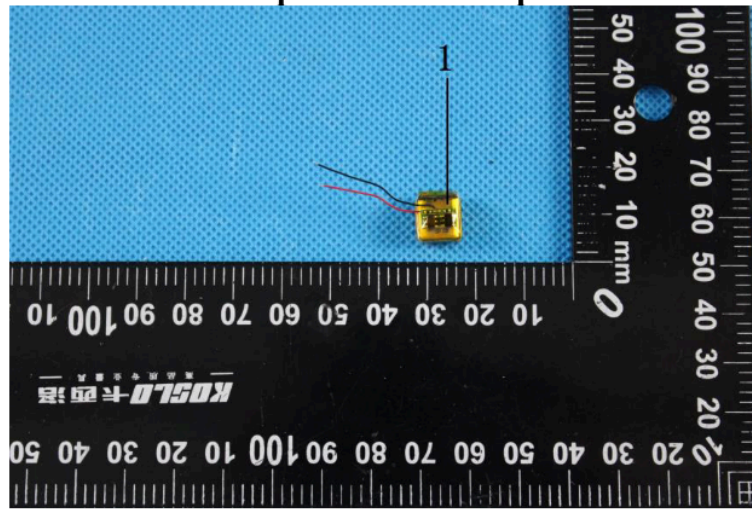

The photo of AGC16344240601-001 is for use only with the original report.

Test Point Description

Test point	Test point description
1	Battery

Any report having not been signed by authorized approver, or having been altered without authorization, or having not been stamped by the "Dedicated Testing/Inspection Stamp" is deemed to be invalid. Copying or excerpting portion of, or altering the content of the report is not permitted without the written authorization of AGC. The test results presented in the report apply only to the tested sample. Any objections to report issued by AGC should be submitted to AGC within 15days after the issuance of the test report. Further enquiry of validity or verification of the test report should be addressed to AGC by agc01@agccert.com.

Attestation of Global Compliance(Shenzhen)Co., Ltd
 Attestation of Global Compliance(Shenzhen)Std & Tech Co., Ltd
 Tel: +86-755 2523 4088 E-mail: agc@agccert.com Web: http://www.agccert.com/



Test Results:

Note: N.D.=Not Detected (less than method detection limit), MDL = Method Detection Limit, 1mg/kg=0.0001%

**European Regulation (EU) 2023/1542
- Lead, Cadmium and Mercury Content**

Test Methods and Equipment: IEC 62321-4:2013+A1:2017,IEC 62321-5:2013; ICP-OES

Test Item(s)	Unit	Limit	MDL	Test Result(s)
				1
Lead(Pb)	%	0.01	0.0005	N.D.
Cadmium(Cd)	%	0.002	0.0005	N.D.
Mercury(Hg)	%	0.0005	0.0001	N.D.
Conclusion				Conformity

Test Flow Chart of Lead, Cadmium and Mercury

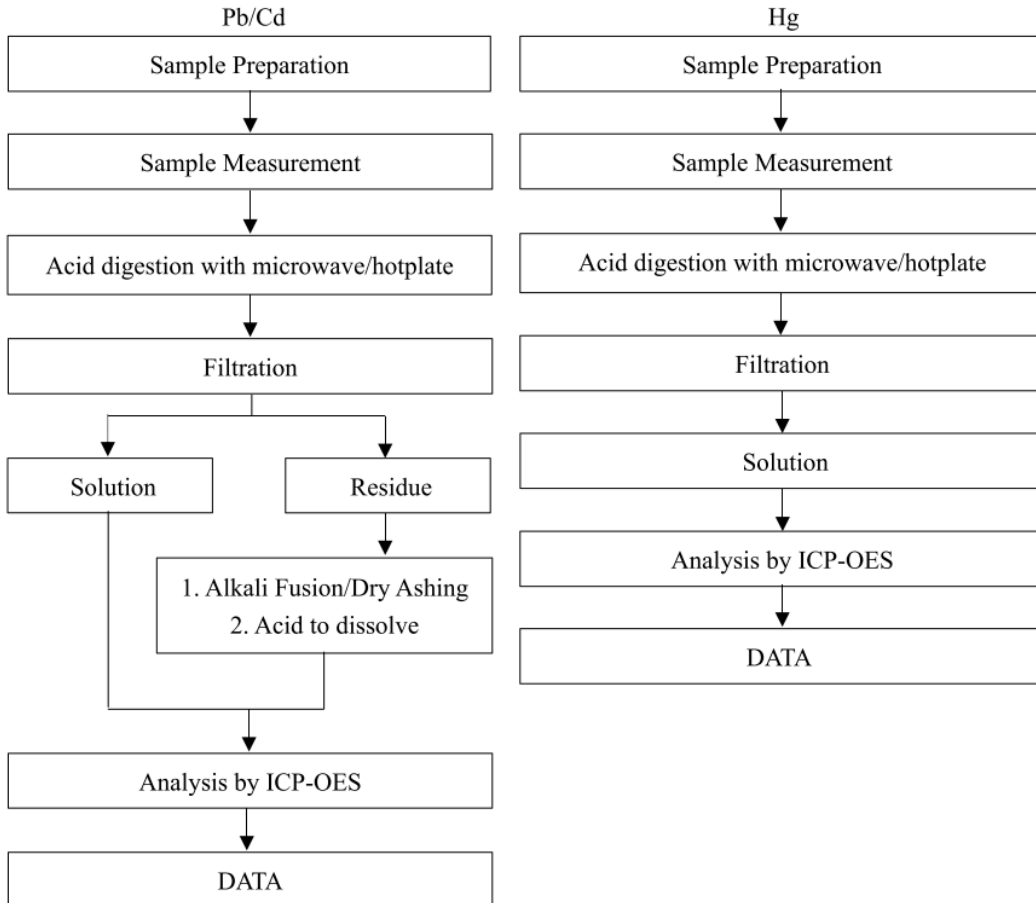

Any report having not been signed by authorized approver, or having been altered without authorization, or having not been stamped by the "Dedicated Testing/Inspection Stamp" is deemed to be invalid. Copying or excerpting portion of, or altering the content of the report is not permitted without the written authorization of AGC. The test results presented in the report apply only to the tested sample. Any objections to report issued by AGC should be submitted to AGC within 15days after the issuance of the test report. Further enquiry of validity or verification of the test report should be addressed to AGC by agc01@agccert.com.

Attestation of Global Compliance(Shenzhen)Co., Ltd
Attestation of Global Compliance(Shenzhen)Std & Tech Co., Ltd
Tel: +86-755 2523 4088 E-mail: agc@agccert.com Web: http://www.agccert.com/



Report No.: AGC16344240601-001

Conditions of Issuance of Test Reports

1. All samples and goods are accepted by the Attestation of Global Compliance (Shenzhen) Std & Tech Co., Ltd. (the "Company") solely for testing and reporting in accordance with the following terms and conditions. The company provides its services on the basis that such terms and conditions constitute express agreement between the company and any person, firm or company requesting its services (the "Clients").
2. Any report issued by Company as a result of this application for testing services (the "Report") shall be issued in confidence to the Clients and the Report will be strictly treated as such by the Company. It may not be reproduced either in its entirety or in part and it may not be used for advertising or other unauthorized purposes without the written consent of the Company. The Clients to whom the Report is issued may, however, show or send it, or a certified copy thereof prepared by the Company to its customer, supplier or other persons directly concerned. The Company will not, without the consent of the Clients, enter into any discussion or correspondence with any third party concerning the contents of the Report, unless required by the relevant governmental authorities, laws or court orders.
3. The Company shall not be called or be liable to be called to give evidence or testimony on the Report in a court of law without its prior written consent, unless required by the relevant governmental authorities, laws or court orders.
4. In the event of the improper use of the report as determined by the Company, the Company reserves the right to withdraw it, and to adopt any other additional remedies which may be appropriate.
5. Samples submitted for testing are accepted on the understanding that the Report issued cannot form the basis of, or be the instrument for, any legal action against the Company.
6. The Company will not be liable for or accept responsibility for any loss or damage however arising from the use of information contained in any of its Reports or in any communication whatsoever about its said tests or investigations.
7. Clients wishing to use the Report in court proceedings or arbitration shall inform the Company to that effect prior to submitting the sample for testing.
8. The Company is not responsible for recalling the electronic version of the original report when any revision is made to them. The Client assumes the responsibility to providing the revised version to any interested party who uses them.
9. Subject to the variable length of retention time for test data and report stored hereinto as otherwise specifically required by individual accreditation authorities, the Company will only keep the supporting test data and information of the test report for a period of six years. The data and information will be disposed of after the aforementioned retention period has elapsed. Under no circumstances shall we provide any data and information which has been disposed of after retention period. Under no circumstances shall we be liable for damage of any kind, including (but not limited to) compensatory damages, lost profits, lost data, or any form of special, incidental, indirect, consequential or punitive damages of any kind, whether based on breach of contract of warranty, tort (including negligence), product liability or otherwise, even if we are informed in advance of the possibility of such damages.

*** End of Report ***

Any report having not been signed by authorized approver, or having been altered without authorization, or having not been stamped by the "Dedicated Testing/Inspection Stamp" is deemed to be invalid. Copying or excerpting portion of, or altering the content of the report is not permitted without the written authorization of AGC. The test results presented in the report apply only to the tested sample. Any objections to report issued by AGC should be submitted to AGC within 15days after the issuance of the test report. Further enquiry of validity or verification of the test report should be addressed to AGC by agc01@agccert.com.

Attestation of Global Compliance(Shenzhen)Co., Ltd
Attestation of Global Compliance(Shenzhen)Std & Tech Co., Ltd
Tel: +86-755 2523 4088 E-mail: agc@agccert.com Web: <http://www.agccert.com/>

Page 6 of 6



中国认可
国际互认
检测
TESTING
CNAS L5138

TEST REPORT IEC 62133-2 Secondary cells and batteries containing alkaline or other non-acid electrolytes – Safety requirements for portable sealed secondary cells, and for batteries made from them, for use in portable applications –Part 2: Lithium systems	
Report Number.....:	TSZ23051136-P01-R01
Date of issue.....:	2023-05-10
Total number of pages.....:	24
Name of Testing Laboratory preparing the Report.....:	Shenzhen Tiansu Calibration and Testing Co., Ltd
Applicant's name.....:	
Address.....:	
Test specification:	
Standard.....:	IEC 62133-2:2017
General disclaimer:	
The test results presented in this report relate only to the object tested. This report shall not be reproduced, except in full, without the written approval of the Issuing Laboratory.	
Test item description.....:	Polymer Lithium-ion cell
Trade Mark.....:	N/A
Manufacturer.....:	Same as applicant
Model/Type reference.....:	GX 450909
Ratings.....:	3.7V,30mAh, 0.111Wh
Responsible Testing Laboratory and testing location(s):	
Testing Laboratory:	Shenzhen Tiansu Calibration and Testing Co.,Ltd
Testing location/ address.....:	B/1,4, NO.2 Jinlong Road, Longgang District, Shenzhen, China
Tested by (name, function, signature).....:	Dragon Xu \Test Engineer
Approved by (name, function, signature)...:	Duan jiang tao /Reviewer



List of Attachments (including a total number of pages in each attachment): <ul style="list-style-type: none">- Page 1 to 22 for IEC 62133 TRF (main report)- Attachment 1 (2 Page): Product Photos	
Summary of testing:	
Tests performed (name of test and test clause): Testing for cell: GX 450909 7.2.1 Continuous charging at constant voltage (cells) 7.3.1 External short-circuit (cell) 7.3.3 Free fall 7.3.4 Thermal abuse (cells) 7.3.5 Crush (cells) 7.3.7 Forced discharge (cells) 7.3.9 Forced internal short-circuit (cells) Tests are made with the number of in IEC 62133-2: 2017 Table 1.	Testing location: Shenzhen Tiansu Calibration and Testing Co.,Ltd B/1,4, NO.2 Jinlong Road, Longgang District, Shenzhen, China

Copy of marking plate:**The artwork below may be only a draft.**

Polymer Lithium-ion cell
Model: GX 450909
3.7V 30mAh 0.111Wh 1INP5/10/10

Made in China YYYYMMDD
Caution: Risk of Fire and Burns
Follow Manufacturer's Instructions



The sample is a small cell according to IEC 62133-2: 2017

cl. 8.2, the relevant requirements of the label will be described in the specification, including the product name, battery designation, manufacturer name and related warning “Keep small cells which are considered swallowable out of the reach of children. Swallowing may lead to burns, perforation of soft tissue, and death. Severe burns can occur within 2 h of ingestion. In case of ingestion of a cell or battery, seek medical assistance promptly.” , “caution for batteries which are considered swallowable” .

Remark:

The code “YYYYMMDD” represents that:

“YYYY” means year of production,

“MM” means month of production,

“DD” means day of production.

Test item particulars : --
Classification of installation and use : --
Supply Connection : DC Terminal
Recommend charging method declared by the manufacturer : CC/CV
Discharge current (0,2 It A) : 6mA
Specified final voltage : 3.0V
Upper limit charging voltage per cell : 4.20V
Maximum charging current : 30mA
Charging temperature upper limit : 45°C
Charging temperature lower limit : 0°C
Polymer cell electrolyte type : <input type="checkbox"/> gel polymer <input type="checkbox"/> solid polymer <input checked="" type="checkbox"/> N/A
Possible test case verdicts: - test case does not apply to the test object..... : N/A - test object does meet the requirement..... : P (Pass) - test object does not meet the requirement..... : F (Fail)
Testing : Date of receipt of test item : 2023-04-09 Date (s) of performance of tests : 2023-04-10 to 2023-04-26
General remarks: "(See Enclosure #)" refers to additional information appended to the report. "(See appended table)" refers to a table appended to the report. Throughout this report a <input type="checkbox"/> comma / <input checked="" type="checkbox"/> point is used as the decimal separator.
Name and address of factory (ies) : Same as applicant

General product information and other remarks:

The cell consists of the positive electrode plate, negative electrode plate, separator, electrolyte, case. The positive and negative electrode plates are housed in the case in the state being separated by the separator.

The main features of the cell are shown as below (clause 7.1.1):

Model	Nominal capacity	Nominal voltage	Nominal Charge Current	Nominal Discharge Current	Maximum Charge Current	Maximum Discharge Current	Maximum Charge Voltage	Cut-off Voltage
GX 450909	30mAh	3.7V	15mA	15mA	30mA	30mA	4.2V	3.0V

The main features of the cell are shown as below (clause 7.1.2):

Model	Upper limit charge voltage	Taper-off current	Lower charge temperature	Upper charge temperature
GX 450909	4.2V	1.5mA	0°C	45°C

IEC 62133-2			
Clause	Requirement + Test	Result - Remark	Verdict
4	PARAMETER MEASUREMENT TOLERANCES		P
	Parameter measurement tolerances		P
5	GENERAL SAFETY CONSIDERATIONS		P
5.1	General		P
	Cells and batteries so designed and constructed that they are safe under conditions of both intended use and reasonably foreseeable misuse		P
5.2	Insulation and wiring		N/A
	The insulation resistance between the positive terminal and externally exposed metal surfaces of the battery (excluding electrical contact surfaces) is not less than 5 M Ω	Cell only	N/A
	Insulation resistance (M Ω)..... :		—
	Internal wiring and insulation are sufficient to withstand maximum anticipated current, voltage and temperature requirements		N/A
	Orientation of wiring maintains adequate clearance and creepage distances between conductors		N/A
	Mechanical integrity of internal connections accommodates reasonably foreseeable misuse		N/A
5.3	Venting		P
	Battery cases and cells incorporate a pressure relief mechanism or are constructed so that they relieve excessive internal pressure at a value and rate that will preclude rupture, explosion and self-ignition	Venting mechanism exists on the narrow side of pouch cell.	P
	Encapsulation used to support cells within an outer casing does not cause the battery to overheat during normal operation nor inhibit pressure relief		N/A
5.4	Temperature, voltage and current management		N/A
	Batteries are designed such that abnormal temperature rise conditions are prevented	Cell only	N/A
	Batteries are designed to be within temperature, voltage and current limits specified by the cell manufacturer		N/A
	Batteries are provided with specifications and charging instructions for equipment manufacturers so that specified chargers are designed to maintain charging within the temperature, voltage and current limits specified		N/A
5.5	Terminal contacts		P

IEC 62133-2			
Clause	Requirement + Test	Result - Remark	Verdict
	The size and shape of the terminal contacts ensure that they can carry the maximum anticipated current		P
	External terminal contact surfaces are formed from conductive materials with good mechanical strength and corrosion resistance		P
	Terminal contacts are arranged to minimize the risk of short-circuit		P
5.6	Assembly of cells into batteries		N/A
5.6.1	General		N/A
	Each battery have an independent control and protection for current, voltage, temperature and any other parameter required for safety and to maintain the cells within their operating region	Cell only	N/A
	This protection may be provided external to the battery such as within the charger or the end devices		N/A
	If protection is external to the battery, the manufacturer of the battery provide this safety relevant information to the external device manufacturer for implementation		N/A
	If there is more than one battery housed in a single battery case, each battery have protective circuitry that can maintain the cells within their operating regions		N/A
	Manufacturers of cells specify current, voltage and temperature limits so that the battery manufacturer/designer may ensure proper design and assembly		N/A
	Batteries that are designed for the selective discharge of a portion of their series connected cells incorporate circuitry to prevent operation of cells outside the limits specified by the cell manufacturer		N/A
	Protective circuit components added as appropriate and consideration given to the end-device application		N/A
	The manufacturer of the battery provide a safety analysis of the battery safety circuitry with a test report including a fault analysis of the protection circuit under both charging and discharging conditions confirming the compliance		N/A
5.6.2	Design recommendation		N/A
	For the battery consisting of a single cell or a single cellblock, it is recommended that the charging voltage of the cell does not exceed the upper limit of the charging voltage specified in Table 2	Cell only	N/A

IEC 62133-2			
Clause	Requirement + Test	Result - Remark	Verdict
	For the battery consisting of series-connected plural single cells or series-connected plural cellblocks, it is recommended that the voltages of any one of the single cells or single cellblocks does not exceed the upper limit of the charging voltage, specified in Table 2, by monitoring the voltage of every single cell or the single cellblocks		N/A
	For the battery consisting of series-connected plural single cells or series-connected plural cellblocks, it is recommended that charging is stopped when the upper limit of the charging voltage is exceeded for any one of the single cells or single cellblocks by measuring the voltage of every single cell or the single cellblocks		N/A
	For batteries consisting of series-connected cells or cell blocks, nominal charge voltage not be counted as an overcharge protection		N/A
	For batteries consisting of series-connected cells or cell blocks, cells have closely matched capacities, be of the same design, be of the same chemistry and be from the same manufacturer		N/A
	It is recommended that the cells and cell blocks not discharged beyond the cell manufacturer's specified final voltage		N/A
	For batteries consisting of series-connected cells or cell blocks, cell balancing circuitry incorporated into the battery management system		N/A
5.6.3	Mechanical protection for cells and components of batteries	Cell only	N/A
	Mechanical protection for cells, cell connections and control circuits within the battery provided to prevent damage as a result of intended use and reasonably foreseeable misuse		N/A
	The mechanical protection can be provided by the battery case or it can be provided by the end product enclosure for those batteries intended for building into an end product		N/A
	The battery case and compartments housing cells designed to accommodate cell dimensional tolerances during charging and discharging as recommended by the cell manufacturer		N/A
	For batteries intended for building into a portable end product, testing with the battery installed within the end product considered when conducting mechanical tests		N/A
5.7	Quality plan		N/A

IEC 62133-2			
Clause	Requirement + Test	Result - Remark	Verdict
	The manufacturer prepares and implements a quality plan that defines procedures for the inspection of materials, components, cells and batteries and which covers the whole process of producing each type of cell or battery	No relevant documents provided	N/A
5.8	Battery safety components		N/A
	According annex F		N/A
6	TYPE TEST AND SAMPLE SIZE		P
	Tests are made with the number of cells or batteries specified in Table 1 using cells or batteries that are not more than six months old	Tests are performed according to specified in Table 1 of this standard. The samples are not more than six months old.	P
	Coin cells with resistance $\leq 3 \Omega$ (measured according annex D) are tested according table 1	Not coin cells.	N/A
	Unless otherwise specified, tests are carried out in an ambient temperature of $20 \text{ }^\circ\text{C} \pm 5 \text{ }^\circ\text{C}$		P
	The safety analysis of 5.6.1 identify those components of the protection circuit that are critical for short-circuit, overcharge and overdischarge protection	Cell only.	N/A
	When conducting the short-circuit test, consideration given to the simulation of any single fault condition that is likely to occur in the protecting circuit that would affect the short-circuit test		N/A
7	SPECIFIC REQUIREMENTS AND TESTS		P
7.1	Charging procedure for test purposes		P
7.1.1	First procedure		P
	This charging procedure applies to subclauses other than those specified in 7.1.2		P
	Unless otherwise stated in this document, the charging procedure for test purposes is carried out in an ambient temperature of $20 \text{ }^\circ\text{C} \pm 5 \text{ }^\circ\text{C}$, using the method declared by the manufacturer		P
	Prior to charging, the battery have been discharged at $20 \text{ }^\circ\text{C} \pm 5 \text{ }^\circ\text{C}$ at a constant current of 0,2 It A down to a specified final voltage		P
7.1.2	Second procedure		P
	This charging procedure applies only to 7.3.1, 7.3.4, 7.3.5, and 7.3.9		P

IEC 62133-2			
Clause	Requirement + Test	Result - Remark	Verdict
	After stabilization for 1 h and 4 h, respectively, at ambient temperature of highest test temperature and lowest test temperature, as specified in Table 2, cells are charged by using the upper limit charging voltage and maximum charging current, until the charging current is reduced to 0,05 It A, using a constant voltage charging method	Highest test temperature: 45°C Lowest test temperature: 0°C	P
7.2	Intended use		P
7.2.1	Continuous charging at constant voltage (cells)	Tested complied.	P
	Fully charged cells are subjected for 7 days to a charge using the charging method for current and standard voltage specified by the cell manufacturer		P
	Results: No fire. No explosion. No leakage..... :	(See appended table 7.2.1)	P
7.2.2	Case stress at high ambient temperature (battery)		N/A
	Oven temperature (°C)..... :		—
	Results: No physical distortion of the battery case resulting in exposure of internal protective components and cells		N/A
7.3	Reasonably foreseeable misuse		P
7.3.1	External short-circuit (cell)	Tested complied.	P
	The cells were tested until one of the following occurred:		P
	- 24 hours elapsed; or		N/A
	- The case temperature declined by 20 % of the maximum temperature rise		P
	Results: No fire. No explosion..... :	(See appended table 7.3.1)	P
7.3.2	External short-circuit (battery)	Cell only	N/A
	The batteries were tested until one of the following occurred:		N/A
	- 24 hours elapsed; or		N/A
	- The case temperature declined by 20 % of the maximum temperature rise		N/A
	In case of rapid decline in short circuit current, the battery pack remained on test for an additional one hour after the current reached a low end steady state condition		N/A
	A single fault in the discharge protection circuit conducted on one to four (depending upon the protection circuit) of the five samples before conducting the short-circuit test		N/A

IEC 62133-2			
Clause	Requirement + Test	Result - Remark	Verdict
	A single fault applies to protective component parts such as MOSFET, fuse, thermostat or positive temperature coefficient (PTC) thermistor		N/A
	Results: No fire. No explosion..... :		N/A
7.3.3	Free fall	Cell only	P
	Results: No fire. No explosion		P
7.3.4	Thermal abuse (cells)	Tested complied.	P
	Oven temperature (°C)..... :	130	—
	Results: No fire. No explosion		P
7.3.5	Crush (cells)	Tested complied.	P
	The crushing force was released upon:		P
	- The maximum force of 13 kN \times 0,78 kN has been applied; or		P
	- An abrupt voltage drop of one-third of the original voltage has been obtained		N/A
	Results: No fire. No explosion..... :	(See appended table 7.3.5)	P
7.3.6	Over-charging of battery	Cell only	N/A
	The supply voltage which is:		N/A
	- 1,4 times the upper limit charging voltage presented in Table A.1 (but not to exceed 6,0 V) for single cell/cell block batteries or		N/A
	- 1,2 times the upper limit charging voltage resented in Table A.1 per cell for series connected multi-cell batteries, and		N/A
	- Sufficient to maintain a current of 2,0 It A throughout the duration of the test or until the supply voltage is reached		N/A
	Test was continued until the temperature of the outer casing:		N/A
	- Reached steady state conditions (less than 10 °C change in 30-minute period); or		N/A
	- Returned to ambient		N/A
	Results: No fire. No explosion..... :		N/A
7.3.7	Forced discharge (cells)	Tested complied.	P
	If the discharge voltage reaches the negative value of upper limit charging voltage within the testing duration, the voltage is maintained at the negative value of the upper limit charging voltage by reducing the current for the remainder of the testing duration		N/A

IEC 62133-2			
Clause	Requirement + Test	Result - Remark	Verdict
	If the discharge voltage does not reach the negative value of upper limit charging voltage within the testing duration, the test is terminated at the end of the testing duration		P
	Results: No fire. No explosion..... :	(See appended table 7.3.7)	P
7.3.8	Mechanical tests (batteries)	Cell only	N/A
7.3.8.1	Vibration		N/A
	Results: No fire, no explosion, no rupture, no leakage or venting..... :		N/A
7.3.8.2	Mechanical shock		N/A
	Results: No leakage, no venting, no rupture, no explosion and no fire..... :		N/A
7.3.9	Design evaluation – Forced internal short-circuit (cells)	Tested complied.	P
	The cells complied with national requirement for..... :	France, Japan, Republic of Korea, Switzerland	—
	The pressing was stopped upon:		P
	- A voltage drop of 50 mV has been detected; or		N/A
	- The pressing force of 800 N (cylindrical cells) or 400 N (prismatic cells) has been reached	400N for prismatic cells.	P
	Results: No fire..... :	(See appended table 7.3.9)	P
8	INFORMATION FOR SAFETY		P
8.1	General		P
	Manufacturers of secondary cells ensure that information is provided about current, voltage and temperature limits of their products	Information for safety mentioned in manufacturer's specifications	P
	Manufacturers of batteries ensure that equipment manufacturers and, in the case of direct sales, end-users are provided with information to minimize and mitigate hazards	Information for safety mentioned in manufacturer's specifications	P
	Systems analyses performed by device manufacturers to ensure that a particular battery design prevents hazards from occurring during use of a product		N/A
	As appropriate, any information relating to hazard avoidance resulting from a system analysis provided to the end user		N/A
	Do not allow children to replace batteries without adult supervision		N/A
8.2	Small cell and battery safety information	Small cells.	P

IEC 62133-2			
Clause	Requirement + Test	Result - Remark	Verdict
	The following warning language is to be provided with the information packaged with the small cells and batteries or equipment using them:		N/A
	- Keep small cells and batteries which are considered swallowable out of the reach of children		P
	- Swallowing may lead to burns, perforation of soft tissue, and death. Severe burns can occur within 2 h of ingestion		P
	- In case of ingestion of a cell or battery, seek medical assistance promptly		P
9	MARKING		P
9.1	Cell marking		P
	Cells marked as specified in IEC 61960, except coin cells	IEC Designation: 1INP5/10/12, see marking plate on page 3.	P
	Coin cells whose external surface area is too small to accommodate the markings on the cells show the designation and polarity	Not coin cells.	N/A
	By agreement between the cell manufacturer and the battery and/or end product manufacturer, component cells used in the manufacture of a battery need not be marked		N/A
9.2	Battery marking	Cell only	N/A
	Batteries marked as specified in IEC 61960, except for coin batteries		N/A
	Coin batteries whose external surface area is too small to accommodate the markings on the batteries show the designation and polarity. Batteries also marked with an appropriate caution statement		N/A
	Terminals have clear polarity marking on the external surface of the battery		N/A
	Batteries with keyed external connectors designed for connection to specific end products need not be marked with polarity markings if the design of the external connector prevents reverse polarity connections		N/A
9.3	Caution for ingestion of small cells and batteries		P
	Coin cells and batteries identified as small batteries according to 8.2 include a caution statement regarding the hazards of ingestion in accordance with 8.2		N/A

IEC 62133-2			
Clause	Requirement + Test	Result - Remark	Verdict
	When small cells and batteries are intended for direct sale in consumer-replaceable applications, caution for ingestion given on the immediate package	See page 3.	P
9.4	Other information		P
	Storage and disposal instructions		P
	Recommended charging instructions		P
10	PACKAGING AND TRANSPORT		P
	Packaging for coin cells not small enough to fit within the limits of the ingestion gauge of Figure 3	Not coin cells	N/A
	The materials and packaging design are chosen so as to prevent the development of unintentional electrical conduction, corrosion of the terminals and ingress of environmental contaminants		P
ANNEX A	CHARGING AND DISCHARGING RANGE OF SECONDARY LITHIUM ION CELLS FOR SAFE USE		P
A.1	General		P
A.2	Safety of lithium ion secondary battery		P
A.3	Consideration on charging voltage		P
A.3.1	General		P
A.3.2	Upper limit charging voltage	Upper limit charging voltage of cell is 4.20V.	P
A.3.2.1	General		P
A.3.2.2	Explanation of safety viewpoint		N/A
A.3.2.3	Safety requirements, when different upper limit charging voltage is applied		N/A
A.4	Consideration of temperature and charging current		P
A.4.1	General		P
A.4.2	Recommended temperature range	Charging temperature range declared by client is 0-45°C	N/A
A.4.2.1	General		N/A
A.4.2.2	Safety consideration when a different recommended temperature range is applied		N/A
A.4.3	High temperature range		N/A
A.4.3.1	General		N/A
A.4.3.2	Explanation of safety viewpoint		N/A

IEC 62133-2			
Clause	Requirement + Test	Result - Remark	Verdict
A.4.3.3	Safety considerations when specifying charging conditions in the high temperature range		N/A
A.4.3.4	Safety considerations when specifying a new upper limit in the high temperature range		N/A
A.4.4	Low temperature range		N/A
A.4.4.1	General		N/A
A.4.4.2	Explanation of safety viewpoint		N/A
A.4.4.3	Safety considerations, when specifying charging conditions in the low temperature range		N/A
A.4.4.4	Safety considerations when specifying a new lower limit in the low temperature range		N/A
A.4.5	Scope of the application of charging current		P
A.4.6	Consideration of discharge		P
A.4.6.1	General		P
A.4.6.2	Final discharge voltage and explanation of safety viewpoint	Cell specified final voltage is 3.0V	P
A.4.6.3	Discharge current and temperature range		P
A.4.6.4	Scope of application of the discharging current		P
A.5	Sample preparation		P
A.5.1	General		P
A.5.2	Insertion procedure for nickel particle to generate internal short		P
A.5.3	Disassembly of charged cell		P
A.5.4	Shape of nickel particle		P
A.5.5	Insertion of nickel particle in cylindrical cell		N/A
A.5.5.1	Insertion of nickel particle in winding core		N/A
A.5.5.2	Marking the position of the nickel particle on both ends of the winding core of the separator		N/A
A.5.6	Insertion of nickel particle in prismatic cell		P
A.6	Experimental procedure of the forced internal short-circuit test		P
A.6.1	Material and tools for preparation of nickel particle		P
A.6.2	Example of a nickel particle preparation procedure		P
A.6.3	Positioning (or placement) of a nickel particle		P
A.6.4	Damaged separator precaution		P
A.6.5	Caution for rewinding separator and electrode		P
A.6.6	Insulation film for preventing short-circuit		P

IEC 62133-2			
Clause	Requirement + Test	Result - Remark	Verdict
A.6.7	Caution when disassembling a cell		P
A.6.8	Protective equipment for safety		P
A.6.9	Caution in the case of fire during disassembling		P
A.6.10	Caution for the disassembling process and pressing the electrode core		P
A.6.11	Recommended specifications for the pressing device		P
ANNEX B	RECOMMENDATIONS TO EQUIPMENT MANUFACTURERS AND BATTERY ASSEMBLERS		P
ANNEX C	RECOMMENDATIONS TO THE END-USERS		P
ANNEX D	MEASUREMENT OF THE INTERNAL AC RESISTANCE FOR COIN CELLS		N/A
D.1	General		N/A
D.2	Method		N/A
	A sample size of three coin cells is required for this measurement.....:	(See appended table D.2)	N/A
	Coin cells with an internal resistance of less than or equal to 3 Ω are subjected to the testing according to Clause 6 and Table 1		N/A
	Coin cells with an internal resistance greater than 3 Ω require no further testing		N/A
ANNEX E	PACKAGING AND TRANSPORT		N/A
ANNEX F	COMPONENT STANDARDS REFERENCES		P

IEC 62133-2			
Clause	Requirement + Test	Result - Remark	Verdict

TABLE: Critical components information					
Object / part No.	Manufacturer / trademark	Type / model	Technical data	Standard	Mark(s) of conformity ¹⁾

Supplementary information:

1) Provided evidence ensures the agreed level of compliance. See OD-CB2039.

IEC 62133-2			
Clause	Requirement + Test	Result - Remark	Verdict

7.2.1	TABLE: Continuous charging at constant voltage (cells)				P
Sample no.	Recommended charging voltage Vc (Vdc)	Recommended charging current I _{rec} (A)	OCV before test (Vdc)	Results	
C01#	4.2	0.015	4.189	P	
C02#	4.2	0.015	4.190	P	
C03#	4.2	0.015	4.189	P	
C04#	4.2	0.015	4.190	P	
C05#	4.2	0.015	4.190	P	

Supplementary information:

- No fire or explosion
- No leakage
- The ambient temperature is 23.3°C

7.3.1	TABLE: External short-circuit (cell)					P
Sample no.	Ambient T (°C)	OCV before test (Vdc)	Resistance of circuit (mΩ)	Maximum case temperature rise ΔT (K)	Results	
Samples charged at charging temperature upper limit¹⁾						
C06#	54.9	4.169	81	63.6	P	
C07#	54.9	4.167	79	63.4	P	
C08#	54.9	4.169	76	60.9	P	
C09#	54.9	4.170	84	59.5	P	
C10#	54.9	4.165	86	63.7	P	
Samples charged at charging temperature lower limit²⁾						
C11#	54.2	4.112	76	58.0	P	
C12#	54.2	4.109	74	57.0	P	
C13#	54.2	4.121	85	59.0	P	
C14#	54.2	4.111	87	54.3	P	
C15#	54.2	4.128	84	53.7	P	

Supplementary information:

- No fire or explosion
- ¹⁾ Cells charged at 45°C
- ²⁾ Cells charged at 0°C

IEC 62133-2						
Clause	Requirement + Test				Result - Remark	Verdict
7.3.2	TABLE: External short-circuit (battery)					N/A
Sample no.	Ambient T (°C)	OCV before test (Vdc)	Resistance of circuit (mΩ)	Maximum case temperature rise ΔT (K)	Component single fault condition	Results
--	--	--	--	--	--	--
--	--	--	--	--	--	--
--	--	--	--	--	--	--
--	--	--	--	--	--	--
--	--	--	--	--	--	--
Supplementary information:						
- No fire or explosion						
- SC means short-circuit						

7.3.5	TABLE: Crush (cells)				P
Sample no.	OCV before test (Vdc)	OCV at removal of crushing force (Vdc)	Maximum force applied to the cell during crush (kN)	Results	
Samples charged at charging temperature upper limit¹⁾					
C29#	4.170	4.170	12.90	P	
C30#	4.182	4.179	12.98	P	
C31#	4.172	4.171	12.96	P	
C32#	4.170	4.169	12.90	P	
C33#	4.181	4.180	13.03	P	
Samples charged at charging temperature lower limit²⁾					
C34#	4.107	4.104	12.94	P	
C35#	4.101	4.101	13.02	P	
C36#	4.120	4.120	12.98	P	
C37#	4.124	4.122	12.95	P	
C38#	4.115	4.113	12.93	P	
Supplementary information:					
- No fire or explosion					
1) Cells charged at 45°C					
2) Cells charged at 0°C					
- The ambient temperature is 23.1°C					

IEC 62133-2						
Clause	Requirement + Test			Result - Remark	Verdict	
7.3.6	TABLE: Over-charging of battery				N/A	
Constant charging current (A).....:					--	-
Supply voltage (Vdc).....:					--	-
Sample no.	OCV before charging (Vdc)	Total charging time (minute)	Maximum outer case temperature (°C)	Results		
--	--	--	--	--		
--	--	--	--	--		
--	--	--	--	--		
--	--	--	--	--		
--	--	--	--	--		
Supplementary information:						
- No fire or explosion						
- The ambient temperature is °C						

7.3.7	TABLE: Forced discharge (cells)				P
Sample no.	OCV before application of reverse charge (Vdc)	Measured reverse charge I_t (A)	Lower limit discharge voltage (Vdc)	Results	
C39#	3.310	0.03	3.0	P	
C40#	3.275	0.03	3.0	P	
C41#	3.316	0.03	3.0	P	
C42#	3.257	0.03	3.0	P	
C43#	3.254	0.03	3.0	P	
Supplementary information:					
- No fire or explosion					
- The ambient temperature is 23.1°C					

7.3.8.1	TABLE: Vibration					N/A
Sample no.	OCV before test (Vdc)	OCV after test (Vdc)	Mass before test (g)	Mass after test (g)	Results	
--	--	--	--	--	--	
--	--	--	--	--	--	
--	--	--	--	--	--	
Supplementary information:						
- No fire or explosion						
- No rupture						
- No leakage						
- No venting						
- The ambient temperature is °C						

IEC 62133-2						
Clause	Requirement + Test				Result - Remark	Verdict
7.3.8.2	TABLE: Mechanical shock					N/A
Sample no.	OCV before test (Vdc)	OCV after test (Vdc)	Mass before test (g)	Mass after test (g)	Results	
--	--	--	--	--	--	
--	--	--	--	--	--	
--	--	--	--	--	--	
Supplementary information:						
- No fire or explosion - No rupture - No leakage - No venting - The ambient temperature is °C						

7.3.9※	TABLE: Forced internal short circuit (cells)					P
Sample no.	Chamber ambient T (°C)	OCV before test (Vdc)	Particle location ¹⁾	Maximum applied pressure (N)	Results	
Samples charged at charging temperature upper limit²⁾						
C44#	45	4.172	1*	400	P	
C45#	45	4.171	1*	400	P	
C46#	45	4.178	1	400	P	
C47#	45	4.166	1	400	P	
C48#	45	4.178	1	400	P	
Samples charged at charging temperature lower limit³⁾						
C49#	0	4.098	1*	400	P	
C50#	0	4.108	1*	400	P	
C51#	0	4.115	1	400	P	
C52#	0	4.114	1	400	P	
C53#	0	4.127	1	400	P	
Supplementary information:						
¹⁾ Identify one of the following: 1: Nickel particle inserted between positive and negative (active material) coated area. 2: Nickel particle inserted between positive aluminium foil and negative active material coated area. ²⁾ Cells charged at 45°C ³⁾ Cells charged at 0°C						

IEC 62133-2				
Clause	Requirement + Test	Result - Remark	Verdict	
D.2	TABLE: Internal AC resistance for coin cells			N/A
Sample no.	Ambient T (°C)	Store time (h)	Resistance Rac (Ω)	Results ¹⁾
Supplementary information:				
¹⁾ Coin cells with internal resistance less than or equal to 3Ω , see test result on corresponding tables				



View of cell-1

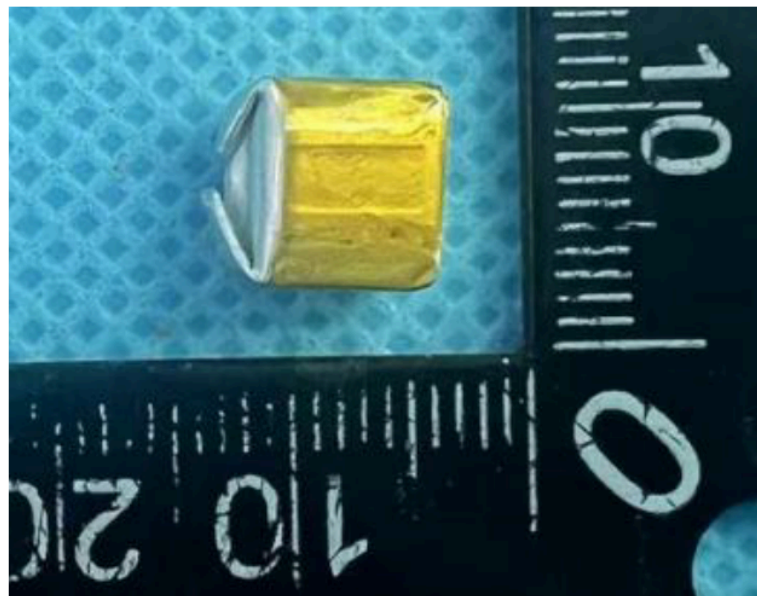

View of cell-2



View of cell-3



View of cell-4

TEST REPORT

IEC 62133-2: 2017

**Secondary cells and batteries containing alkaline or other non-acid electrolytes
Safety requirements for portable sealed secondary cells, and for batteries made
from them, for use in portable applications
Part 2: Lithium systems**

Report Number: TCT230223B135

Date of issue: 2023-02-23

Total number of pages: 25 Pages.

Tested by (name + signature): Zoey Zhou

Inspected by (name + signature): Jokin Teng

Approved by (name + signature): Tomsin



Testing laboratory: Shenzhen TCT Testing Technology Co., Ltd.

Address: 1B/F., Building 1, Yibaolai Industrial Park, Qiaotou,
Fuyong, Baoan District, Shenzhen, Guangdong,
China.

Testing location: As above

Applicant's name

Address

Manufacturer's name

Address

Test specification:

Standard: IEC 62133-2: 2017

Test procedure: Type approved

Test result: Pass

Non-standard test method: N/A

The test results presented in this report relate only to the object tested. This report shall not be reproduced, except in full, without the written approval of the Issuing Shenzhen TCT Testing Technology Co., Ltd.

Test item description: Li-ion Polymer Battery

Trade Mark: N/A

Model/type reference: 402030

Ratings: 3.7V, 185mAh, 0.68Wh

List of Attachments (including a total number of pages in each attachment):

Attachment 1: Critical components information (page 17)

Attachment 2: Photo documentation (page 22-25)

Summary of testing:

Tests performed (name of test and test clause):

- cl.5.6.2 Design recommendation;
- cl.7.1 Charging procedure for test purposes (for Cells and Batteries);
- cl.7.2.1 Continuous charging at constant voltage (Cells);
- cl.7.3.1 External short circuit (Cells);
- cl.7.3.2 External short circuit (Batteries);
- cl.7.3.3 Free fall (Cells and Batteries);
- cl.7.3.4 Thermal abuse (Cells);
- cl.7.3.5 Crush (Cells);
- cl.7.3.6 Over-charging of battery;
- cl.7.3.7 Forced discharge (Cells);
- cl.7.3.8 Mechanical tests (Batteries)

The electrolyte type of this cell doesn't belong to polymer, and the applicant declares that this cell isn't to be sold in France, Japan, Republic of Korea and Switzerland.

Tests are made with the number of cells and batteries specified in IEC 62133-2: 2017 Table 1.

Testing location:

Shenzhen TCT Testing Technology Co., Ltd.
1B/F., Building 1, Yibaolai Industrial Park, Qiaotou, Fuyong, Baoan District, Shenzhen, Guangdong, China.

The product fulfils the requirements of EN 62133-2: 2017

Copy of marking plate:

The artwork below may be only a draft

- (Black) Li-ion Polymer Battery

Model: 402030 1ICP6/12/31

3.7V, 185mAh, 0.68Wh

+ (Red) Date: YYYYMMDD

Made in China

WARNING: Risk of Fire and Burns. Do Not Open, Crush, Heat Above 45°C/113°F or Incinerate.

Do not short circuit. If bulges severely, discontinue use. Follow Manufacturer's Instructions.

Date code: YYYYMMDD

YYYY=Year, MM=Month, DD=Day.

Test item particulars..... :	
Classification of installation and use..... :	To be defined in final product
Supply Connection..... :	DC Lead wire
Recommend charging method declared by the manufacturer	Charging the battery with 37mA constant current and 4.2V constant voltage until the current reduces to 1.85mA at ambient 20°C±5°C.
Discharge current (0,2 It A)	37mA
Specified final voltage..... :	2.75V
Upper limit charging voltage per cell..... :	4.2V
Maximum charging current	185mA
Charging temperature upper limit	45°C
Charging temperature lower limit..... :	0°C
Polymer cell electrolyte type..... :	<input type="checkbox"/> gel polymer <input type="checkbox"/> solid polymer <input checked="" type="checkbox"/> N/A
Possible test case verdicts:	
- test case does not apply to the test object..... : N/A	
- test object does meet the requirement..... : P (Pass)	
- test object does not meet the requirement..... : F (Fail)	
Testing..... :	
Date of receipt of test item	2023-02-10
Date (s) of performance of tests	2023-02-10 to 2023-02-22
General remarks:	
The test results presented in this report relate only to the object tested, This report shall not be reproduced, except in full, without the written approval of the issuing testing laboratory, “(Cell #XX)” refers to sample number of cells, “X” is 0~9; “(Battery #XX)” refers to sample number of batteries, “X” is 0~9; “(see below table)” refers to a table appended to the report.	
Throughout this report a point is used as the decimal separator.	
When differences exist; they shall be identified in the General product information section.	
Name and address of factory (ies)	Same as applicant.

General product information and other remarks:

This battery is constructed with one lithium-ion cell, and has overcharge, over-discharge, over current and short-circuits proof circuit.

The main features of the battery are shown as below (clause 7.1.1):

Model (Battery)	Nominal capacity	Nominal voltage	Nominal Charge Current	Nominal Discharge Current	Maximum Charge Current	Maximum Discharge Current	Maximum Charge Voltage	Final Voltage
402030	185mAh	3.7V	37mA	37mA	185mA	185mA	4.2V	2.75V

The main features of the cell in the battery are shown as below (clause 7.1.1):

Model (Cell)	Nominal capacity	Nominal voltage	Nominal Charge Current	Nominal Discharge Current	Maximum Charge Current	Maximum Discharge Current	Maximum Charge Voltage	Final Voltage
402030	185mAh	3.7V	37mA	37mA	185mA	185mA	4.2V	2.75V

The main features of the cell in the battery are shown as below (clause 7.1.2):

Model (Cell)	Upper limit charge voltage	Taper-off current (0.05 It A)	Lower charge temperature	Upper charge temperature
402030	4.2V	9.25mA	0°C	45°C

Construction:

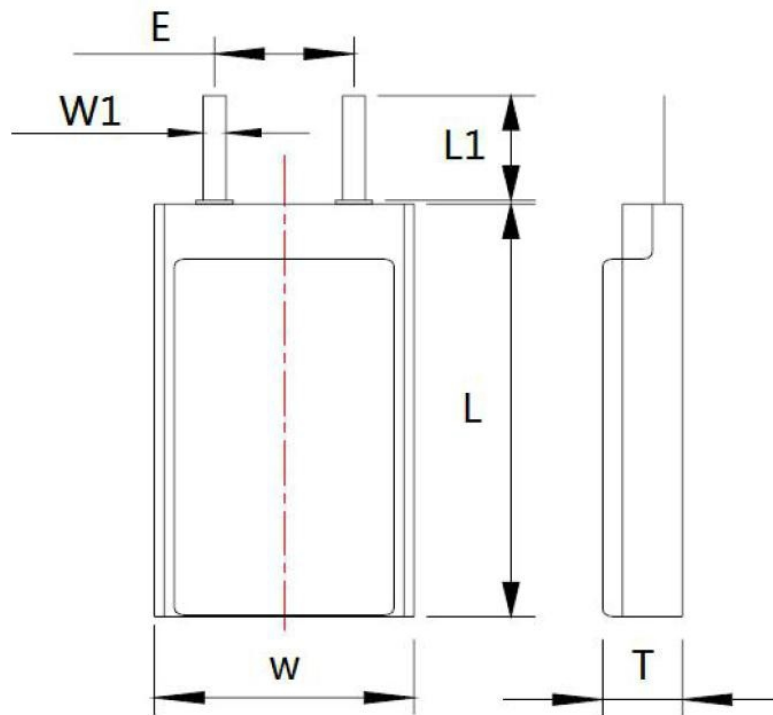

T: 6.0mm max W: 12.0mm max L: 30.5mm max
Cell

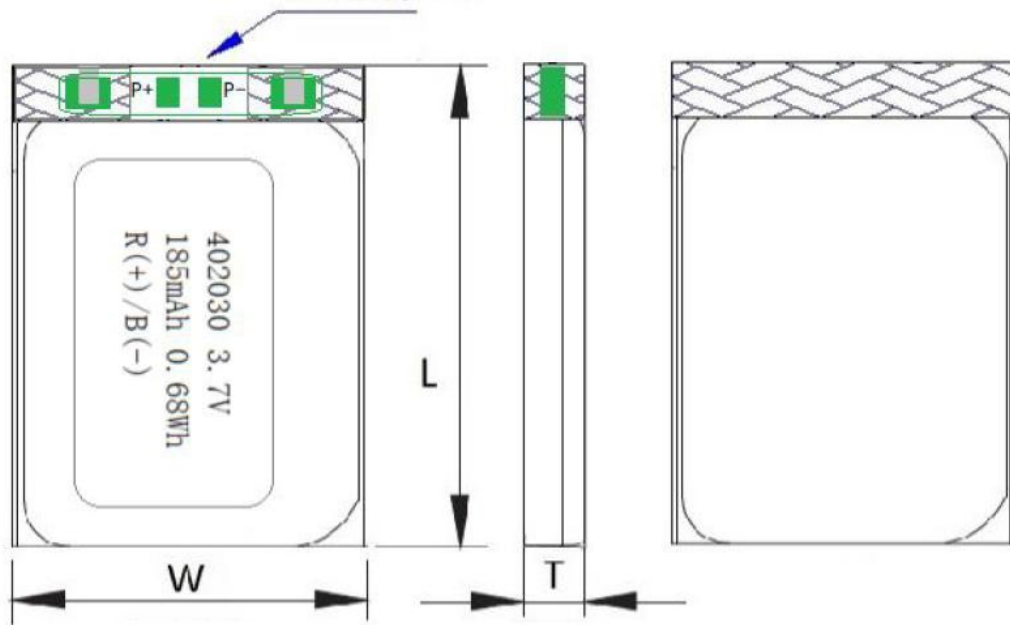

T: 6.0mm max W: 12.0mm max H: 32.5mm max
Battery

Circuit diagram:

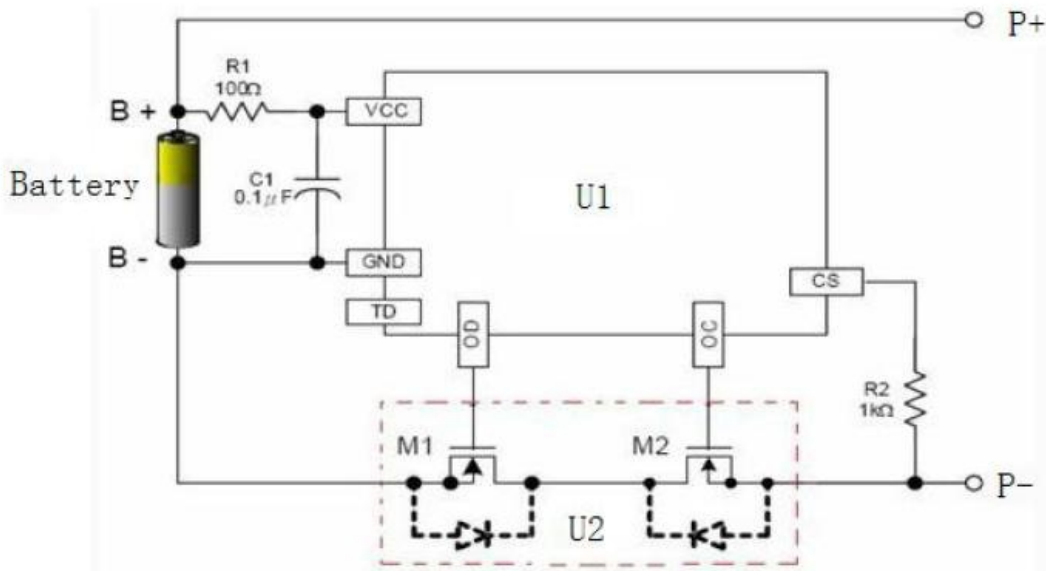

IEC 62133-2: 2017			
Clause	Requirement + Test	Result - Remark	Verdict
4	PARAMETER MEASUREMENT TOLERANCES		P
	Parameter measurement tolerances		P
5	GENERAL SAFETY CONSIDERATIONS		P
5.1	General		P
	Cells and batteries so designed and constructed that they are safe under conditions of both intended use and reasonably foreseeable misuse		P
5.2	Insulation and wiring		P
	The insulation resistance between the positive terminal and externally exposed metal surfaces of the battery (excluding electrical contact surfaces) is not less than 5 MΩ	No metal surface exists.	N/A
	Insulation resistance (MΩ)..... :		—
	Internal wiring and insulation are sufficient to withstand maximum anticipated current, voltage and temperature requirements		P
	Orientation of wiring maintains adequate clearance and creepage distances between conductors		P
	Mechanical integrity of internal connections accommodates reasonably foreseeable misuse		P
5.3	Venting		P
	Battery cases and cells incorporate a pressure relief mechanism or are constructed so that they relieve excessive internal pressure at a value and rate that will preclude rupture, explosion and self-ignition	Venting mechanism exists on the narrow side of pouch cell.	P
	Encapsulation used to support cells within an outer casing does not cause the battery to overheat during normal operation nor inhibit pressure relief		N/A
5.4	Temperature, voltage and current management		P
	Batteries are designed such that abnormal temperature rise conditions are prevented	Overcharge, over discharge, over current and short-circuit proof circuit used in this battery. See tests of clause 7.	P
	Batteries are designed to be within temperature, voltage and current limits specified by the cell manufacturer	See above.	P
	Batteries are provided with specifications and charging instructions for equipment manufacturers so that specified chargers are designed to maintain charging within the temperature, voltage and current limits specified	The charging limits specified in the manufacturer's specification.	P
5.5	Terminal contacts		P

IEC 62133-2: 2017			
Clause	Requirement + Test	Result - Remark	Verdict
	The size and shape of the terminal contacts ensure that they can carry the maximum anticipated current	DC Lead wire contacts complied with the requirements.	P
	External terminal contact surfaces are formed from conductive materials with good mechanical strength and corrosion resistance		P
	Terminal contacts are arranged to minimize the risk of short-circuit		P
5.6	Assembly of cells into batteries		P
5.6.1	General		P
	Each battery have an independent control and protection for current, voltage, temperature and any other parameter required for safety and to maintain the cells within their operating region	Protective circuit equipped on battery.	P
	This protection may be provided external to the battery such as within the charger or the end devices		N/A
	If protection is external to the battery, the manufacturer of the battery provide this safety relevant information to the external device manufacturer for implementation		N/A
	If there is more than one battery housed in a single battery case, each battery have protective circuitry that can maintain the cells within their operating regions		N/A
	Manufacturers of cells specify current, voltage and temperature limits so that the battery manufacturer/designer may ensure proper design and assembly	Current, voltage and temperature limits specified by cell manufacturer.	P
	Batteries that are designed for the selective discharge of a portion of their series connected cells incorporate circuitry to prevent operation of cells outside the limits specified by the cell manufacturer		N/A
	Protective circuit components added as appropriate and consideration given to the end-device application		P
	The manufacturer of the battery provide a safety analysis of the battery safety circuitry with a test report including a fault analysis of the protection circuit under both charging and discharging conditions confirming the compliance	Safety analysis report provided by manufacturer.	P
5.6.2	Design recommendation		P
	For the battery consisting of a single cell or a single cellblock, it is recommended that the charging voltage of the cell does not exceed the upper limit of the charging voltage specified in Table 2	Single cell battery, Max. Charging voltage of cell: 4.2V.	P

IEC 62133-2: 2017			
Clause	Requirement + Test	Result - Remark	Verdict
	For the battery consisting of series-connected plural single cells or series-connected plural cellblocks, it is recommended that the voltages of any one of the single cells or single cellblocks does not exceed the upper limit of the charging voltage, specified in Table 2, by monitoring the voltage of every single cell or the single cellblocks		N/A
	For the battery consisting of series-connected plural single cells or series-connected plural cellblocks, it is recommended that charging is stopped when the upper limit of the charging voltage is exceeded for any one of the single cells or single cellblocks by measuring the voltage of every single cell or the single cellblocks		N/A
	For batteries consisting of series-connected cells or cell blocks, nominal charge voltage not be counted as an overcharge protection		N/A
	For batteries consisting of series-connected cells or cell blocks, cells have closely matched capacities, be of the same design, be of the same chemistry and be from the same manufacturer		N/A
	It is recommended that the cells and cell blocks not discharged beyond the cell manufacturer's specified final voltage	Final voltage of cell: 2.75V, not exceed the final voltage specified by cell manufacturer.	P
	For batteries consisting of series-connected cells or cell blocks, cell balancing circuitry incorporated into the battery management system		N/A
5.6.3	Mechanical protection for cells and components of batteries		P
	Mechanical protection for cells, cell connections and control circuits within the battery provided to prevent damage as a result of intended use and reasonably foreseeable misuse	Mechanical protection for cell connections and control circuits provided.	P
	The mechanical protection can be provided by the battery case or it can be provided by the end product enclosure for those batteries intended for building into an end product	Build-in batteries, mechanical protection for cells should be provided by end product.	N/A
	The battery case and compartments housing cells designed to accommodate cell dimensional tolerances during charging and discharging as recommended by the cell manufacturer	To be evaluated in final system.	N/A
	For batteries intended for building into a portable end product, testing with the battery installed within the end product considered when conducting mechanical tests		N/A
5.7	Quality plan		P

IEC 62133-2: 2017			
Clause	Requirement + Test	Result - Remark	Verdict
	The manufacturer prepares and implements a quality plan that defines procedures for the inspection of materials, components, cells and batteries and which covers the whole process of producing each type of cell or battery	Complied. ISO 9001: 2015 Certificate provided.	P
5.8	Battery safety components		N/A
	According annex F	See TABLE: Critical components information	N/A

6	TYPE TEST AND SAMPLE SIZE		P
	Tests are made with the number of cells or batteries specified in Table 1 using cells or batteries that are not more than six months old		P
	Coin cells with resistance $\leq 3 \Omega$ (measured according annex D) are tested according table 1	Not coin cells	N/A
	Unless otherwise specified, tests are carried out in an ambient temperature of $20 \text{ }^\circ\text{C} \pm 5 \text{ }^\circ\text{C}$		P
	The safety analysis of 5.6.1 identify those components of the protection circuit that are critical for short-circuit, overcharge and overdischarge protection		P
	When conducting the short-circuit test, consideration given to the simulation of any single fault condition that is likely to occur in the protecting circuit that would affect the short-circuit test	See clause 7.3.2.	P

7	SPECIFIC REQUIREMENTS AND TESTS		P
7.1	Charging procedure for test purposes		P
7.1.1	First procedure		P
	This charging procedure applies to subclauses other than those specified in 7.1.2		P
	Unless otherwise stated in this document, the charging procedure for test purposes is carried out in an ambient temperature of $20 \text{ }^\circ\text{C} \pm 5 \text{ }^\circ\text{C}$, using the method declared by the manufacturer	See page 3.	P
	Prior to charging, the battery have been discharged at $20 \text{ }^\circ\text{C} \pm 5 \text{ }^\circ\text{C}$ at a constant current of 0,2 It A down to a specified final voltage	See page 3.	P
7.1.2	Second procedure		P
	This charging procedure applies only to 7.3.1, 7.3.4, 7.3.5, and 7.3.9		P

IEC 62133-2: 2017			
Clause	Requirement + Test	Result - Remark	Verdict
	After stabilization for 1 h and 4 h, respectively, at ambient temperature of highest test temperature and lowest test temperature, as specified in Table 2, cells are charged by using the upper limit charging voltage and maximum charging current, until the charging current is reduced to 0,05 It A, using a constant voltage charging method	Charge temperature specified by manufacturer: 0-45°C. 0°C used for lower limit tests. 45°C used for upper limit tests.	P
7.2	Intended use		P
7.2.1	Continuous charging at constant voltage (cells)		P
	Fully charged cells are subjected for 7 days to a charge using the charging method for current and standard voltage specified by the cell manufacturer	Charging for 7days with 37mA.	P
	Results: No fire. No explosion. No leakage.....:	(See appended table 7.2.1)	P
7.2.2	Case stress at high ambient temperature (battery)		N/A
	Oven temperature (°C).....:		—
	Results: No physical distortion of the battery case resulting in exposure of internal protective components and cells		N/A
7.3	Reasonably foreseeable misuse		P
7.3.1	External short-circuit (cell)	Tested complied.	P
	The cells were tested until one of the following occurred:		P
	- 24 hours elapsed; or		N/A
	- The case temperature declined by 20 % of the maximum temperature rise		P
	Results: No fire. No explosion.....:	(See appended table 7.3.1)	P
7.3.2	External short-circuit (battery)	Tested complied.	P
	The batteries were tested until one of the following occurred:		P
	- 24 hours elapsed; or		N/A
	- The case temperature declined by 20 % of the maximum temperature rise		P
	In case of rapid decline in short circuit current, the battery pack remained on test for an additional one hour after the current reached a low end steady state condition		P
	A single fault in the discharge protection circuit conducted on one to four (depending upon the protection circuit) of the five samples before conducting the short-circuit test	Single fault conducted on three samples.	P
	A single fault applies to protective component parts such as MOSFET, fuse, thermostat or positive temperature coefficient (PTC) thermistor	Single fault applies on MOSFET U2.	P
	Results: No fire. No explosion.....:	(See appended table 7.3.2)	P

IEC 62133-2: 2017			
Clause	Requirement + Test	Result - Remark	Verdict
7.3.3	Free fall	Tested complied.	P
	Results: No fire. No explosion	No fire. No explosion	P
7.3.4	Thermal abuse (cells)	Tested complied.	P
	Oven temperature (°C) : 130°C		—
	Results: No fire. No explosion	No fire. No explosion	P
7.3.5	Crush (cells)	Tested complied.	P
	The crushing force was released upon:		P
	- The maximum force of 13 kN ± 0,78 kN has been applied; or		P
	- An abrupt voltage drop of one-third of the original voltage has been obtained		N/A
	Results: No fire. No explosion..... : (See appended table 7.3.5)		P
7.3.6	Over-charging of battery	Tested complied.	P
	The supply voltage which is:		P
	- 1,4 times the upper limit charging voltage presented in Table A.1 (but not to exceed 6,0 V) for single cell/cell block batteries or	5.88V applied.	P
	- 1,2 times the upper limit charging voltage resented in Table A.1 per cell for series connected multi-cell batteries, and		N/A
	- Sufficient to maintain a current of 2,0 It A throughout the duration of the test or until the supply voltage is reached		P
	Test was continued until the temperature of the outer casing:		P
	- Reached steady state conditions (less than 10 °C change in 30-minute period); or		N/A
	- Returned to ambient		P
	Results: No fire. No explosion..... : (See appended table 7.3.6)		P
7.3.7	Forced discharge (cells)	Tested complied.	P
	If the discharge voltage reaches the negative value of upper limit charging voltage within the testing duration, the voltage is maintained at the negative value of the upper limit charging voltage by reducing the current for the remainder of the testing duration		N/A
	If the discharge voltage does not reach the negative value of upper limit charging voltage within the testing duration, the test is terminated at the end of the testing duration		P
	Results: No fire. No explosion..... : (See appended table 7.3.7)		P
7.3.8	Mechanical tests (batteries)		P
7.3.8.1	Vibration	Tested complied.	P

IEC 62133-2: 2017			
Clause	Requirement + Test	Result - Remark	Verdict
	Results: No fire, no explosion, no rupture, no leakage or venting. :	(See appended table 7.3.8.1)	P
7.3.8.2	Mechanical shock	Tested complied.	P
	Results: No leakage, no venting, no rupture, no explosion and no fire :	(See appended table 7.3.8.2)	P
7.3.9	Design evaluation –Forced internal short-circuit (cells)		N/A
	The cells complied with national requirement for :	The applicant declares that this cell isn't to be sold in France, Japan, Republic of Korea and Switzerland.	—
	The pressing was stopped upon:		N/A
	- A voltage drop of 50 mV has been detected; or		N/A
	- The pressing force of 800 N (cylindrical cells) or 400 N (prismatic cells) has been reached		N/A
	Results: No fire :	(See appended table 7.3.9)	N/A

8	INFORMATION FOR SAFETY		P
8.1	General		P
	Manufacturers of secondary cells ensure that information is provided about current, voltage and temperature limits of their products	Information for safety mentioned in manufacturer's specifications.	P
	Manufacturers of batteries ensure that equipment manufacturers and, in the case of direct sales, end-users are provided with information to minimize and mitigate hazards	Information for safety mentioned in manufacturer's specifications.	P
	Systems analyses performed by device manufacturers to ensure that a particular battery design prevents hazards from occurring during use of a product		N/A
	As appropriate, any information relating to hazard avoidance resulting from a system analysis provided to the end user		N/A
	Do not allow children to replace batteries without adult supervision		N/A
8.2	Small cell and battery safety information	Small batteries.	P
	The following warning language is to be provided with the information packaged with the small cells and batteries or equipment using them:	Information for safety mentioned in manufacturer's specifications.	P
	- Keep small cells and batteries which are considered swallowable out of the reach of children		P
	- Swallowing may lead to burns, perforation of soft tissue, and death. Severe burns can occur within 2 h of ingestion		P

IEC 62133-2: 2017			
Clause	Requirement + Test	Result - Remark	Verdict
	- In case of ingestion of a cell or battery, seek medical assistance promptly		P
9	MARKING		P
9.1	Cell marking	The final product is battery	N/A
	Cells marked as specified in IEC 61960, except coin cells		N/A
	Coin cells whose external surface area is too small to accommodate the markings on the cells show the designation and polarity		N/A
	By agreement between the cell manufacturer and the battery and/or end product manufacturer, component cells used in the manufacture of a battery need not be marked		N/A
9.2	Battery marking		P
	Batteries marked as specified in IEC 61960, except for coin batteries	See marking plate on page 2.	P
	Coin batteries whose external surface area is too small to accommodate the markings on the batteries show the designation and polarity. Batteries also marked with an appropriate caution statement		N/A
	Terminals have clear polarity marking on the external surface of the battery	The "+ (Red)" and "- (Black)" polarity explicitly marked on surface of the battery.	P
	Batteries with keyed external connectors designed for connection to specific end products need not be marked with polarity markings if the design of the external connector prevents reverse polarity connections		N/A
9.3	Caution for ingestion of small cells and batteries		N/A
	Coin cells and batteries identified as small batteries according to 8.2 include a caution statement regarding the hazards of ingestion in accordance with 8.2	Not coin cells.	N/A
	When small cells and batteries are intended for direct sale in consumer-replaceable applications, caution for ingestion given on the immediate package	Not intended for direct sale.	N/A
9.4	Other information		P
	Storage and disposal instructions	Information for storage and disposal instructions mentioned in manufacturer's specifications.	P
	Recommended charging instructions	Information for recommended charging instructions mentioned in manufacturer's specifications.	P

IEC 62133-2: 2017

Clause	Requirement + Test	Result - Remark	Verdict
--------	--------------------	-----------------	---------

10	PACKAGING AND TRANSPORT		P
	Packaging for coin cells not small enough to fit within the limits of the ingestion gauge of Figure 3	Not coin cells.	N/A
	The materials and packaging design are chosen so as to prevent the development of unintentional electrical conduction, corrosion of the terminals and ingress of environmental contaminants		P

ANNEX A	CHARGING AND DISCHARGING RANGE OF SECONDARY LITHIUM ION CELLS FOR SAFE USE		P
A.1	General		P
A.2	Safety of lithium ion secondary battery	Complied.	P
A.3	Consideration on charging voltage	Complied.	P
A.3.1	General		P
A.3.2	Upper limit charging voltage	4.2V applied.	P
A.3.2.1	General		P
A.3.2.2	Explanation of safety viewpoint		N/A
A.3.2.3	Safety requirements, when different upper limit charging voltage is applied	4.2V applied.	N/A
A.4	Consideration of temperature and charging current		P
A.4.1	General		P
A.4.2	Recommended temperature range	See A.4.2.2.	P
A.4.2.1	General		P
A.4.2.2	Safety consideration when a different recommended temperature range is applied	Charging temperature range declared by client is: 0-45 °C	P
A.4.3	High temperature range	Not higher than the temperature specific in this standard.	N/A
A.4.3.1	General		N/A
A.4.3.2	Explanation of safety viewpoint		N/A
A.4.3.3	Safety considerations when specifying charging conditions in the high temperature range		N/A
A.4.3.4	Safety considerations when specifying a new upper limit in the high temperature range		N/A
A.4.4	Low temperature range	Charging low temperature declared by client is: 0 °C	P
A.4.4.1	General		P
A.4.4.2	Explanation of safety viewpoint		P

IEC 62133-2: 2017			
Clause	Requirement + Test	Result - Remark	Verdict
A.4.4.3	Safety considerations, when specifying charging conditions in the low temperature range		P
A.4.4.4	Safety considerations when specifying a new lower limit in the low temperature range	No documents provided by manufacturer explaining the lower limit exceed 10°C -5°C applied for testing in this report for safety considerations.	P
A.4.5	Scope of the application of charging current		P
A.4.6	Consideration of discharge		P
A.4.6.1	General		P
A.4.6.2	Final discharge voltage and explanation of safety viewpoint	Cell specified final voltage 2.75V, not exceed 2.75V specified by cell manufacturer.	P
A.4.6.3	Discharge current and temperature range		P
A.4.6.4	Scope of application of the discharging current		P
A.5	Sample preparation		N/A
A.5.1	General		N/A
A.5.2	Insertion procedure for nickel particle to generate internal short		N/A
A.5.3	Disassembly of charged cell		N/A
A.5.4	Shape of nickel particle		N/A
A.5.5	Insertion of nickel particle in cylindrical cell		N/A
A.5.5.1	Insertion of nickel particle in winding core		N/A
A.5.5.2	Marking the position of the nickel particle on both ends of the winding core of the separator		N/A
A.5.6	Insertion of nickel particle in prismatic cell		N/A
A.6	Experimental procedure of the forced internal short-circuit test		N/A
A.6.1	Material and tools for preparation of nickel particle		N/A
A.6.2	Example of a nickel particle preparation procedure		N/A
A.6.3	Positioning (or placement) of a nickel particle		N/A
A.6.4	Damaged separator precaution		N/A
A.6.5	Caution for rewinding separator and electrode		N/A
A.6.6	Insulation film for preventing short-circuit		N/A
A.6.7	Caution when disassembling a cell		N/A
A.6.8	Protective equipment for safety		N/A
A.6.9	Caution in the case of fire during disassembling		N/A
A.6.10	Caution for the disassembling process and pressing the electrode core		N/A

IEC 62133-2: 2017			
Clause	Requirement + Test	Result - Remark	Verdict
A.6.11	Recommended specifications for the pressing device		N/A
ANNEX B	RECOMMENDATIONS TO EQUIPMENT MANUFACTURERS AND BATTERY ASSEMBLERS		N/A
ANNEX C	RECOMMENDATIONS TO THE END-USERS		N/A
ANNEX D	MEASUREMENT OF THE INTERNAL AC RESISTANCE FOR COIN CELLS		N/A
D.1	General	Not coin cells.	N/A
D.2	Method		N/A
	A sample size of three coin cells is required for this measurement..... :	(See appended table D.2)	N/A
	Coin cells with an internal resistance of less than or equal to 3 Ω are subjected to the testing according to Clause 6 and Table 1		N/A
	Coin cells with an internal resistance greater than 3 Ω require no further testing		N/A
ANNEX E	PACKAGING AND TRANSPORT		N/A
ANNEX F	COMPONENT STANDARDS REFERENCES		N/A

Attachment 1: Critical components information					P
Object / part No.	Manufacturer / trademark	Type / model	Technical data	Standard	Mark(s) of conformity ¹⁾
Cell		402030	3.7V, 185mAh	IEC 62133-2: 2017	Tested with appliance
- Positive electrode	Dangsheng	LCO-12B	LiCoO ₂ , PVDF, Conductive Additive, Aluminum Foil	--	--
- Negative electrode	Sinuo	MAG-4	Graphite, CMC, SBR, Conductive Additive, Copper Foil	--	--
- Electrolyte	Tianci	TC-EDJ02	LiPF ₆ +EMC+EC+DMC	--	--
- Separator	Saidio	PE	Shutdown temperature: 135°C	--	--
PCB	Interchangeable	Interchangeable	V-0, 130°C	UL 796	UL approved
Protective IC (U1)	Shenzhen Developer Microelectronics Co., Ltd	DW01	V _{CU} : 4.25V~4.35V, V _{DL} : 2.4V~2.6V	--	Tested with appliance
MOSFET (U2)	Shenzhen Developer Microelectronics Co., Ltd	8205A	V _{DSS} : 20V, V _{GS} : ±12V, I _D : 5A	--	Tested with appliance
Lead wire	Interchangeable	Interchangeable	32AWG, 80°C, 30V	UL 758	UL approved
Tape	Interchangeable	Interchangeable	130°C	UL 510	UL approved
Supplementary information:					
¹⁾ Provided evidence ensures the agreed level of compliance. See OD-CB2039.					

7.2.1 TABLE: Continuous charging at constant voltage (cells)				P
Sample no.	Recommended charging voltage Vc (Vdc)	Recommended charging current I _{rec} (mA)	OCV before test (Vdc)	Results
Cell #1	4.20	37	4.19	P
Cell #2	4.20	37	4.18	P
Cell #3	4.20	37	4.19	P
Cell #4	4.20	37	4.17	P
Cell #5	4.20	37	4.18	P

Supplementary information:
 - No fire or explosion
 - No leakage

7.3.1 TABLE: External short-circuit (cell)					P
Sample no.	Ambient T (°C)	OCV before test (Vdc)	Resistance of circuit (mΩ)	Maximum case temperature rise ΔT , °C	Results
Samples charged at charging temperature upper limit (45°C)					
Cell #1	55.2	4.18	82	104.2	P
Cell #2	55.2	4.18	78	101.5	P
Cell #3	55.2	4.18	75	106.7	P
Cell #4	55.2	4.19	81	103.1	P
Cell #5	55.2	4.19	82	104.4	P
Samples charged at charging temperature lower limit (-5°C)					
Cell #6	55.2	4.13	81	100.5	P
Cell #7	55.2	4.12	77	102.4	P
Cell #8	55.2	4.13	80	98.6	P
Cell #9	55.2	4.14	84	99.4	P
Cell #10	55.2	4.13	82	101.7	P

Supplementary information:
 - No fire or explosion

7.3.2 TABLE: External short-circuit (battery)						P
Sample no.	Ambient T (C)	OCV before test (Vdc)	Resistance of circuit (mΩ)	Maximum case temperature rise ΔT , °C	Component single fault condition	Results
Battery #1	23.0	4.19	81	92.4	Short circuit MOSFET U2	P
Battery #2	23.0	4.19	79	94.5	Short circuit MOSFET U2	P
Battery #3	23.0	4.18	77	92.2	Short circuit MOSFET U2	P
Battery #4	23.0	4.19	80	24.5	--	P
Battery #5	23.0	4.18	82	24.6	--	P
Supplementary information: - No fire or explosion						

7.3.5 TABLE: Crush (cells)				P
Sample no.	OCV before test (Vdc)	OCV at removal of crushing force (Vdc)	Maximum force applied to the cell during crush (kN)	Results
Samples charged at charging temperature upper limit (45°C)				
Cell #1	4.19	4.19	13.02	P
Cell #2	4.18	4.18	13.05	P
Cell #3	4.18	4.18	13.03	P
Cell #4	4.19	4.19	13.04	P
Cell #5	4.18	4.18	13.06	P
Samples charged at charging temperature lower limit (-5°C)				
Cell #6	4.14	4.14	13.05	P
Cell #7	4.14	4.14	13.05	P
Cell #8	4.13	4.13	13.04	P
Cell #9	4.14	4.14	13.06	P
Cell #10	4.15	4.15	13.04	P
Note: A 13kN force applied at the wide side of prismatic cells. No voltage abrupt occurred.				
Supplementary information: - No fire or explosion				

7.3.6 TABLE: Over-charging of battery				P
Constant charging current (A)		0.37		—
Supply voltage (Vdc)		5.88		—
Sample no.	OCV before charging (Vdc)	Total charging time (minute)	Maximum outer case temperature (C)	Results
Battery #1	3.32	90	27.5	P
Battery #2	3.33	90	29.7	P
Battery #3	3.35	90	29.2	P
Battery #4	3.34	90	28.5	P
Battery #5	3.33	90	29.6	P
Supplementary information: - No fire or explosion				

7.3.7 TABLE: Forced discharge (cells)				P
Sample no.	OCV before application of reverse charge (Vdc)	Measured reverse charge I_t (mA)	Lower limit discharge voltage (Vdc)	Results
Cell #1	3.31	185	2.75	P
Cell #2	3.32	185	2.75	P
Cell #3	3.32	185	2.75	P
Cell #4	3.33	185	2.75	P
Cell #5	3.32	185	2.75	P
Supplementary information: - No fire or explosion				

7.3.8.1 TABLE: Vibration					P
Sample no.	OCV before test (Vdc)	OCV after test (Vdc)	Mass before test (g)	Mass after test (g)	Results
Battery #1	4.18	4.18	3.692	3.692	P
Battery #2	4.18	4.18	3.614	3.614	P
Battery #3	4.19	4.19	3.689	3.689	P
Supplementary information: - No fire or explosion - No rupture - No leakage - No venting					

7.3.8.2 TABLE: Mechanical shock					P
Sample no.	OCV before test (Vdc)	OCV after test (Vdc)	Mass before test (g)	Mass after test (g)	Results
Battery #1	4.18	4.18	3.721	3.721	P
Battery #2	4.19	4.19	3.641	3.641	P
Battery #3	4.19	4.19	3.656	3.656	P
Supplementary information:					
<ul style="list-style-type: none"> - No fire or explosion - No rupture - No leakage - No venting 					

7.3.9 TABLE: Forced internal short circuit (cells)					P
Sample no.	Chamber ambient T (°C)	OCV before test (Vdc)	Particle location ¹⁾	Maximum applied pressure (N)	Results
Samples charged at charging temperature upper limit (45°C)					
Cell #1	45	4.18	1	400	P
Cell #2	45	4.17	1	400	P
Cell #3	45	4.18	1	400	P
Cell #4	45	4.19	1	400	P
Cell #5	45	4.18	1	400	P
Samples charged at charging temperature lower limit (-5°C)					
Cell #6	-5	4.12	1	400	P
Cell #7	-5	4.14	1	400	P
Cell #8	-5	4.13	1	400	P
Cell #9	-5	4.14	1	400	P
Cell #10	-5	4.12	1	400	P
Supplementary information:					
¹⁾ Identify one of the following: 1: Nickel particle inserted between positive and negative (active material) coated area. 2: Nickel particle inserted between positive aluminium foil and negative active material coated area. - No fire or explosion					

D.2 TABLE: Internal AC resistance for coin cells				N/A
Sample no.	Ambient T (°C)	Store time (h)	Resistance Rac (Ω)	Results ¹⁾
Supplementary information:				
¹⁾ Coin cells with internal resistance less than or equal to 3Ω, see test result on corresponding tables				

Attachment 2

Photo Documentation

Product: Li-ion Polymer Battery
Type Designation: 402030

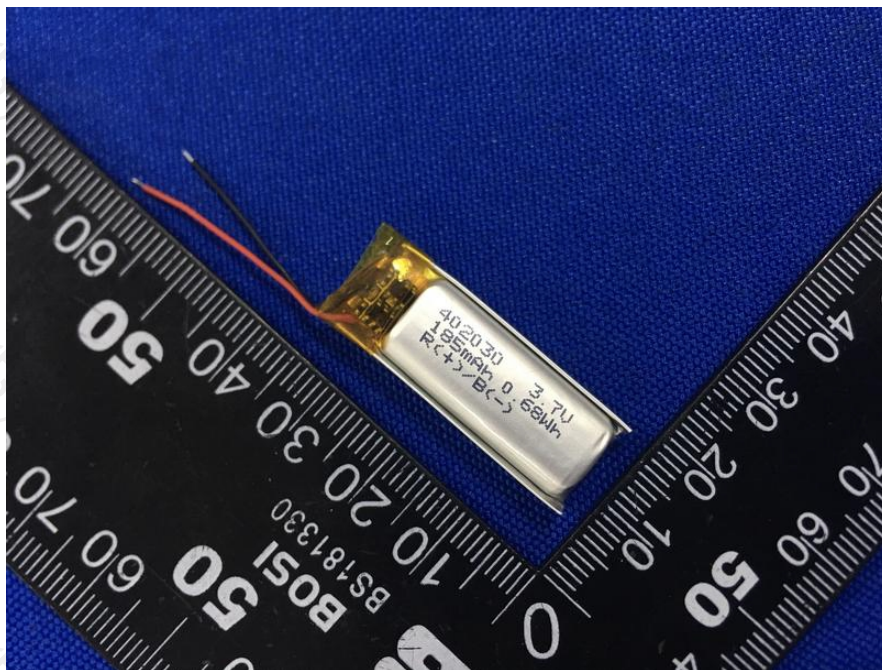

Picture 1. Battery view-1

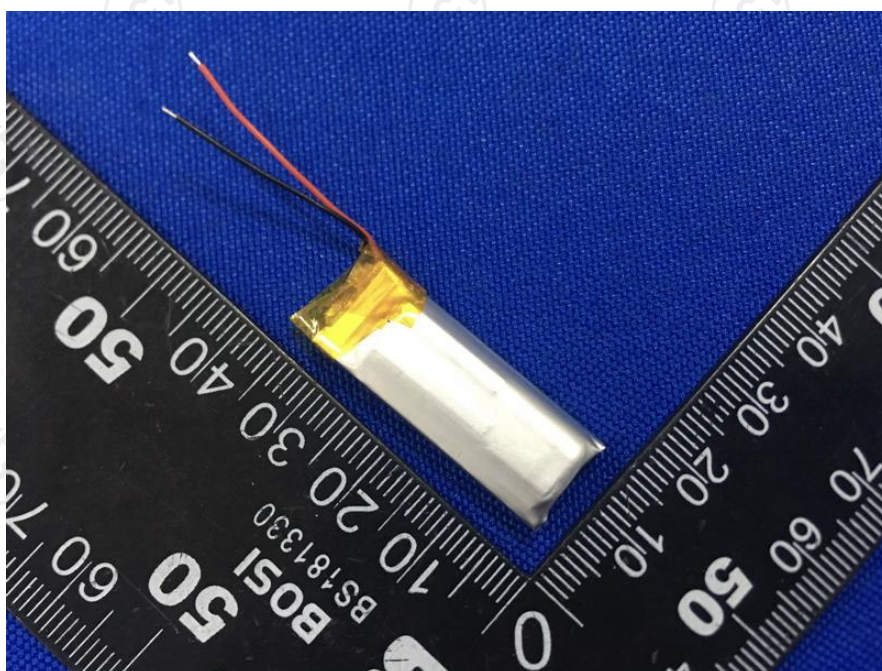

Picture 2. Battery view-2

Photo Documentation

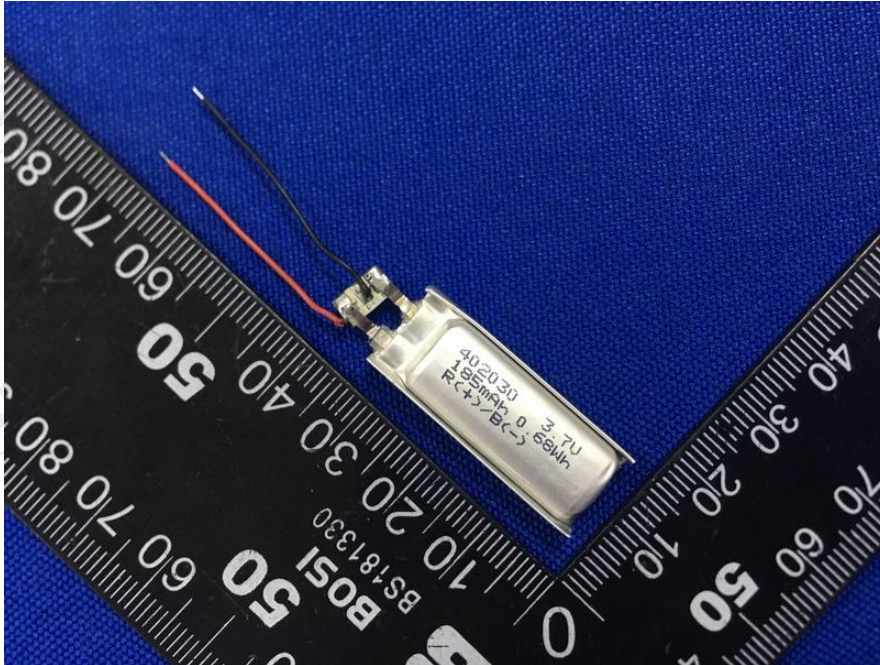

Picture 3. Battery view-3

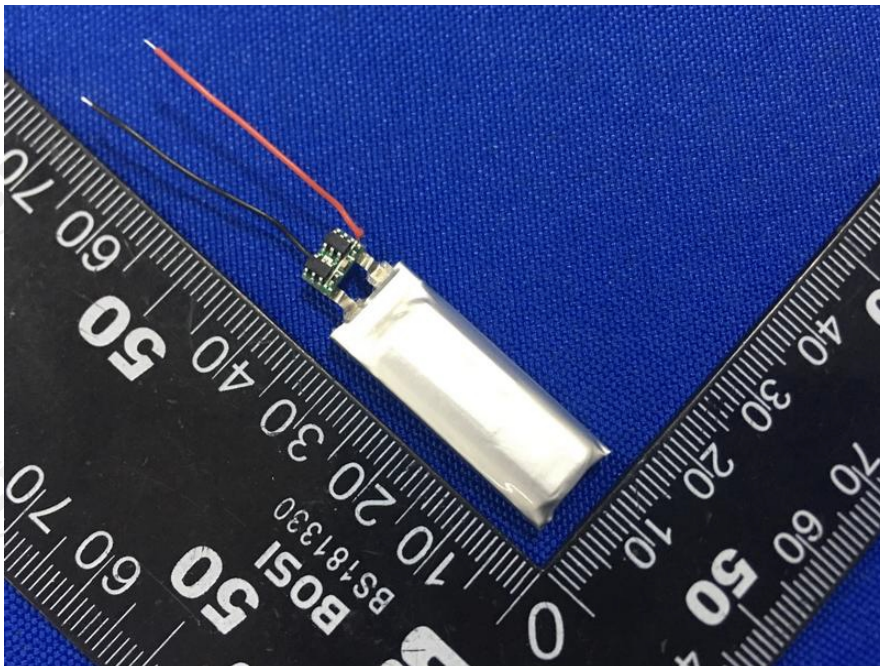

Picture 4. Battery view-4

Photo Documentation

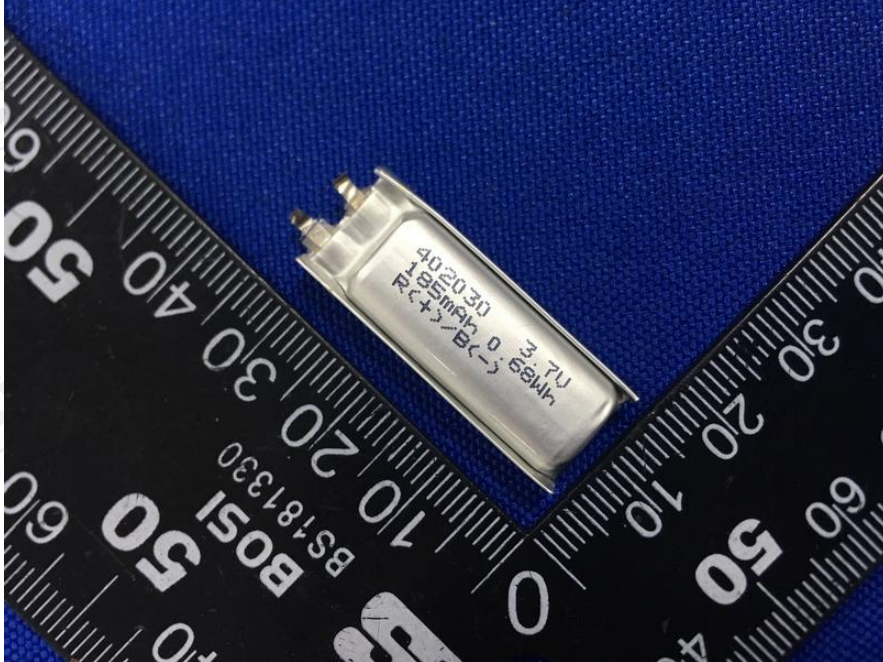

Picture 5. Cell view-1

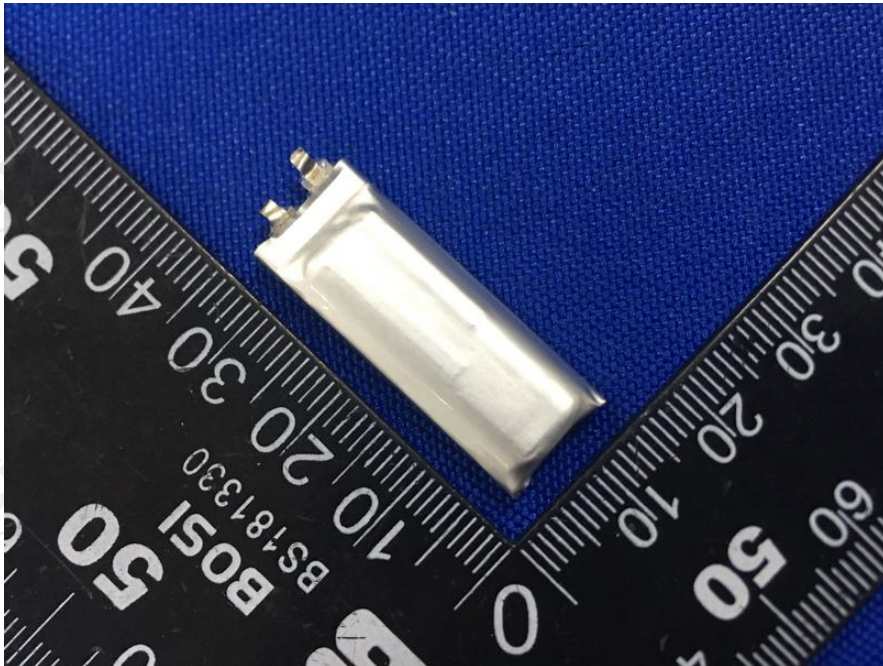

Picture 6. Cell view-2

Photo Documentation

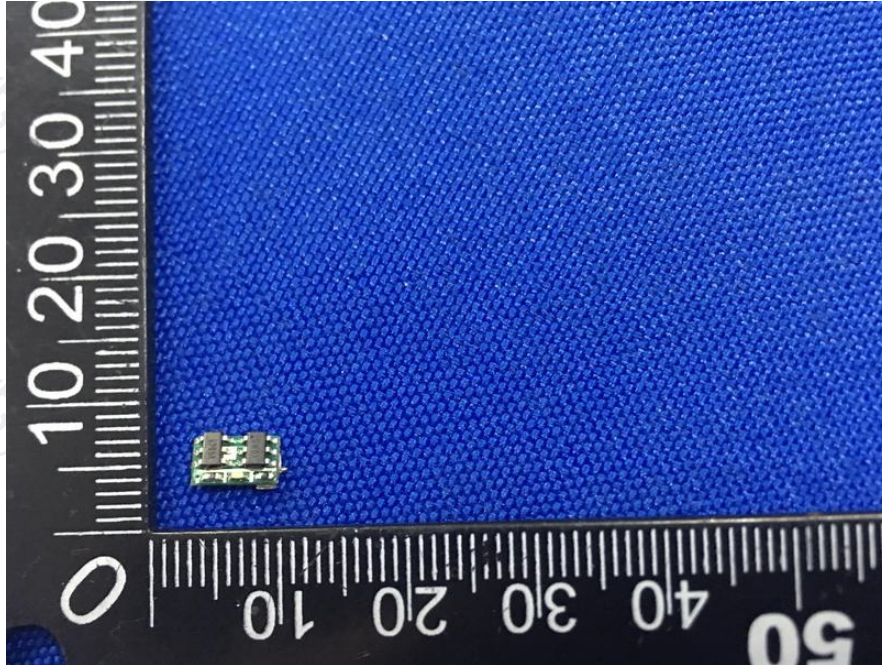

Picture 7. Protection board view-1

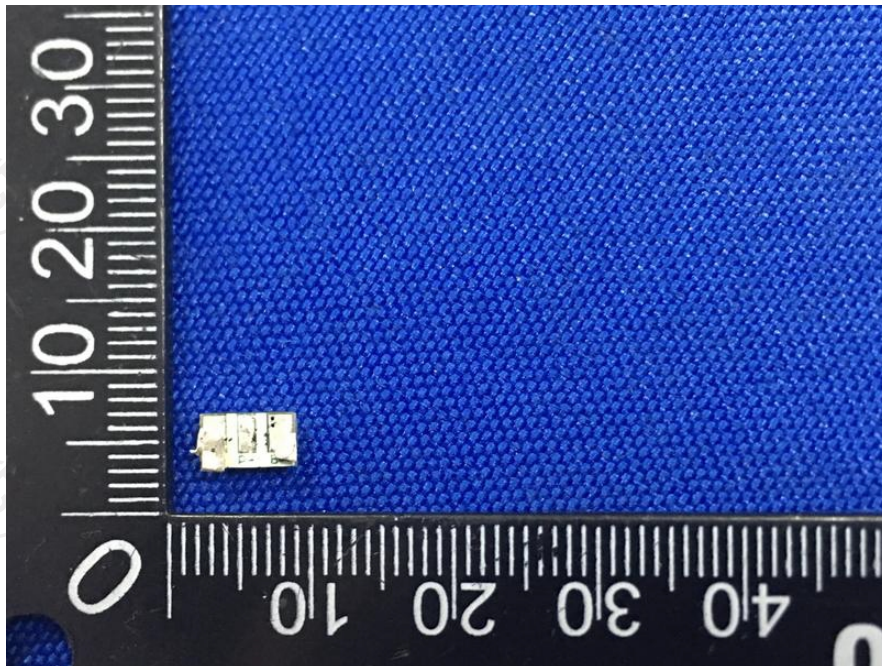

Picture 8. Protection board view-2

***** End of Test Report *****